



# Barracuda CloudGen Firewall

Protecting cloud connected users, network workloads and devices wherever they reside

Product Overview



# Table of contents

ABOUT BARRACUDA NETWORKS . . . . .	3	HARDWARE FACTS . . . . .	25	FEATURES AND CAPABILITIES (continued)	
BARRACUDA CLOUDGEN FIREWALL . . . . .	4	Model comparison . . . . .	25	Barracuda CloudGen Firewall (continued)	
PERIMETER SECURITY . . . . .	6	Specifications - Entry and branch office models	26	Additional functions . . . . .	79
Full application awareness . . . . .	6	CloudGen Firewall F12A. . . . .	26	DNS . . . . .	79
Deep application context . . . . .	6	CloudGen Firewall F18B. . . . .	27	Authoritative DNS Server . . . . .	80
Custom application definitions . . . . .	6	CloudGen Firewall F80B . . . . .	28	DHCP . . . . .	80
Application-based routing. . . . .	6	CloudGen Firewall F180B . . . . .	29	Mail security . . . . .	80
Real-time application reporting & manipulation .6		CloudGen Firewall F280C. . . . .	30	Web proxy . . . . .	81
Application risk and usage report . . . . .	7	Specifications - Mid-range models . . . . .	31	Rest API extensions. . . . .	81
Full user identity awareness. . . . .	7	CloudGen Firewall F380B. . . . .	31	Cloud-specifics . . . . .	81
Web security. . . . .	8	CloudGen Firewall F400C standard model . . . . .	32	Zero Trust Access. . . . .	81
Advanced Threat Protection. . . . .	8	CloudGen Firewall F400C.F20 . . . . .	33	Advanced Remote Access . . . . .	82
Botnet and spyware protection . . . . .	8	CloudGen Firewall F600D.C10 . . . . .	34	Remote & Network Access Clients . . . . .	82
Typo squatting & link protection for email . . . . .	9	CloudGen Firewall F600D.C20 . . . . .	35	CudaLaunch . . . . .	83
Web filtering . . . . .	9	CloudGen Firewall F600D.F10. . . . .	36	Barracuda Firewall Control Center . . . . .	84
Safe Search enforcement . . . . .	9	CloudGen Firewall F600D.F20 . . . . .	37	Configuration management . . . . .	84
Google Apps accounts enforcement . . . . .	9	CloudGen Firewall F600D.E20 . . . . .	38	Status monitoring . . . . .	84
Mail security . . . . .	9	Specifications - High-level models . . . . .	39	Trust center. . . . .	84
Malware protection. . . . .	10	CloudGen Firewall F800C.CCC . . . . .	39	License center . . . . .	84
File content enforcement. . . . .	10	CloudGen Firewall F800C.CCF . . . . .	40	Central software update. . . . .	85
Network security . . . . .	11	CloudGen Firewall F800C.CCE . . . . .	41	Secure remote exec. environment (SSHv2) . . . . .	85
Intrusion detection and prevention . . . . .	11	CloudGen Firewall F900B.CCC . . . . .	42	Administrative model . . . . .	85
DoS/DDoS attack protection . . . . .	11	CloudGen Firewall F900B.CCE . . . . .	43	Reporting and accounting. . . . .	85
CLOUD AUTOMATION . . . . .	12	CloudGen Firewall F900B.CFE . . . . .	44	Additional functions. . . . .	85
Fast user experience and improved application performance . . . . .	12	CloudGen Firewall F900B.CFEQ . . . . .	45	AVAILABLE SUBSCRIPTIONS . . . . .	87
Multi-tier security . . . . .	12	CloudGen Firewall F1000B.CE0 . . . . .	46	Availability matrix. . . . .	87
Flexible licensing and consumption models. . . . .	12	CloudGen Firewall F1000B.CE2 . . . . .	47	Energize Updates . . . . .	87
Enhancing ExpressRoute and Direct Connect security . . . . .	13	CloudGen Firewall F1000B.CFE . . . . .	48	Barracuda Firewall Insights . . . . .	88
Supported public-cloud offerings and available deployment sizes . . . . .	14	CloudGen Firewall F1000B.CFEQ . . . . .	49	On-Site Cold Spare Unit . . . . .	88
SD-WAN AND PERFORMANCE . . . . .	15	Specifications - DIN Rail Mountable / Rugged Models . . . . .	50	Warranty Extension. . . . .	89
Optimized direct internet break out for SaaS . . . . .	15	CloudGen Firewall F93A.R . . . . .	50	Instant Replacement . . . . .	89
WAN compression . . . . .	15	CloudGen Firewall F193A.R . . . . .	51	Comparison "Warranty Extension - Instant Replacement" . . . . .	89
Failover and link balancing . . . . .	15	Secure Connector 20 . . . . .	52	Premium Support. . . . .	90
Dynamic bandwidth detection and performance-based transport selection . . . . .	16	Secure Connector 21 . . . . .	53	Advanced Remote Access . . . . .	90
Adaptive bandwidth reservation . . . . .	16	Secure Connector 24 . . . . .	54	Advanced Threat Protection . . . . .	91
Adaptive session balancing . . . . .	16	Secure Connector 25 . . . . .	55	Malware Protection. . . . .	91
Dynamic forward error correction. . . . .	16	Secure Connector 30 . . . . .	56	ORDERING INFORMATION . . . . .	92
On-demand dynamic mesh SD-WAN . . . . .	16	Secure Connector 31 . . . . .	57	Barracuda CloudGen Firewall. . . . .	92
Azure Virtual WAN . . . . .	16	Secure Connector 34 . . . . .	58	Hardware appliances - Entry level / branch offices . . . . .	92
ZERO TRUST ACCESS . . . . .	17	Secure Connector 35 . . . . .	59	Hardware appliances - Mid-range . . . . .	93
UNIFIED REMOTE ACCESS . . . . .	18	ADDITIONAL HARDWARE OPTIONS. . . . .	60	Hardware appliances - High-end . . . . .	96
ONCE-ONLY CENTRAL MANAGEMENT . . . . .	21	Built-in Wi-Fi option. . . . .	60	Hardware appliances - DIN-rail compatible . . . . .	99
Lifecycle management . . . . .	21	Spare power supply unit . . . . .	60	Virtual Appliances. . . . .	101
Scalable deployment. . . . .	22	Barracuda L-shape rack mount bracket . . . . .	60	Amazon Web Services (AWS) . . . . .	101
Cloud deployment . . . . .	22	USB modem . . . . .	61	Microsoft Azure . . . . .	101
Lifecycle automation . . . . .	22	APPLIANCE MEASUREMENTS . . . . .	62	Google Cloud Platform . . . . .	102
Zero-touch deployment . . . . .	22	VIRTUAL APPLIANCES . . . . .	72	Barracuda Firewall Control Center . . . . .	103
Enterprise- and service provider licensing . . . . .	22	FEATURES AND CAPABILITIES . . . . .	73	Virtual Edition. . . . .	103
Comparison of Barracuda Firewall Control Center models . . . . .	23	Barracuda CloudGen Firewall. . . . .	73	Microsoft Azure . . . . .	103
ANALYTICS AND REPORTING. . . . .	24	Firewall. . . . .	73	Amazon Web Services (AWS) . . . . .	103
Information is key . . . . .	24	Application control . . . . .	74	Google Cloud Platform (GCP) . . . . .	103
Central reporting instance . . . . .	24	Intrusion prevention system . . . . .	75	Barracuda Firewall Insights . . . . .	103
Central log aggregator . . . . .	24	Malware protection . . . . .	76	Firewall Insights Server (Virtual Edition) . . . . .	103
Advanced definition, automatic generation, and reliable delivery . . . . .	24	Advanced threat protection . . . . .	76	Firewall Insights Server Subscription . . . . .	103
		Web filter . . . . .	77	CERTIFICATES . . . . .	104
		Traffic intelligence & SD-WAN . . . . .	77	CE Declaration of Conformity. . . . .	104
		Routing & networking . . . . .	78	UN 38.3 Compliance . . . . .	105
		Remote access . . . . .	78		
		System management . . . . .	79		
		Logging/monitoring/accounting . . . . .	79		



# About Barracuda Networks

Barracuda Networks provides cloud-connected security and storage solutions that simplify IT. These powerful, easy-to-use, and affordable solutions are trusted by more than 200,000 organizations worldwide. Barracuda's expansive product portfolio delivers protection against threats targeting email, web, and network intrusions, as well as products that improve application delivery, network access, message archiving, backup, and data protection, on-premises or in the cloud.

Barracuda's high-value, subscription-based IT solutions provide end-to-end network and data security that helps customers address security threats, improve network performance, and protect and store their data.

Barracuda's international headquarters are in the heart of northern California's Silicon Valley.

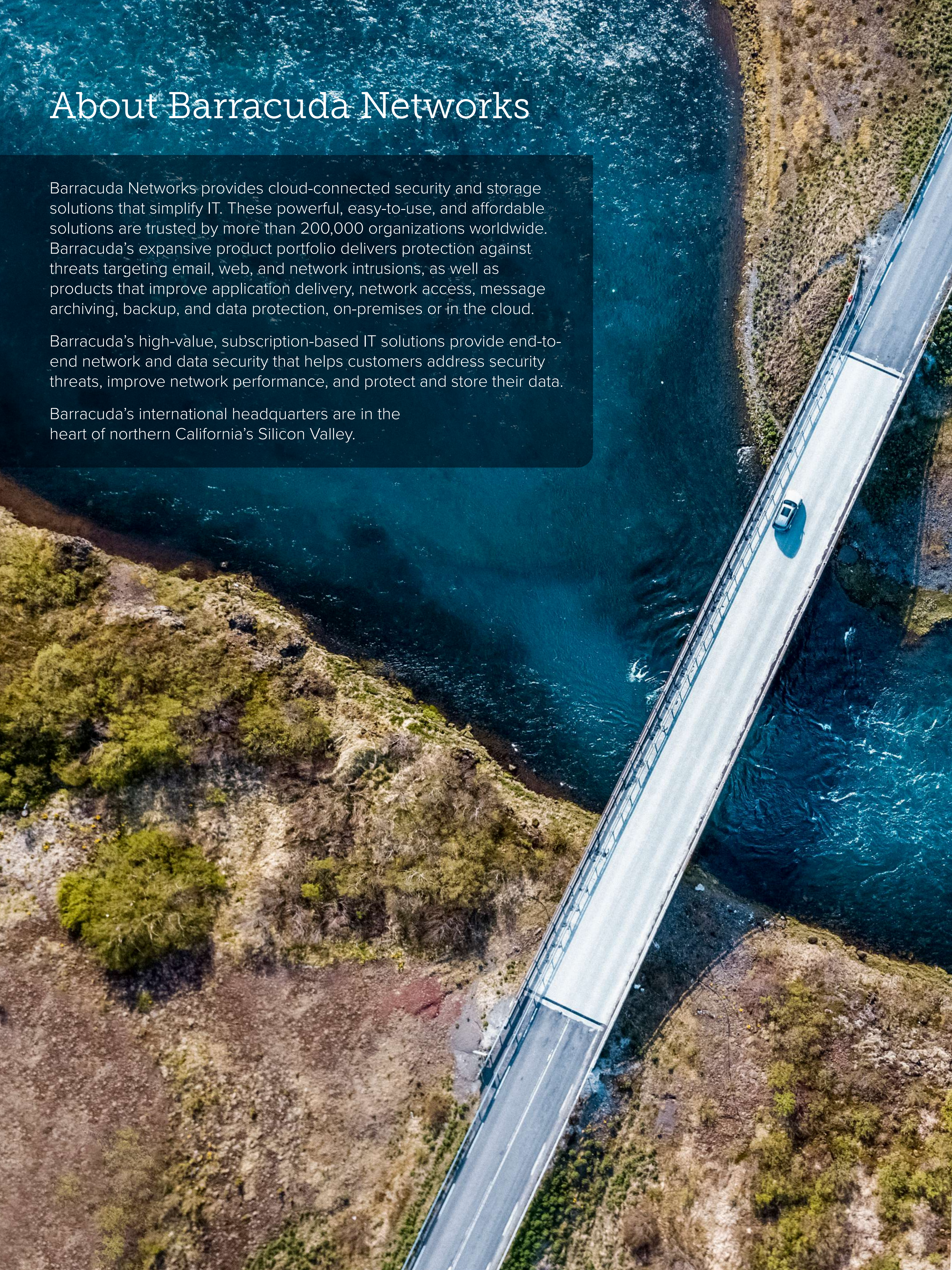



# Barracuda CloudGen Firewall

## The first cloud-generation firewall

More and more companies all over the world adopt and integrate public cloud offerings into their network. But “before you can work in the cloud, you have to get to cloud” has never been more true than today.

Shifting workloads to cloud based services, regardless if Software as a Service (SaaS), Platform as a Service (PaaS) or Infrastructure as a service (IaaS) exposed a different set of requirements WAN edge and network security devices today need to address: Optimizing connectivity for business critical applications, enforcing higher security levels than ever and reducing cost by moving away from expensive MPLS lines.

Because traditional WAN edge and security products did not adapt to these new challenges, a new set of solutions enabling cost efficient connectivity across the cloud-enabled WAN has emerged: SD-WAN.

However, SD-WAN typically does not address security-related aspects. It is considered more like a connectivity solution that works besides the security solution - at best. Just like different species.

Barracuda CloudGen Firewall is the first to combine full next-generation security with the connectivity optimization and cost savings potentials of a full SD-WAN solution onto one single easy to manage hardware, virtual or cloud based appliance. CloudGen Firewall improves site-to-site connectivity and enables uninterrupted access to applications hosted in the cloud all while simplifying the administration of network operations for enterprises and managed services providers.

CloudGen Firewall achieves this by tightly integrating a comprehensive set of next-generation firewall technologies, including layer 7 application profiling, intrusion prevention, web filtering, advanced threat and malware protection, spam protection, and network access control. On top of these next generation firewall capabilities, CloudGen Firewall’s specialized and highly resilient remote access technology outperforms any other SD-WAN.

All pieces of the solution are centrally manageable across all platforms and release versions, reducing ongoing administrative overhead and ensuring policy compliance and enforcement across the wide area network.

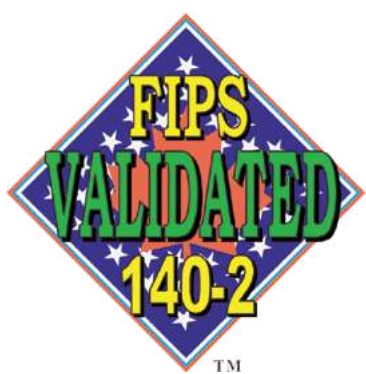

## Benefits at a glance

**Consolidated security without compromise:** All CloudGen Firewall models and deployment options provide comprehensive next-generation firewalling including [application control](#) and [user awareness](#), full mail & [web security gateway](#) functionality, [malware protection](#), [botnet and spyware detection](#), [typosquatting & link protection](#), [sandboxing \(Advanced Threat Protection\)](#), [URL filter](#), and [file type policy enforcement](#). All this combined with unbeatable [network security](#) and packed into a single, powerful appliance, virtual or public cloud image. The tight integration of web security and network security features enables advanced functionalities, such as prioritizing certain application traffic based on user/group info and time information, and allowing certain applications to go out via predefined uplinks only.

**Cloud ready:** The ongoing shift of IT workloads to cloud services requires a reliable, cost-effective [extension of the company WAN](#) to the cloud. This applies to headquarters as well as direct Internet breakouts at every branch location. CloudGen Firewall models come fully featured for [all common cloud IaaS providers](#), as virtual appliances, and in a variety of hardware appliances for even small offices. Hybrid WAN and cloud-only networks can thereby also benefit from CloudGen Firewall.

**Secure SD-WAN capabilities:** Significantly increase uplink capacity and application performance by aggregating up to 24 active, [load-sharing connections](#) of any type (broadband, 4G, MPLS between locations). Dynamic packet loss prevention, traffic compression, and application acceleration increase available bandwidth far beyond the sum of all available physical uplinks combined. Dynamic, on-the-fly adjustments of QoS and application usage policies depending on [dynamic bandwidth measurement](#) make sure there will always be enough bandwidth for business-critical applications. And with [zero-touch deployment](#) even the largest rollouts are easy to execute.

**ZTNA and remote access:** For traditional remote access requirements via encrypted connectivity Barracuda CloudGen Firewall includes [zero-touch for remote access](#), unified remote-access clients for macOS, Windows, iOS, and Android devices to make sure employees enjoy fast and reliable access to the corporate network. The Barracuda CloudGen Firewall enables fast Zero Trust Network Access (ZTNA) roll-outs with [Barracuda CloudGen Access](#) with the included CloudGen Access Proxy service on the firewall. This enables fast deployment of ZTNA for all types of applications without the need for separate installation of proxy services or back-hauling of confidential customer data via a third party web solution.

**Once-only central management:** The entire CloudGen Firewall infrastructure, regardless if only a few devices or a couple thousand distributed across thousands of locations and multiple deployment types, can be deployed, managed and monitored from a single pane of glass through the [Barracuda Firewall Control Center](#). Managing several thousands of firewalls requires the same effort as managing one firewall.

**Unparalleled cost savings:** CloudGen Firewall consolidates security, SD-WAN, link balancing, and WAN compression disciplines into a single appliance that provides significant cost savings due to the reduction or elimination of expensive leased lines and consolidation of security devices. Even for small rollouts of only a few devices, customers achieve a return of investment after just a few months with potential savings of hundreds of thousands of dollars over the next years.

**Analytics and reporting:** Staying secure and seamlessly connected requires you to have up-to-date data. The vast amount of data coming from different origins and in different formats often needs manual processing, an approach that is both error prone and costly. [Barracuda Firewall Insights](#) automates these challenging tasks.



# Perimeter security

## Full application awareness

Mobile devices, online applications, social networks, and streaming media have caused an enormous increase in non-business network data traffic, pushing bandwidth capacities to their limits and causing degradation in performance of business-critical applications. Application control built into every Barracuda CloudGen Firewall allows admins to accurately identify and control thousands of protocols and applications (like software updates, BitTorrent, Skype, instant messaging etc.) crossing the network and not visible with regular port-based firewalls. CloudGen Firewall gives administrators granular control over applications. They can define rules for forwarding application traffic using the most suitable uplink based on type of application, user, content, available bandwidth, link status, time of day, and even geographical location. Unsanctioned applications can be reliably blocked or bandwidth throttled to an acceptable level.

## Deep application context

Deep application context analysis enables deeper inspection of the application data stream by continually evaluating the actual intentions of applications and the respective users. For example, if a user attempts to use an application like “HydeMyAss” privacy VPN to bypass traditional web filtering, Barracuda CloudGen Firewall cannot only block the application itself, but also report the website the user originally attempted to connect to. [For more details, please click here...](#)

## Custom application definitions

On top of thousands of applications that are delivered out of the box and constantly updated, Barracuda CloudGen Firewall provides an easy way to create user-defined application definitions. For example, admins can allow just a very limited set of Facebook apps while blocking all others, or assign more bandwidth to homegrown or legacy business systems. [For more details, please click here...](#)

## Application-based routing

A unique combination of next-generation security and adaptive WAN routing technology allows CloudGen Firewall to dynamically assign available bandwidth, uplink, and routing information based not only on protocol, user, location, and content, but also on applications, application categories, and even web content categories. This keeps expensive, highly available lines free for business- and mission-critical applications, while significantly reducing response times and freeing up additional bandwidth.

[For more details, please click here...](#)

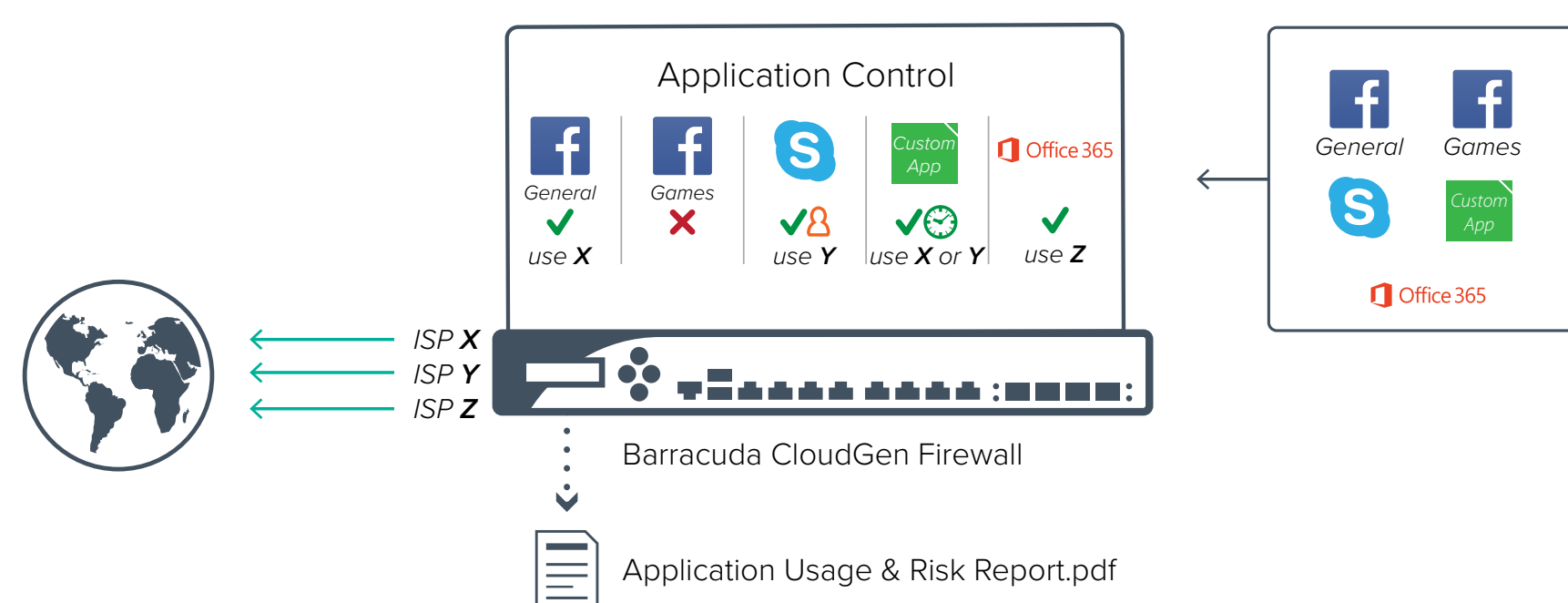

Figure 1 - Application-based routing with Barracuda CloudGen Firewall

## Real-time application reporting and manipulation

For on-the-fly reporting and drill-down capabilities, Barracuda CloudGen Firewall comes with real-time and historical application visibility that show live and recent application traffic on the corporate network that can be interactively filtered and drilled down. This helps admins to decide which application connections should be given bandwidth prioritization and who is currently violating acceptable use policies.

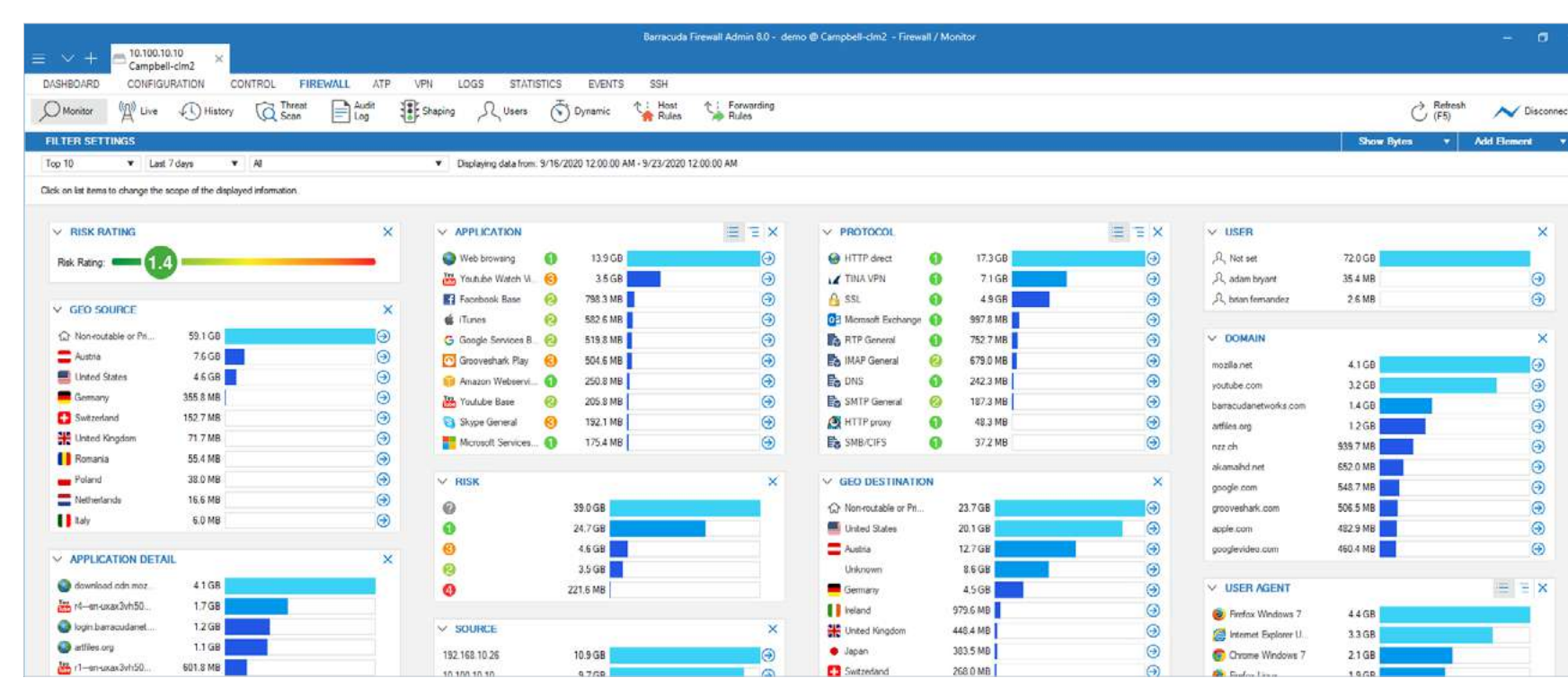

Figure 2 - Real-time application reporting



### Application risk and usage report

The application usage and risk report is one of many predefined reports in the included Barracuda Firewall Report Creator tool that provides automated reports and risk analysis based on the network traffic traversing the network. It gives an overview of how effective the currently deployed policies are in detecting and enforcing corporate application usage policies and even provides recommendations of what actions should be taken to improve these policies.

Barracuda CloudGen Firewall can easily be deployed risk free into existing networks to collect data required for generating such reports by using either a layer-2 network bridge or SPAN port / port mirroring deployment. No matter what method is used, collecting the traffic has no impact on the firewall performance at all.

Creating reports can be started manually (on-demand) or scheduled (including automated email distribution). And - of course - reports are fully customizable to comply with possible branding requirements.



#### Top Application Traffic traversing the Network

The Barracuda NG Firewall provides powerful and extremely reliable detection and classification of applications and sub-applications by combining Deep Packet Inspection (DPI) and behavioral traffic analysis - no matter if the protocols are using advanced obfuscation, port hopping techniques or encryption. The Barracuda NG Firewall comes with real-time and historical application visibility that shows application traffic on the corporate network. This provides a basis for deciding which connections should be given bandwidth prioritization, which is crucial for QoS optimization of business-critical applications. Furthermore, it allows for adjusting and refining the corporate application use policy.

Barracuda Networks provides a risk rating for any identified application and protocol crossing the network. Based in the conducted traffic analysis the overall risk rating is as follows:

Mister Y Application Traffic Risk Rating:



The following chart provides an overview of the top applications based on bandwidth consumption that are traversing the network of Mister Y:

#	APPLICATIONS	RISK	TRAFFIC	SESSIONS
1	Web browsing	1	10.9 GB	1232613
2	Microsoft Update	1	4.2 GB	4602
3	Google Play Base	2	495.1 MB	1511
4	Google Services Base	2	194.7 MB	3633
5	Amazon Webservices	1	180.7 MB	108
6	iTunes	2	179.4 MB	81
7	Apple Update	1	173.3 MB	3
8	Avira AV Update	1	134.3 MB	260
9	Facebook Base	2	78.9 MB	1016
10	Bing Search	1	33.1 MB	500
11	Google Safe Browsing	1	29.2 MB	228
12	Ubuntu Update	1	27.0 MB	15
13	Google Update	1	18.1 MB	11
14	Microsoft Account	1	13.8 MB	637
15	iCloud Base	2	12.2 MB	413
16	MSN General	3	9.5 MB	4512
17	OneDrive	4	8.7 MB	209
18	Youtube Watch Video	3	7.6 MB	10
19	Ooyala	3	6.6 MB	21
20	Google AdSense	3	5.3 MB	152

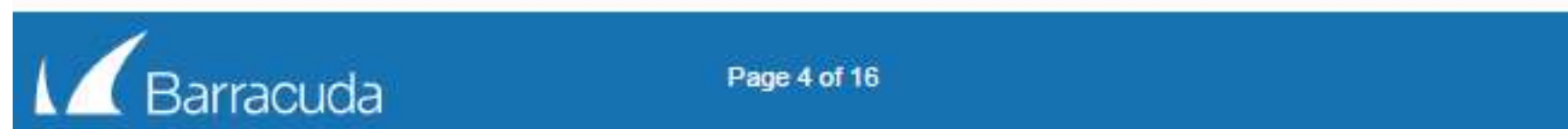

Figure 3 - Example for an application risk and usage report

### Full user identity awareness

Barracuda CloudGen Firewall combines application control with seamless support for all commonly used authentication schemes such as Azure AD, active directory, RADIUS, and LDAP/S. That means reporting can be done based on user and group membership (instead of source IP addresses), and firewall and application policy rules can easily be created for individual users and groups.

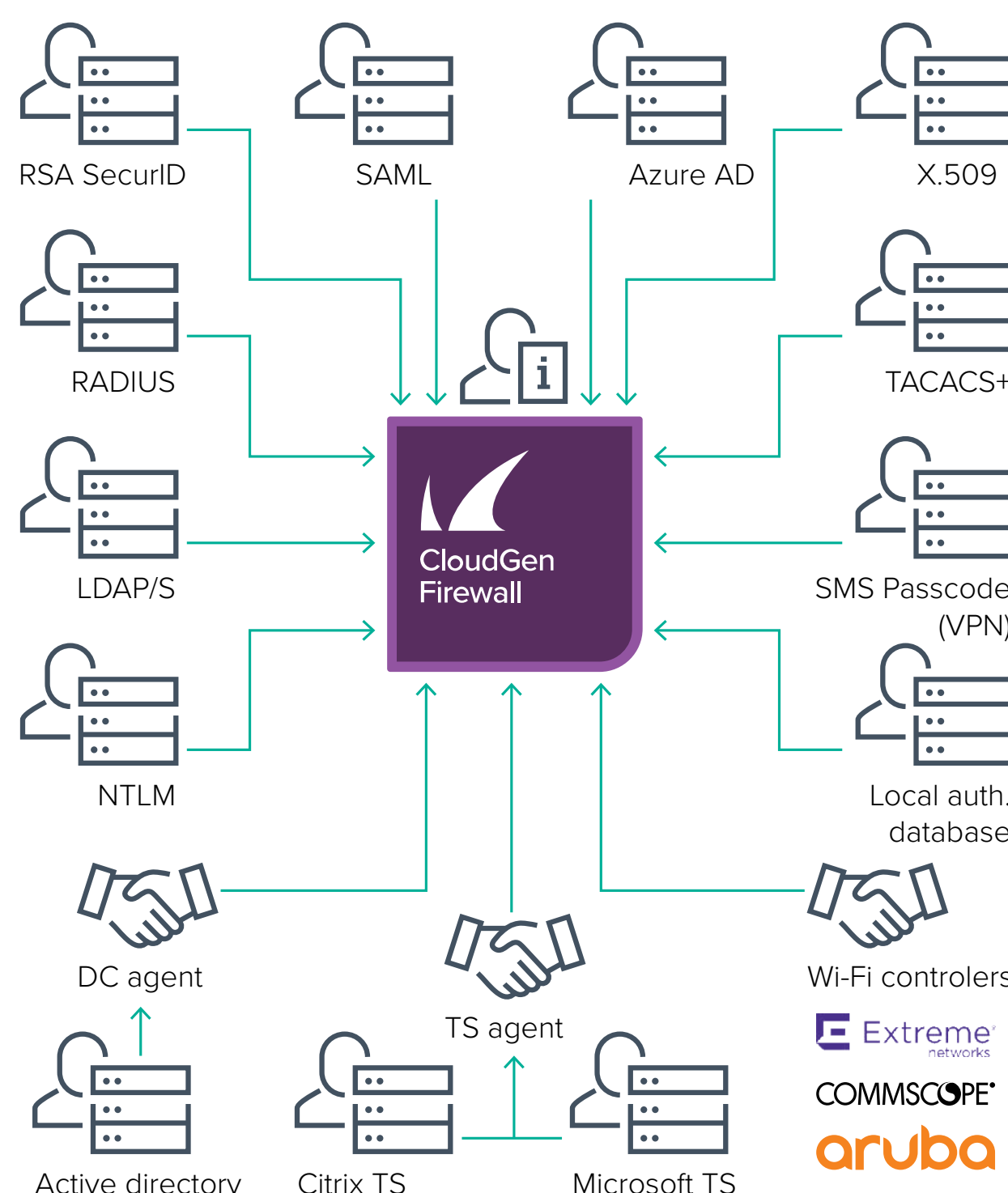

Figure 4 - Seamless support for commonly used authentication schemes



## Web security

### Advanced Threat Protection

Barracuda Advanced Threat Protection (ATP) uses next-generation sandbox technology including full-system emulation to catch advanced persistent threats, zero-day malware, and all advanced malware designed specifically to evade detection. ATP on Barracuda CloudGen Firewall ensures flexible and simple deployment into existing networks because no additional hardware is required. Resource-intensive sandboxing is offloaded to the Barracuda ATP Cloud with its multiple datacenters in the Americas, mainland Europe, UK, Japan, and Singapore. A hash fingerprint of each file and the good/bad classification of all sandboxed files are stored and cached for future use, effectively speeding up processing and guaranteeing near instantaneous results. Over 95% of all files checked by the ATP service have typically been seen before and only very few files need processing.

Since the Barracuda ATP cloud database cache is continuously updated by hundreds of thousands of CloudGen Firewall and CloudGen WAN deployments, Email Security Gateways, Web Security Gateways and Barracuda Email Protection services, the ATP service provides a true worldwide early detection grid for newly emerging malware.

With ATP on CloudGen Firewall, the firewall administrator has full policy control over how PDF documents, Microsoft Office Files, EXEs/MSIs/DLLs, Android APKs, compressed files, and archives are emulated and delivered to the client. Based on identified malware activity, infected users can be automatically quarantined, thereby preventing the malware from spreading within the network. Customizable, on-demand analysis reports for any emulated file provide full insight and details on malicious activities, file behavior, system-registry entries, and evasion and obfuscation techniques.

This also enables network activities such as establishing encrypted connections to botnet command and control centers for increased security posture to evade scaled botnet attacks.



Figure 5 - Barracuda Advanced Threat Protection architecture

### Botnet and spyware protection

In combination with the ATP cloud database, all CloudGen Firewall models and deployment types provide protection against botnet infections and detect potentially infected clients based on DNS requests. Once an infected client is detected, it can be isolated automatically, and an alert can be created or reported with the [Barracuda Firewall Report Creator](#).



## Typo squatting & link protection for email

This important feature of ATP adds protection for two rising threats: uncovering misleading and misspelled links.

The link protection component automatically rewrites deceptive URLs in email messages to a Barracuda-validated URL and informs the requesting user on this change via a warning page displaying all the details about the blocked URL.

Typo squatting is a common trick to fool users into clicking on a link to a known source although the link is misspelled (e.g., examlpe.com), comes with a different top-level domain (e.g., example.org), or contains special characters (e.g., greek character rho for “p” - example.com), etc.

## Web filtering

Web filtering on CloudGen Firewall is included with the Energize Updates subscription and enables highly granular, real-time visibility into online activity, broken down by individual users and applications, thereby letting administrators create and enforce effective Internet content and access policies.

Web filter functionality with CloudGen Firewall protects user productivity, blocks malware downloads and other web-based threats, enables compliance by blocking access to inappropriate websites and servers, and provides an additional layer of security alongside application control.

[For more details, please click here...](#)

## Safe Search enforcement

Many search engines have a safe search setting that filters out adult search results such as inappropriate images and videos in search query return traffic. On CloudGen Firewall customers can easily activate Safe Search enforcement so that the firewall will enforce safe search settings for all common search providers such as Google, Yahoo, and Bing, and even within YouTube. Search engines not supported can easily be blocked.

This functionality is even effective within SSL-encrypted search engines like google.com if SSL Inspection (included with all Barracuda CloudGen Firewall models and deployment types) is activated.

## Google Apps accounts enforcement

In some cases, users with their own Google Apps account may be able to circumvent Safe Search enforcement settings by logging in from their workstation with their own Google Apps account. To prevent this, all CloudGen Firewall models and deployment types enforce and limit Google Apps accounts logins only for a list of predefined apps accounts easily created the administrator.

## Mail security

Mail is still one of the most common ways of spreading malware. CloudGen Firewall includes all necessary means to prevent incoming email to the corporate mail server from being infected.

CloudGen Firewall’s mail security includes malware scanning, Advanced Threat Protection, and basic spam filtering via DNS block-listing of known mail senders and malware domains. [For more details, please click here...](#)



## Malware protection

The optional malware protection shields the internal network from malicious content by scanning web content (HTTP and HTTPS), email (SMTP, POP3), and file transfers (FTP) via two fully integrated antivirus engines. Malware protection is based on regular signature updates as well as heuristics to detect malware or other potentially unwanted programs even before signatures are available. The malware protection covers viruses, worms, trojans, malicious Java applets, and programs using known exploits on PDF, pictures and office documents, macro viruses, and many more, even when using stealth or morphing techniques for obfuscation.

[For more details, please click here...](#)

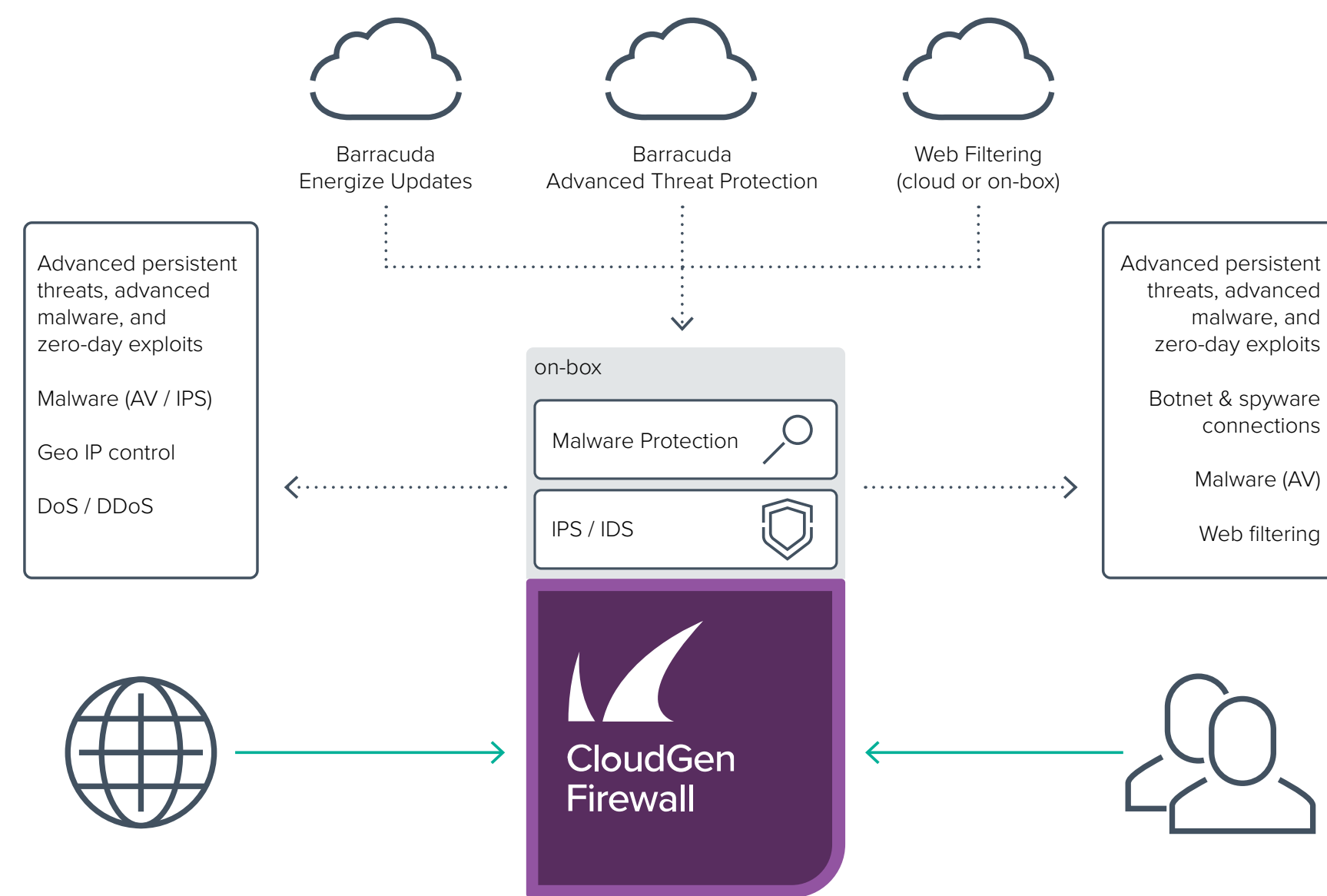

Figure 6 - Multi-layered security architecture

## File content enforcement

Barracuda CloudGen Firewall includes true file type detection and enforcement capabilities based not only on extension and MIME type, but also on sophisticated true file type detection algorithms. Bypassing executable files by renaming or compressing is detected and blocked. Besides blocking / allowing connections, the Barracuda CloudGen Firewall also lets admins change download priorities. For example, if an ISO image started downloading with normal web traffic priority, the admin can increase or decrease the assigned bandwidth for the download, even though the user started downloading via a regular web-browsing session.

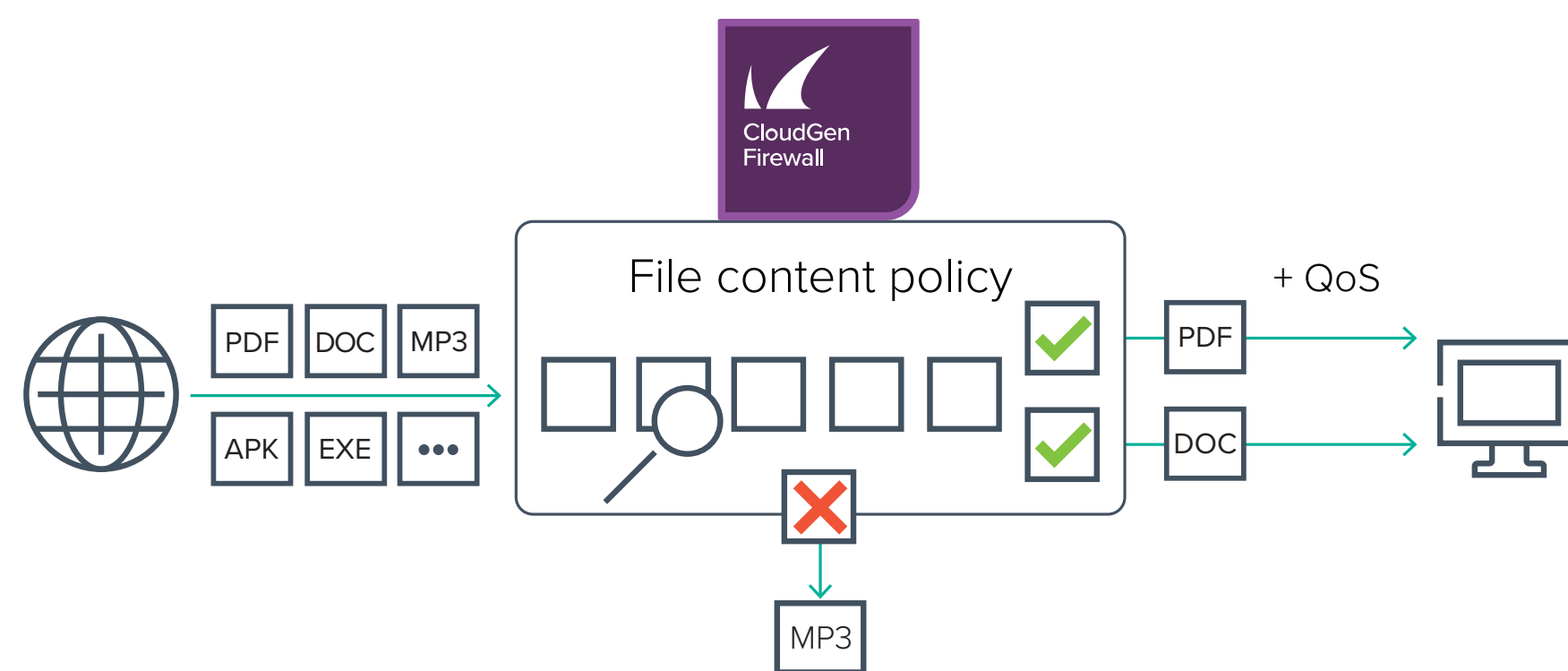

Figure 7 - True file type detection and enforcement



## Network security

### Intrusion detection and prevention

Every CloudGen Firewall includes a built-in intrusion detection and prevention system (IDS/IPS) that provides complete and comprehensive real-time network protection against a broad range of network threats, vulnerabilities, exploits, and exposures in operating systems, applications, and databases, thereby preventing network attacks such as:

- SQL injections and arbitrary code executions
- Access control attempts and privilege escalations
- Cross-site scripting and buffer overflows
- DoS and DDoS attacks
- Directory traversal and probing and scanning attempts
- Backdoor attacks, trojans, rootkits, viruses, worms, and spyware

By providing advanced attack and threat protection features such as stream segmentation and packet anomaly protection, TCP split handshake protection, IP and RPC defragmentation, FTP evasion protection, as well as URL and HTML decoding, CloudGen Firewall can identify and block advanced evasion attempts and obfuscation techniques that are used by attackers to circumvent and trick traditional intrusion prevention systems. As part of Barracuda's Energize Updates subscription automatic IPS signature updates are delivered on a regular schedule or on an emergency basis to ensure that CloudGen Firewall is constantly up-to-date. [For more details, please click here...](#)

### DoS/DDoS attack protection

Every CloudGen Firewall comes with a host of built-in network protection functionalities beyond firewalling and IPS to protect networks and resources against malicious over-exhaustion.

TCP SYN flooding attacks are automatically prevented by predefined connection attempt limits that are configurable separately for outbound and inbound accept policies.

To further guard against regular DoS/DDoS attacks, the maximum number of new sessions and the allowed total number of sessions from a single source can be specified. This protects against resource exhaustion of your firewalls as well as the servers and networks behind them. These settings are configurable on a per-rule basis, thereby ensuring that protected servers with higher loads like web servers may be fully utilized.



# Cloud automation

The big advantage of going to the cloud goes beyond cost savings but in greater agility and flexibility, enabling adoption of a DevOps/Agile methodology, and of cloud-native constructs and automation. Development and deployment processes in the cloud show drastic improvements over on-premises deployments and, thus, require high levels of automation and scripting. All of the components, including infrastructure for security and connectivity, need to adapt to the way this works in the public cloud via API or scripting. CloudGen Firewall provides fully automated protection across multi-cloud deployments, including SD-WAN and remote access automation across multiple cloud providers, on-site and virtual. This is important for DevOps processes that need to automate security, segmentation, and secure remote connectivity.

## Fast user experience and improved application performance

CloudGen Firewall is designed from ground up to secure and optimize access to cloud applications by utilizing a unique combination of link bonding, dynamic application prioritization, application-based uplink selection and traffic compression techniques to improve the WAN network performance to the cloud, regardless of office type or remote mobile locations.

## Multi-tier security

Segmenting cloud networks into multiple tiers provides security, visibility, and compliance for on-premises applications. Additionally, this can be leveraged when the applications are deployed in public cloud environments through Barracuda CloudGen Firewall.

CloudGen Firewall secures, restricts, and monitors the communications between these tiers, and limits the potential damage to an organization in the event of an attack. By filling the functional gaps between cloud infrastructure security and a defense-in-depth strategy, CloudGen Firewall provides protection between the application and data layers, rather than solely where the cloud network starts.

This architecture provides:

- Comprehensive security enforcement inside the cloud
- Threat detection and traffic monitoring between cloud application components
- Secure integration with on-premises resources
- Restricted and encrypted role-based administrative access to application infrastructure
- A mix of cloud-hosted network tiers and on-premises tiers if required by compliance regulations

## Flexible licensing and consumption models

To be able to benefit of the elasticity of a cloud deployment, the licensing aspect has to taken into consideration as well. CloudGen Firewall provides regular Bring-Your-Own-License (BYOL) and highly flexible Pay-As-You-Go (PAYG) licensing based on on hourly (metered) usage.



## Enhancing ExpressRoute and Direct Connect security

Azure ExpressRoute and AWS Direct Connect allow organizations to establish high-performance private connections between Azure datacenters and on-premises infrastructure and provides low latencies, failure-resilient connectivity and consistent predictable performance.

For both public cloud services, CloudGen Firewall enhances security and boosts reliability as well as connectivity performance:

### Security

- Encrypt traffic across ExpressRoute and Direct Connect
- Check traffic for network threats and malware
- Prevent unwanted traffic from entering or leaving the cloud

### Reliability & Performance

- Provide transparent fallback to internet SD-WAN in case of MPLS uplink failure while preserving all running sessions
- Bond ExpressRoute/Direct Connect with up to 24 Internet uplinks using Barracuda TINA remote access technology for significantly enhanced cloud connection

### Intelligence

- Log all traffic for troubleshooting and reporting purposes
- Enforce priorities for protocols and applications utilizing ExpressRoute
- Enforce security policies based on user identity



## Supported public-cloud offerings and available deployment sizes

 For more details on Microsoft Azure and CloudGen Firewall, please visit [barracuda.com/programs/azure](https://barracuda.com/programs/azure).

	MICROSOFT AZURE				
Capabilities	BYOL level 2	BYOL level 4	BYOL level 6	BYOL level 8	PAYG
Virtual Cores	1	2	4	8 to 32	Does not apply
Protected IP addresses	Unlimited	Unlimited	Unlimited	Unlimited	Unlimited
Available consumption models	Bring-Your-Own-Licence (BYOL)				Pay-As-You-Go (PAYG) (time-based)
<b>AVAILABLE SUBSCRIPTIONS</b>					
<a href="#">Barracuda Firewall Insights</a>	Optional	Optional	Optional	Optional	✓
<a href="#">Advanced Threat Protection</a>	Optional	Optional	Optional	Optional	-
<a href="#">Malware Protection</a>	Optional	Optional	Optional	Optional	-
<a href="#">Advanced Remote Access</a>	Optional	Optional	Optional	Optional	✓
<a href="#">Premium Support</a>	Optional	Optional	Optional	Optional	-

 For more details on Amazon Web Services and CloudGen Firewall, please visit [barracuda.com/programs/aws](https://barracuda.com/programs/aws).

	AMAZON WEB SERVICES				
Capabilities	BYOL level 2	BYOL level 4	BYOL level 6	BYOL level 8	PAYG
Virtual Cores	1	2	4	8 to 32	Does not apply
Protected IP addresses	Unlimited	Unlimited	Unlimited	Unlimited	Unlimited
Available consumption models	Bring-Your-Own-Licence (BYOL)				Pay-As-You-Go (PAYG) (time-based)
<b>AVAILABLE SUBSCRIPTIONS</b>					
<a href="#">Barracuda Firewall Insights</a>	Optional	Optional	Optional	Optional	✓
<a href="#">Advanced Threat Protection</a>	Optional	Optional	Optional	Optional	-
<a href="#">Malware Protection</a>	Optional	Optional	Optional	Optional	-
<a href="#">Advanced Remote Access</a>	Optional	Optional	Optional	Optional	✓
<a href="#">Premium Support</a>	Optional	Optional	Optional	Optional	-

 For more details on Google Cloud and CloudGen Firewall, please visit [barracuda.com/programs/googlecloud](https://barracuda.com/programs/googlecloud).

	GOOGLE CLOUD PLATFORM				
Capabilities	BYOL level 2	BYOL level 4	BYOL level 6	BYOL level 8	PAYG
Virtual Cores	1	2	4	8 to 32	Does not apply
Protected IP addresses	Unlimited	Unlimited	Unlimited	Unlimited	Unlimited
Available consumption models	Bring-Your-Own-Licence (BYOL)				Pay-As-You-Go (PAYG) (time-based)
<b>AVAILABLE SUBSCRIPTIONS</b>					
<a href="#">Barracuda Firewall Insights</a>	Optional	Optional	Optional	Optional	✓
<a href="#">Advanced Threat Protection</a>	Optional	Optional	Optional	Optional	-
<a href="#">Malware Protection</a>	Optional	Optional	Optional	Optional	-
<a href="#">Advanced Remote Access</a>	Optional	Optional	Optional	Optional	✓
<a href="#">Premium Support</a>	Optional	Optional	Optional	Optional	-



# SD-WAN and performance

With the increasing adoption of cloud-native applications in today's business environment, the role of the firewall has evolved from a gateway-based, security-only device to a set of distributed solutions that make sure the WAN network is available any time for any type of endpoint. Regardless if the WAN endpoint is at headquarters, a remote office, a network in the IaaS cloud, or a mobile endpoint, Barracuda CloudGen Firewall enables impeccable WAN performance.

Barracuda CloudGen Firewall units deployed to multiple physical and cloud locations allow an organization to create a fault-tolerant, high-performance WAN network on top of low-cost broadband lines by combining full next-gen deep security inspection, smart policy-based adaptive traffic management, and traffic compression technology into a single centrally manageable solution. Besides improved fault tolerance against outages and better WAN performance, the solution enables cost optimization strategies when multiple carriers/ISPs are combined to get the required bandwidth at an optimum price. This section highlights CloudGen Firewall's WAN reliability and performance technologies.

## Optimized direct internet break out for SaaS

Barracuda CloudGen Firewall optimizes access to SaaS applications that require direct internet access. Based on the performance to the Internet, the most responsive uplink is chosen to guarantee fast application performance.

## WAN compression

All Barracuda CloudGen Firewall models include data deduplication and traffic compression. With built-in WAN compression, CloudGen Firewall significantly improves site-to-site WAN network throughput and accelerates the delivery of business applications - at no extra charge.

WAN compression is even included with CloudGen Firewall's virtual and cloud-based deployment options, effectively enabling secure, high-performance direct internet breakouts to cloud-hosted networks for every remote location.

[For more details, please click here...](#)

## Failover and link balancing

Barracuda CloudGen Firewall provides a wide range of built-in uplink options such as leased lines, broadband (DHCP, DSL/cable, PPPoA, PPPoE, PPTP), and 3G/4G/UMTS. Up to 24 uplinks can be combined in load sharing or failover mode, eliminating the need to purchase additional devices for link balancing. CloudGen Firewall's unique combination of application awareness and traffic intelligence mechanisms automatically prioritizes business-critical applications, networks, and even distinct endpoints in case overall remaining bandwidth is degraded. Unlike typical firewall solutions, all uplinks can be utilized to distribute SD-WAN traffic, effectively enabling extremely reliable and encrypted site-to-site connectivity with only inexpensive broadband or even 4G uplinks.

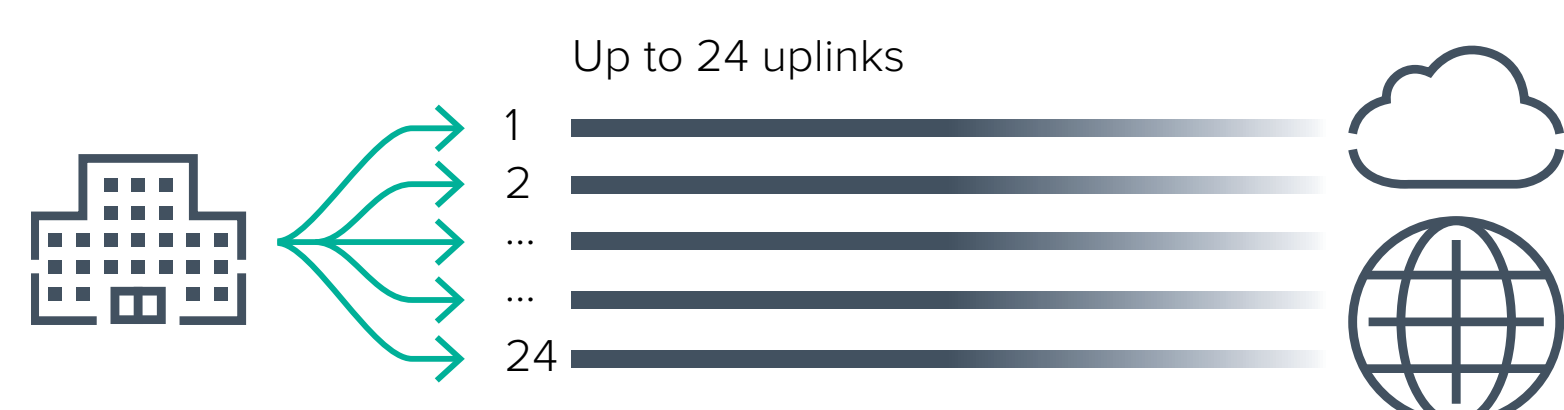

Figure 8 - Combine up to 24 uplinks load sharing or failover mode



## Dynamic bandwidth detection and performance-based transport selection

In order to achieve the highest possible quality of service, all CloudGen Firewall models pro-actively measure the available bandwidths and - automatically - select the best uplink for a SD-WAN connection based on bandwidth, latency, or combined quality metrics.

## Adaptive bandwidth reservation

If a measured bandwidth is not sufficient for business-critical traffic (e.g., VoIP), CloudGen Firewall can automatically adjust the allocated bandwidths for non-business-critical traffic to free up bandwidth for redistribution.

## Adaptive session balancing

Using multiple transports simultaneously might end up in some clogged transports and some hardly used ones. To avoid this inconvenience, CloudGen Firewall can dynamically balance not only newly created sessions but also already existing ones across the available uplinks.

## Dynamic forward error correction

Secure SD-WAN connections with Barracuda CloudGen Firewall are designed for high-speed networking across shared lossy lines such as internet broadband or 4G/5G. The underlying forward error correcting (FEC) technology to remediate packet loss is based on a new set of algorithms in the category of random linear network codes (RLNC). Algorithms based on RLNC codes react much faster to losses, remediate these faster on the fly, requiring fewer packet retransmissions and reducing overhead on the devices. This results in high quality voice and video calls even in high packet loss scenarios and with many subscribers on the shared line.

## On-demand dynamic mesh SD-WAN

CloudGen Firewall deployments in a centrally managed WAN network create SD-WAN connections dynamically based on remote peer and application. The typical use case for this technology is creating an encrypted SD-WAN connections between two branch offices on-demand for a VoIP phone call, thereby improving call quality.

For hybrid networks hosted in public cloud infrastructures like Microsoft Azure, Amazon Web Services, or Google Cloud Platform, this technology can be used easily to enable on-the-fly and direct access to cloud applications from remote offices that otherwise do not need a permanent cloud connection.

## Azure Virtual WAN

CloudGen Firewall supports Microsoft's Azure Virtual WAN technology to allow fast, secure, and uninterrupted network availability with your cloud-hosted or hybrid datacenter and your branch offices through Microsoft's global network. In combination with Virtual WAN, CloudGen Firewall fully enables automated large-scale branch connectivity, selective traffic backhauling, unified networks and policy management, and optimized routing using the Microsoft global network.

- Automatic branch to branch connectivity
- Automatic branch to Microsoft Azure connectivity
- Allow hundreds of remote locations to securely connect via Azure Virtual WAN
- Active-active remote access for uninterrupted connectivity
- Optimal routing and minimal latency for branch-to-branch and branch-to-Azure connectivity with Microsoft's global network
- Unified network and security policy management



# Zero Trust Access

Remote work is here to stay, and as a result, cloud migrations are accelerating and the need to secure and monitor access to public and private business applications is vital. Enterprises are now looking to Zero Trust Access (ZTA; also know as Zero Trust Network Access or in short ZTNA) to verify each attempt by a device or individual to obtain access to resources and company data.

In other words, ZTA describes a paradigm shift around remote access. ZTA requires continuous verification that only the right person, with the right device, and the right permissions can access company data or apps. If all prerequisites are met, ZTA establishes a direct connection to the application without exposing the network, largely reducing the possible attack surface. Creating ZTA environments with traditional VPN solutions and microsegmentation is unreasonably cumbersome, highly error prone and impossible to maintain.

To enable secure direct access to company applications, regardless where they are hosted, Barracuda provides [Barracuda CloudGen Access](#).

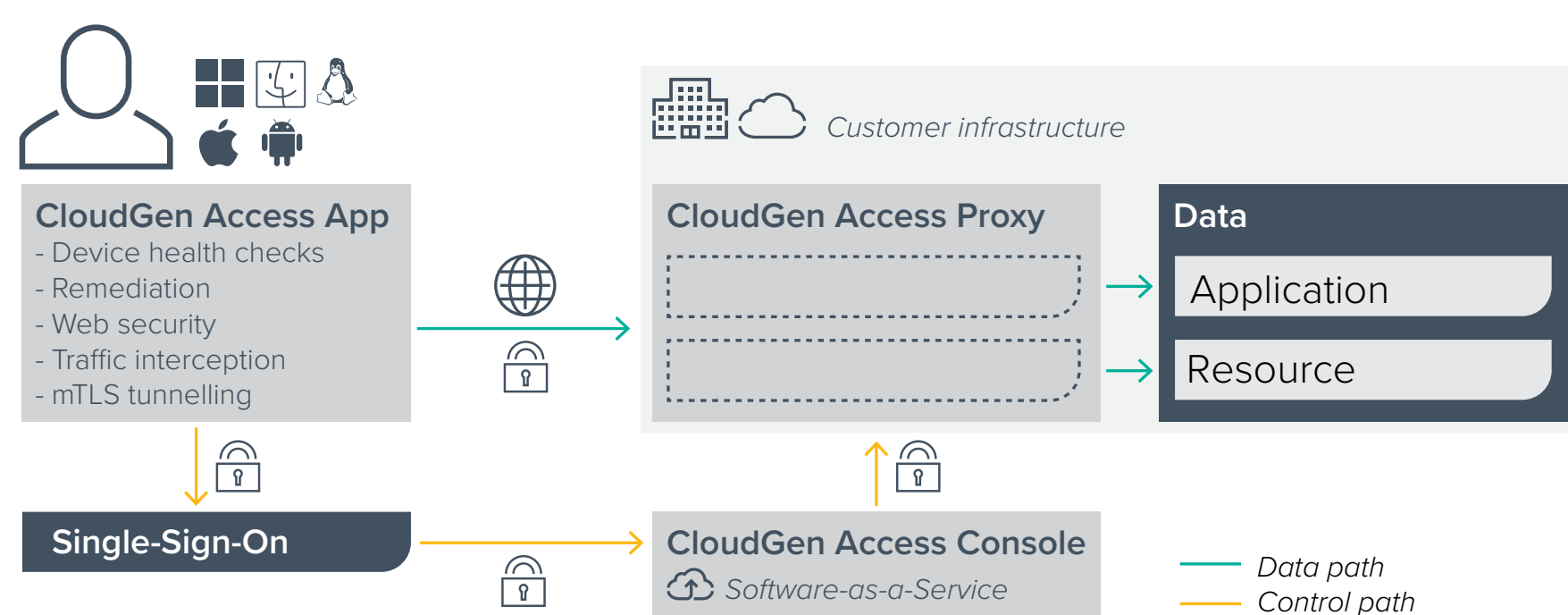

Figure 9 - Zero Trust Access architecture

CloudGen Access zero trust solution supports many customer use cases, including

- Secure single-sign-on access to SaaS apps
- Controlled secure access to apps from BYOD devices
- Simultaneous access to applications on-prem and on multiple clouds
- Provide contractors secured access to company applications regardless where hosted
- DevOps access on multi-cloud environments
- Gain real-time visibility and control over users, devices, and apps
- Mobile device security monitoring and protection against malicious web sites

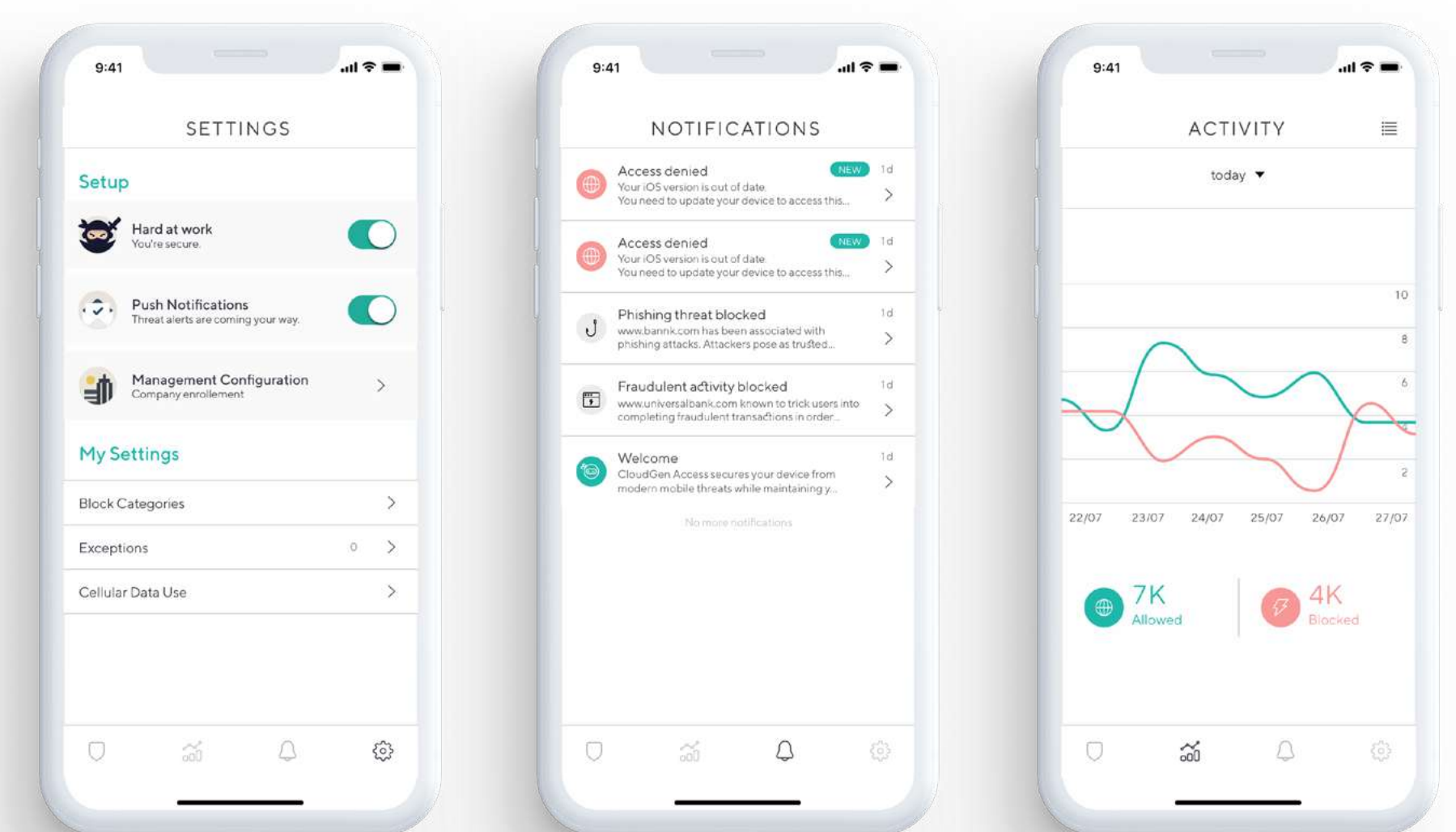

Figure 10 - Various CloudGen Access app impressions

Please note: Zero Trust Access requires a separate subscription for [Barracuda CloudGen Access](#). To facilitate quick rollout of Zero Trust Access, CloudGen Firewall provides the CloudGen Access Proxy service as part of the [Energize Updates](#) subscription.



# Unified remote access

Barracuda CloudGen Firewall incorporates advanced client-to-site access capabilities, using ZTNA, SSL, mTLS, IPsec, and TINA protocols to ensure remote users can easily and securely access network resources without time-consuming client configuration and management. The communication protocols used with our clients are optimized to be fully roaming-capable by quickly reconnecting upon loss of communication. Smart pathfinder technology determines the nearest point of entry to the corporate network. By using different ports encapsulated in either TCP or UDP, the advanced NAT traversal technology can easily pass through web proxies.

CloudGen Firewall provides strong capabilities that give users the full advantage of their devices while reducing possible risks to their business. Unwanted applications can be blocked, LAN segmentation can protect sensitive data, and network access control can check the health state of each device prior to connecting to the corporate network.

For authentication purpose, CloudGen Firewall supports time-based one-time password (TOTP) algorithm (requires an Advanced Remote Access subscription. This allows to streamline the rollout of TOTP solutions using bulk enrollment.

Multi-factor authentication (MFA) provided by all CloudGen Firewall devices with an active Advanced Remote Access subscription provides an additional layer of security.

The widely used time-based-one-time password (TOTP) algorithm ensures wide end user acceptance.

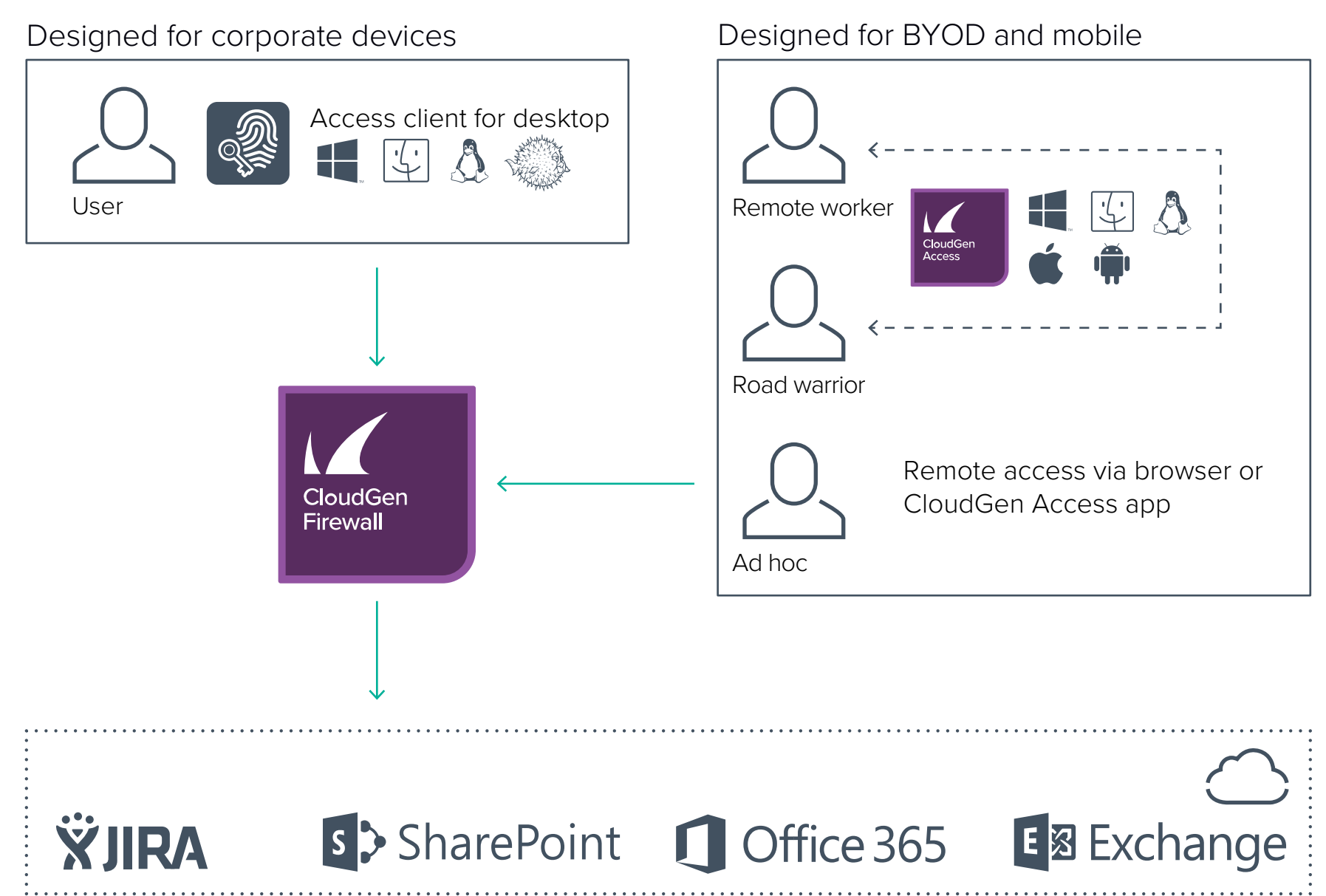

Figure 11 - Secure remote access architecture

## About TINA protocol

The TINA protocol encapsulates encrypted ESP payload in TCP or UDP packets, thus adapting to underlying transport network quality and providing failure resistant, high-speed connections. It also improves remote access substantially by adding:

- Multiple concurrent physical transport paths per logical tunnel
- Session level or packet level transport aggregation for increased total tunnel throughput
- Adaptive traffic shaping depending on SD-WAN transport availability
- Fallback transports in case of uplink failure
- Traffic compression and deduplication
- DHCP and NAT support
- Packet loss mitigation with dynamic forward error correction



## CudaLaunch

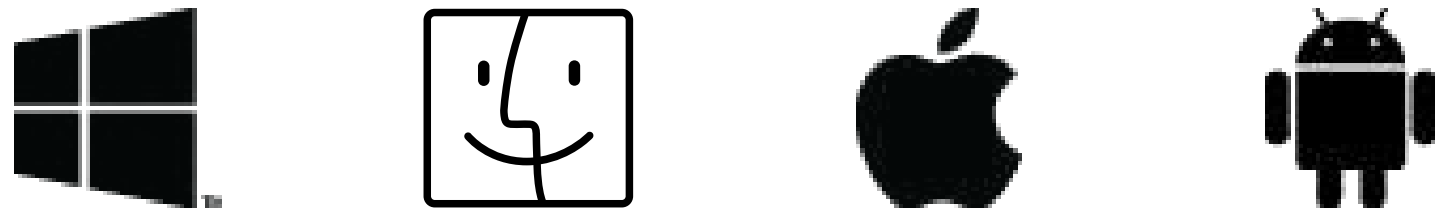

CudaLaunch is a simple-to-use remote connectivity application specifically designed to securely extend the company network to BYOD and mobile devices. The app is available for Windows, macOS, iOS, and Android, can be downloaded from the App Stores. End users can install the app without elevated privileges on the device. CudaLaunch looks and feels the same on every platform and provides fast, Java-independent access to commonly used applications in the company network, regardless if hosted on-premises or in the cloud. CudaLaunch’s zero-touch provisioning and administration features drastically reduce support and administration costs for rapidly changing mobile and BYOD devices.

CudaLaunch is part of the Advanced Remote Access subscription.



CudaLaunch is available for download here:

Mobile

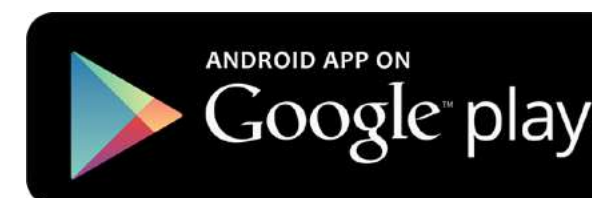

Desktop



For Windows environments, CudaLaunch is also available in a standalone version without requiring installation or local admin rights. This version is available via the [Barracuda Download Portal](#).



## Network Access Client

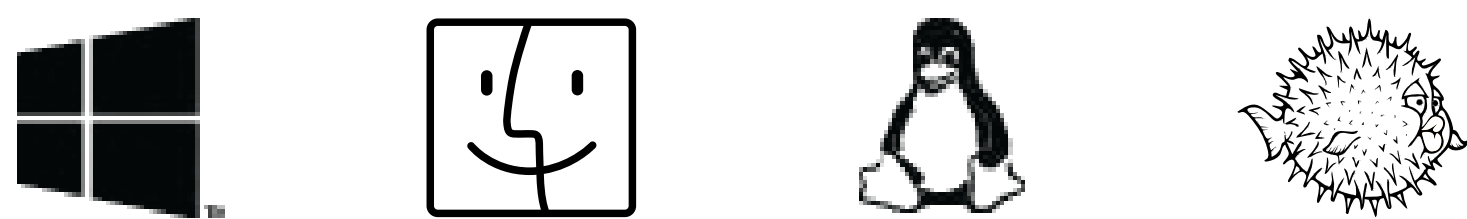

Every Barracuda CloudGen Firewall supports an unlimited number of remote access clients at no extra cost. The Barracuda Network Access Client provides a sophisticated VPN client for Windows, macOS, and Linux that provides richer performance and functionality than standard IPsec client software. Benefits include quick restoration of encrypted tunnels, “Always On” remote access connections for PCs, redundant gateway support, selective routing of network traffic through the encrypted tunnel, and optimal gateway detection based on location.

The Barracuda Network Access Client, when used with a Barracuda CloudGen Firewall, provides centrally managed Network Access Control (NAC) and an advanced Personal Firewall. This enforces client health and security policies for remote users connecting to the corporate network.

	FIREWALL BASE LICENCE	ADVANCED REMOTE ACCESS
One concurrent CudaLaunch session (for evaluation)	✓	✓
Multiple concurrent sessions by same user	-	✓
Multi-factor authentication (TOTP)	-	✓ (unlimited users per device)
Barracuda CloudGen Access Proxy service	✓	✓
<b>BARRACUDA NETWORK ACCESS CLIENT</b>		
TINA remote access client (Windows, macOS, Linux, and openBSD)	✓	✓
Personal firewall & health checks (Windows only)	-	✓
Microsoft Access Control Services support	✓	✓
Two-factor authentication (Windows and macOS) <sup>1</sup>	✓	✓
SAML authentication support	-	✓
<b>LIGHTWEIGHT BROWSER-BASED REMOTE ACCESS</b>		
TLS encrypted web portal (for desktop / mobile)	-	✓
Health checks	-	✓
Multi-factor authentication	-	✓
<b>CUDALAUNCH</b>		
TLS/SSL tunnels	-	✓
Native apps	-	✓
Dynamic apps	-	✓
Full remote access connections (iOS, Android, and Windows)	-	✓
Activation of dynamic firewall rules	-	✓
RDP launching (no Java)	-	✓
Multi-factor authentication	-	✓

<sup>1</sup> Requires external handling of additional authentication factors (e.g., Azure Multi-Factor Authentication).



# Once-only central management

To centralize management across many different firewalls and remote access users, the **Barracuda Firewall Control Center** enables administrators to manage and configure security, content, traffic management, and network access policies from a single interface. Template-based configuration and globally available security objects enable efficient configuration across thousands of locations.

The Firewall Control Center helps significantly reduce the cost associated with security management while providing extra functionality both centrally and locally at the managed gateway. Software patches and version upgrades are centrally controlled from within the management console and deployment can be applied to all managed devices.

Highly customizable administrative roles can be defined to delegate administrative capabilities for specific departments or locations.

## Lifecycle management

Scalable CloudGen Firewall deployments offer companies sustainable investment protection. Energize Updates automatically provide the latest firmware and threat definitions to keep the appliance up to date. With a active Instant Replacement subscription, organizations receive a new appliance with the latest specs every four years.

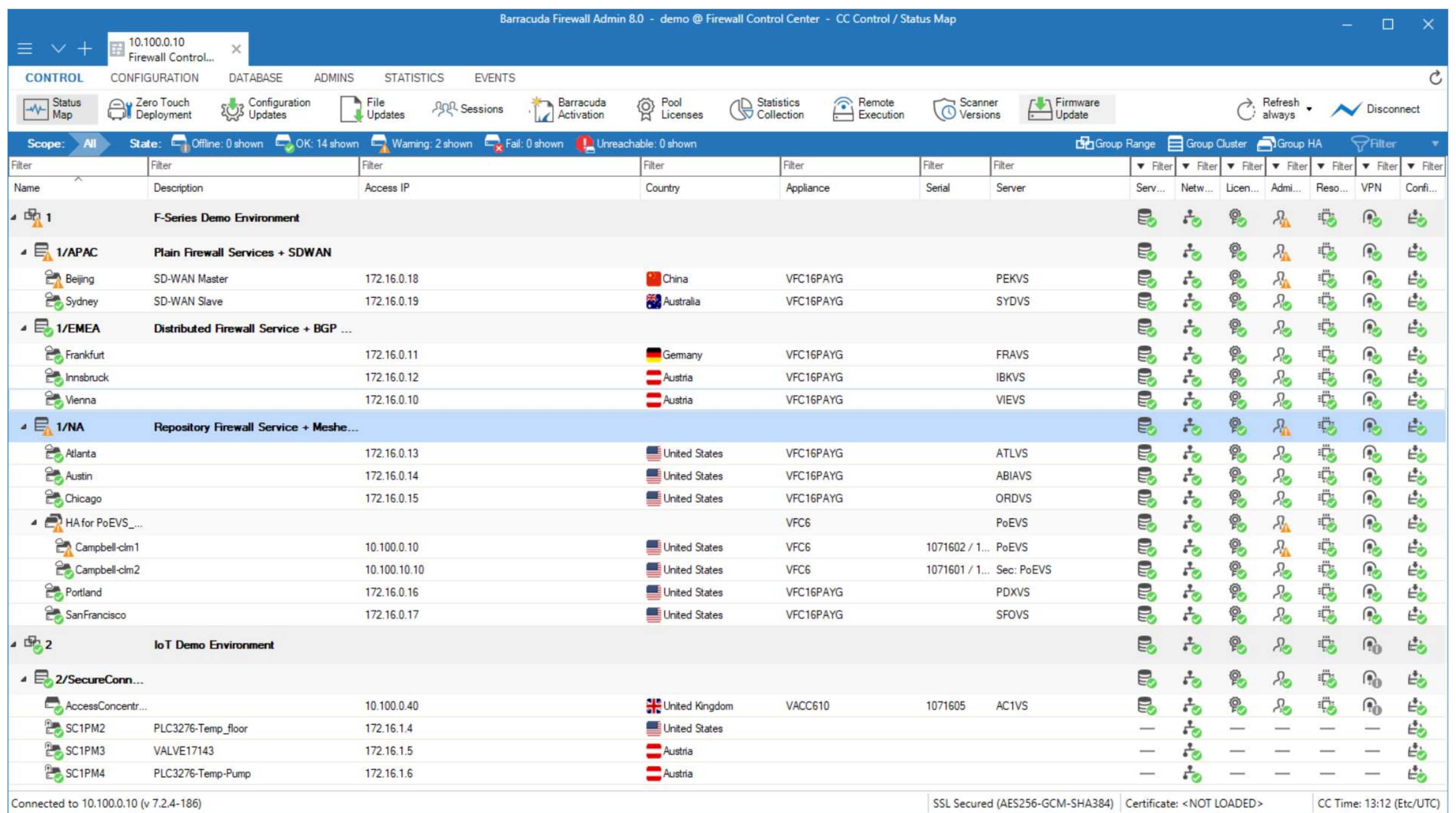

Figure 12 - Firewall Control Center's Status Map displays a drill down status overview of all centrally managed CloudGen Firewall deployments.



## Scalable deployment

Managing the security issues in a widely distributed enterprise network can be painful and extremely time consuming. Managing a system may take only 15 minutes per day. But having 20 firewall systems in place results in five hours per day – just to manage the existing system.

With Firewall Control Center, managing multiple CloudGen Firewall deployments takes the same amount of time as managing one. [For more details, please click here,](#)

## Cloud deployment

Moving infrastructure to the cloud does not stop at administration tools. Therefore, the Firewall Control Center is available for direct deployment in public cloud offerings like Microsoft Azure, Amazon Web Services, and Google Cloud Platform in a Bring-Your-Own-License model.

## Lifecycle automation

CloudGen Firewall features a full set of well-documented automation APIs. The automation APIs included with every CloudGen Firewall allow endusers as well as service partners to automate the management of their devices, across the complete lifecycle. This enables faster deployment, enhanced consistency in management and more rapid adoption of configuration changes for on-premises, virtual as well as cloud-hosted devices.

## Zero-touch deployment

Especially for large rollouts without having IT personnel on the ground at remote locations, CloudGen Firewall in conjunction with Firewall Control Center supports zero-touch deployment. This feature allows to send appliances to locations without having to pre-setup them beforehand.

After unpacking the appliance and powering it up, the appliance automatically connects to the Barracuda Cloud Control where it receives a very basic set of information. This information is just enough to create a high-secure connection (utilizing TINA protocol) to the private Firewall Control Center the appliance shall be assigned to.

The full configuration is sent to the appliance via an encrypted connection and the appliance becomes part of the security infrastructure without the need of dedicated and trained IT security administrators at the location.

## Enterprise- and service provider licensing

The Firewall Control Center lets you centrally manage all CloudGen Firewall licensing flexible and interdependently of hardware. You can make best use of type of licensing for CloudGen Firewall deployments when you have a large number of firewalls running across a wide geographic area.

For more information on this type of licensing, please see the dedicated whitepaper “[Enterprise and Service-Provider Licensing](#)” available on [barracuda.com](http://barracuda.com).



## Comparison of Barracuda Firewall Control Center models

FEATURES	VC400 VIRTUAL ENVIRONMENT	VCC400 PUBLIC CLOUD	VC610 VIRTUAL ENVIRONMENT	VCC610 PUBLIC CLOUD	VC820 VIRTUAL ENVIRONMENT
Max. no. of managed gateways [Recommended <sup>1</sup> ]	unlimited [up to 50]	unlimited [up to 50]	unlimited [up to 1,000]	unlimited [up to 1,000]	unlimited [up to 3,000]
Manageable configuration groupings	1	1	Unlimited	Unlimited	Unlimited
Multi-administrator support	✓	✓	✓	✓	✓
Role-based administration	✓	✓	✓	✓	✓
Revision control system	✓	✓	✓	✓	✓
Central statistics	✓	✓	✓	✓	✓
Central syslog host / relay	✓	✓	✓	✓	✓
Firewall audit information collector / viewer	✓	✓	✓	✓	✓
Barracuda access monitor	✓	✓	✓	✓	✓
Barracuda Earth	-	-	-	-	-
PKI service	-	-	✓	✓	✓
High availability	Optional	Optional	Optional	Optional	HA license included
Multi-tenancy	-	-	Yes (via configuration groupings)		Yes (5 tenants)
Additional tenant for multi-tenancy	-	-	-	-	Optional

<sup>1</sup> Depending on range of functions, setup, and Vx hardware



# Analytics and reporting

## Information is key

Staying secure and seamlessly connected requires you to have up-to-date data to be able to continuously assess the effectiveness of your security measures and WAN performance. The vast amount of data coming from different origins and in different formats often needs manual processing, an approach that is both error prone and costly. If information retrieval and processing of raw data is not automated, auditing and reporting requirements will represent an enormous yet inevitable burden. **Barracuda Firewall Insights** automates these challenging tasks.

## Central reporting instance

Firewall Insights is an advanced reporting and analysis solution that gathers, consolidates, and analyzes data fully automatically from any CloudGen Firewall deployed across your organizational network, including public cloud deployments. Barracuda's reporting solution provides status overviews for the entire WAN, including details and availability information on SD-WAN connections, transport details, security, and web- and network-traffic details. More than one hundred predefined reports, including summary reports, are available for areas like safety and liability, network activity, web activity, security, and productivity.

All reports are customizable for individual timeframes and can include all or just a subset of the deployed firewalls. This enables businesses to provide policy-compliant access to information to all management levels within a secure and trusted environment.

For availability and hardware requirements, please see “Available subscriptions” on page 87.

## Central log aggregator

Firewall Insights works as the central log aggregator for every CloudGen Firewall. Since installation on virtualization solutions supports an almost unlimited amount of storage, the log retention period is flexible, depending on the demands or local regulation authority.

## Advanced definition, automatic generation, and reliable delivery

Creating reports that visualize how the CloudGen Firewall protects and connects your networks has never been easier. The graphical user interface lets you quickly select from hundreds of predefined reporting options. Various output formats for paper or web-based publishing ensure that the most accurate and reliable information is available for your strategic business decisions.

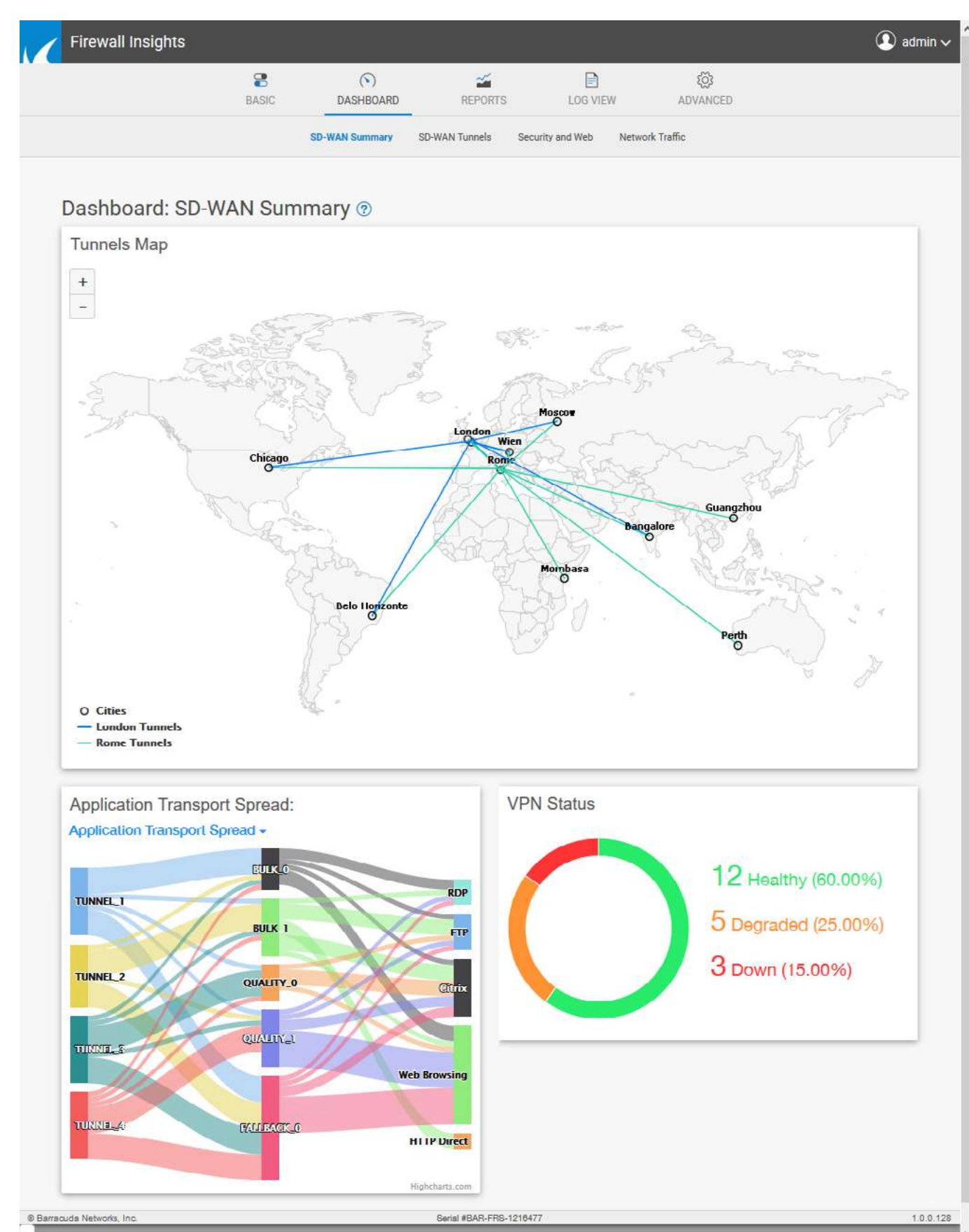

Figure 13 - Barracuda Firewall Insights' dashboard



# Hardware facts

## Model comparison

With hardware models available for small branch offices as well as large headquarters and datacenters, a corresponding offering of [virtual appliances](#), and a comprehensive [public cloud support](#), the Barracuda CloudGen Firewall is designed for deployment across the entire enterprise.

For more information on how Barracuda can secure your Internet-of-Things deployments, please consult the solution overview [Barracuda Industrial Security](#) (also available in [German](#)).

MODEL COMPARISON	ENTRY LEVEL/ BRANCH OFFICES					MID-RANGE			HIGH-END			DIN RAIL / RUGGED				
	F12A	F18B	F80B	F180B	F280C	F380B	F400C	F600D	F800C	F900B	F1000B	F93A.R	F193A.R	SC2X	SC3X	
<b>PERFORMANCE <sup>[1]</sup></b>	(MORE DETAILED ON <a href="#">PAGE 26 FF.</a> )					<a href="#">PAGE 31 FF.</a>			<a href="#">PAGE 39 FF.</a>			<a href="#">PAGE 50 FF.</a>				
Firewall throughput	1.2 Gbps	2.0 Gbps	2.0 Gbps	3.2 Gbps	4.8 Gbps	8.5 Gbps	13 Gbps	20 Gbps	30 Gbps	45 Gbps	52 Gbps	1.5 Gbps	2.1 Gbps	–	–	
SD-WAN throughput	220 Mbps	720 Mbps	720 Mbps	800 Mbps	1.5 Gbps	2.1 Gbps	3.6 Gbps	6.8 Gbps	7.5 Gbps	13.5 Gbps	15.8 Gbps	240 Mbps	320 Mbps	30 Mbps	30 Mbps	
IPS throughput	400 Mbps	600 Mbps	600 Mbps	1.0 Gbps	2.0 Gbps	2.5 Gbps	4.2 Gbps	8.0 Gbps	8.3 Gbps	13 Gbps	16 Gbps	400 Mbps	790 Mbps	–	–	
NGFW throughput	250 Mbps	400 Mbps	400 Mbps	1.2 Gbps	1.6 Gbps	2.0 Gbps	3.7 Gbps	6.4 Gbps	7.7 Gbps	12 Gbps	14.8 Gbps	400 Mbps	800 Mbps	–	–	
Threat protection throughput	230 Mbps	380 Mbps	380 Mbps	1.0 Gbps	1.5 Gbps	1.7 Gbps	3.1 Gbps	5.8 Gbps	7.6 Gbps	11.5 Gbps	13.5 Gbps	380 Mbps	700 Mbps	–	–	
Concurrent sessions	80,000	80,000	80,000	150,000	300,000	400,000	500,000	2,100,000	2,500,000	4,000,000	10,000,000	80,000	100,000	–	–	
New sessions/s	8,000	12,000	12,000	12,000	12,000	15,000	20,000	115,000	180,000	190,000	250,000	8,000	9,000	–	–	
Recommended concurrent users (depending on feature set)	5-75	50-100	50-100	75-150	150-300	200-500	300-1,000	1,000-4,000	4,000-6,000	7,000-15,000	7,000-15,000	50-100	75-150	–	–	
Integrated WiFi access point	–	–	✓	✓	✓	–	–	–	–	–	–	–	–	✓ <sup>[3]</sup>	✓ <sup>[3]</sup>	
SD-WAN connections	Unlimited															
Recommended no. of remote access clients	10	25	25	50	75	100	250	500	1,000	2,000	3,000	50	75	–	–	
Rugged hardware	–	–	–	–	–	–	–	–	–	–	–	✓	✓	–	✓	
<b>AVAILABLE SOFTWARE/FEATURE SUBSCRIPTIONS (EXCERPT, MORE DETAILED ON <a href="#">PAGE 87 FF.</a>)</b>																
Energize Updates	<b>MANDATORY</b>															
Firewall Insights	<b>OPTIONAL</b>													–	–	
Advanced Threat Protection	<b>OPTIONAL</b>													–	–	
Malware Protection	<b>OPTIONAL <sup>[2]</sup></b>													–	–	
Advanced Remote Access	–	<b>OPTIONAL</b>													–	–
<b>AVAILABLE HARDWARE/SUPPORT SUBSCRIPTIONS (EXCERPT, MORE DETAILED ON <a href="#">PAGE 87 FF.</a>)</b>																
Warranty Extension	<b>OPTIONAL</b>															
Instant Replacement	<b>OPTIONAL</b>															
Premium Support	on request							<b>OPTIONAL</b>					on request			

1 Numbers are "up to"; for detailed information on throughput and how throughput numbers are measured, please refer to the hardware specifications on [page 26 ff.](#)

2 F12A features cloud-based malware protection as part of an active Advanced Threat Protection subscription.

3 Depends on selected sub-model.



SPECIFICATIONS - ENTRY AND BRANCH OFFICE MODELS

# CloudGen Firewall F12A

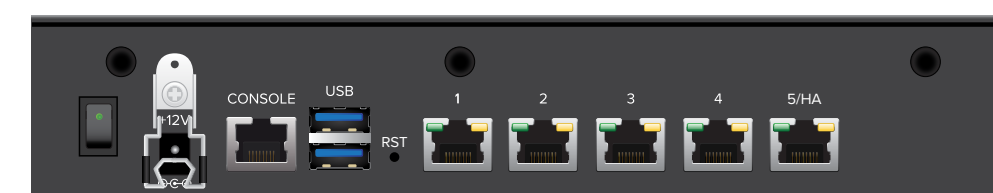

INTERFACES	
Copper ethernet NICs (1 GbE)	5x
USB 3.0	2x
VGA	-
Serial / console	1x RJ45
PERFORMANCE [AS OF FIRMWARE RELEASE 8.3.X]	
Firewall throughput [Gbps] <sup>[a]</sup>	1.2
SD-WAN throughput [AES-128, TINA std hash, Mbps] <sup>[b]</sup>	220
SD-WAN throughput [AES-256, TINA std hash, Mbps] <sup>[b]</sup>	200
SD-WAN throughput [AES-256, SHA256, Mbps] <sup>[b]</sup>	170
SD-WAN throughput [AES-256, MD5, Mbps] <sup>[b]</sup>	200
SD-WAN throughput [AES-256, GCM, Mbps] <sup>[b]</sup>	170
IPS throughput [Mbps] <sup>[c]</sup>	400
NGFW throughput [Mbps] <sup>[d]</sup>	250
Threat protection throughput [Mbps] <sup>[e]</sup>	230
Concurrent sessions	80,000
New sessions/s	8,000
Recommended number of concurrent users <sup>[f]</sup>	5-75
MEMORY	
RAM [GB]	2
MASS STORAGE	
Type	SSD
Size [(GB) or better]	80
SSD MTBF [hours]	n/a
SIZE, WEIGHT, DIMENSIONS	
Weight appliance [lbs] / [kg]	4.4 / 2.0
Appliance size: width x depth x height [in]	9.1 x 6.0 x 1.7
Appliance size: width x depth x height [mm]	232 x 153 x 44
Weight carton with appliance [lbs] / [kg]	5.2 / 2.4
Carton size: width x depth x height [in]	12.2 x 10.2 x 7.1
Carton size: width x depth x height [mm]	310 x 260 x 180
Form factor	Compact
HARDWARE	
Display	-
Cooling	Fanless
ENVIRONMENTAL	
Noise emission [db/A]	n/a
Operating temperature [°F] / [°C]	+30 to +105 / 0 to +40
Storage temperature [°F] / [°C]	-5 to +160 / -20 to +70
Operating humidity (non-condensing)	5% to 95%

MTBF [SYSTEM]	
MTBF [yrs.] <sup>[g]</sup>	> 5
POWER AND EFFICIENCY	
Power supply	Single
Power supply type	External power brick
Power type [AC/DC]	AC
Input ratings [Volts]	100-240
Input frequency [Hz]	50-60
Auto sense	✓
Max. power draw [W]	45
Max. power draw @ 120V [Amps]	0.4
Max. power draw @ 230V [Amps]	0.2
Max. heat dissipation [W]	19
Max. heat dissipation [BTU]	65
Energy efficiency (average)	> 85%
CERTIFICATIONS AND COMPLIANCE (ALSO SEE PAGE 104 FF)	
CE emissions	✓
CE electrical safety	✓
FCC emissions	✓
ROHS compliant	✓
PACKAGING CONTENT	
Appliance	✓
Straight network cable	✓
External power brick and cables	✓
USB flash drive for recovery and installation	✓
Quick start guide	✓

All performance values are measured under optimized conditions and are to be considered as „up to“ values and may vary depending on system configuration and infrastructure:

- a Firewall throughput measured with large UDP packets (MTU1500), bi-directional across multiple ports.
- b SD-WAN throughput is based on 1415 Byte UDP packets, bidirectional using BreakingPoint traffic generator.
- c IPS throughput is measured with large UDP packets (MTU1500) and across multiple ports.
- d NGFW throughput is measured with IPS, application control, and web filter enabled, based on BreakingPoint Realworld-IPS-Enterprise-Traffic-Mix, bidirectional across multiple ports.
- e Threat protection throughput is measured with IPS, application control, web filter, and cloud-based antivirus and SSL inspection enabled (as part of an active Advanced Threat Protection subscription), based on BreakingPoint Realworld-IPS-Enterprise-Traffic-Mix, bidirectional across multiple ports.
- f Depending on feature set; for more detailed information on sizing, please use the free sizing calculator on [Barracuda Campus](#).
- g MTBF according to common usage. High load on SSD and extreme environmental conditions might reduce MTBF.

Errors and omissions excepted. Specifications subject to change without notice.



# CloudGen Firewall F18B

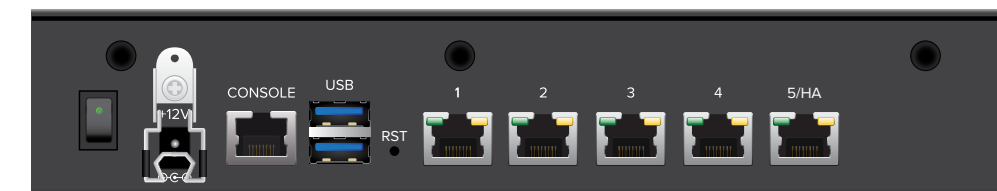

INTERFACES	
Copper ethernet NICs (1 GbE)	5x
USB 3.0	2x
Serial / console	1x RJ45
Integrated WiFi (IEEE 802.11b/g/n)	-
PERFORMANCE [AS OF FIRMWARE RELEASE 8.3.X]	
Firewall throughput [Gbps] <sup>[a]</sup>	2.0
SD-WAN throughput [AES-128, TINA std hash, Mbps] <sup>[b]</sup>	720
SD-WAN throughput [AES-256, TINA std hash, Mbps] <sup>[b]</sup>	660
SD-WAN throughput [AES-256, SHA256, Mbps] <sup>[b]</sup>	270
SD-WAN throughput [AES-256, MD5, Mbps] <sup>[b]</sup>	570
SD-WAN throughput [AES-256, GCM, Mbps] <sup>[b]</sup>	310
IPS throughput [Mbps] <sup>[c]</sup>	600
NGFW throughput [Mbps] <sup>[d]</sup>	400
Threat protection throughput [Mbps] <sup>[e]</sup>	380
Concurrent sessions	80,000
New sessions/s	12,000
Recommended number of concurrent users <sup>[f]</sup>	50-100
MEMORY	
RAM [GB]	4 or higher
MASS STORAGE	
Type	SSD
Size [(GB) or better]	80
SSD MTBF [hours]	1,200,000
SIZE, WEIGHT, DIMENSIONS	
Weight appliance [lbs] / [kg]	4.4 / 2.0
Appliance size: width x depth x height [in]	9.1 x 6.0 x 1.7
Appliance size: width x depth x height [mm]	232 x 153 x 44
Weight carton with appliance [lbs] / [kg]	7.7 / 3.5
Carton size: width x depth x height [in]	12.2 x 10.2 x 7.1
Carton size: width x depth x height [mm]	310 x 260 x 180
Form factor	Desktop
HARDWARE	
Display	-
Cooling	Fanless
ENVIRONMENTAL	
Noise emission [db/A]	n/a
Operating temperature [°F] / [°C]	+30 to +105 / 0 to +40
Storage temperature [°F] / [°C]	-5 to +160 / -20 to +70
Operating humidity (non-condensing)	5% to 95%

MTBF [SYSTEM]	
MTBF [yrs.] <sup>[g]</sup>	> 5
POWER AND EFFICIENCY	
Power supply	Single, 12V
Power supply type	External power brick
Power type [AC/DC]	DC
Input ratings [Volts]	100-240
Input frequency [Hz]	50-60
Auto sense	✓
Max. power draw [W]	45
Max. power draw @ 120V [Amps]	0.4
Max. power draw @ 230V [Amps]	0.2
Max. heat dissipation [W]	26.7
Max. heat dissipation [BTU]	90.9
Energy efficiency (average)	> 93%
CERTIFICATIONS AND COMPLIANCE (ALSO SEE PAGE 104 FF)	
CE emissions	✓
CE electrical safety	✓
FCC emissions	✓
ROHS compliant	✓
PACKAGING CONTENT	
Appliance	✓
Straight network cable	✓
External power brick and cables	✓
USB flash drive for recovery and installation	✓
Quick start guide	✓

All performance values are measured under optimized conditions and are to be considered as „up to“ values and may vary depending on system configuration and infrastructure:

- a Firewall throughput measured with large UDP packets (MTU1500), bi-directional across multiple ports.
- b SD-WAN throughput is based on 1415 Byte UDP packets, bidirectional using BreakingPoint traffic generator.
- c IPS throughput is measured with large UDP packets (MTU1500) and across multiple ports.
- d NGFW throughput is measured with IPS, application control, and web filter enabled, based on BreakingPoint Realworld-IPS-Enterprise-Traffic-Mix, bidirectional across multiple ports.
- e Threat protection throughput is measured with IPS, application control, web filter, and cloud-based antivirus and SSL inspection enabled (as part of an active Advanced Threat Protection subscription), based on BreakingPoint Realworld-IPS-Enterprise-Traffic-Mix, bidirectional across multiple ports.
- f Depending on feature set; for more detailed information on sizing, please use the free sizing calculator on [Barracuda Campus](#).
- g MTBF according to common usage. High load on SSD and extreme environmental conditions might reduce MTBF.

Errors and omissions excepted. Specifications subject to change without notice.



# CloudGen Firewall F80B

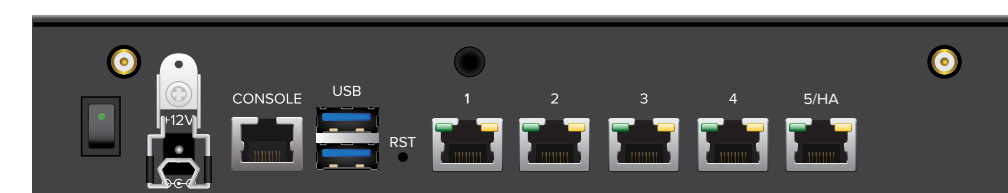

INTERFACES	
Copper ethernet NICs (1 GbE)	5x
USB 3.0	2x
Serial / console	1x RJ45
Integrated WiFi (IEEE 802.11b/g/n)	✓
PERFORMANCE [AS OF FIRMWARE RELEASE 8.3.X]	
Firewall throughput [Gbps] <sup>[a]</sup>	2.0
SD-WAN throughput [AES-128, TINA std hash, Mbps] <sup>[b]</sup>	720
SD-WAN throughput [AES-256, TINA std hash, Mbps] <sup>[b]</sup>	660
SD-WAN throughput [AES-256, SHA256, Mbps] <sup>[b]</sup>	270
SD-WAN throughput [AES-256, MD5, Mbps] <sup>[b]</sup>	570
SD-WAN throughput [AES-256, GCM, Mbps] <sup>[b]</sup>	310
IPS throughput [Mbps] <sup>[c]</sup>	600
NGFW throughput [Mbps] <sup>[d]</sup>	400
Threat protection throughput [Mbps] <sup>[e]</sup>	380
Concurrent sessions	80,000
New sessions/s	12,000
Recommended number of concurrent users <sup>[f]</sup>	50-100
MEMORY	
RAM [GB]	4 or higher
MASS STORAGE	
Type	SSD
Size [(GB) or better]	80
SSD MTBF [hours]	1,200,000
SIZE, WEIGHT, DIMENSIONS	
Weight appliance [lbs] / [kg]	4.4 / 2.0
Appliance size: width x depth x height [in]	9.1 x 6.0 x 1.7
Appliance size: width x depth x height [mm]	232 x 153 x 44
Weight carton with appliance [lbs] / [kg]	7.7 / 3.5
Carton size: width x depth x height [in]	12.2 x 10.2 x 7.1
Carton size: width x depth x height [mm]	310 x 260 x 180
Form factor	Desktop
HARDWARE	
Hardware crypto accelerator	Yes, built-in
Cooling	Fanless
ENVIRONMENTAL	
Noise emission [db/A]	n/a
Operating temperature [°F] / [°C]	+30 to +105 / 0 to +40
Storage temperature [°F] / [°C]	-5 to +160 / -20 to +70
Operating humidity (non-condensing)	5% to 95%

MTBF [SYSTEM]	
MTBF [yrs.] <sup>[g]</sup>	> 5
POWER AND EFFICIENCY	
Power supply	Single, 12V
Power supply type	External power brick
Power type [AC/DC]	DC
Input ratings [Volts]	100-240
Input frequency [Hz]	50-60
Auto sense	✓
Max. power draw [W]	45
Max. power draw @ 120V [Amps]	0.4
Max. power draw @ 230V [Amps]	0.2
Max. heat dissipation [W]	26.7
Max. heat dissipation [BTU]	90.9
Energy efficiency (average)	> 93%
CERTIFICATIONS AND COMPLIANCE (ALSO SEE PAGE 104 FF)	
CE emissions	✓
CE electrical safety	✓
FCC emissions	✓
ROHS compliant	✓
PACKAGING CONTENT	
Appliance	✓
Straight network cable	✓
External power brick and cables	✓
USB flash drive for recovery and installation	✓
Quick start guide	✓
2x Wireless antenna	✓

All performance values are measured under optimized conditions and are to be considered as „up to“ values and may vary depending on system configuration and infrastructure:

- a Firewall throughput measured with large UDP packets (MTU1500), bi-directional across multiple ports.
- b SD-WAN throughput is based on 1415 Byte UDP packets, bidirectional using BreakingPoint traffic generator.
- c IPS throughput is measured with large UDP packets (MTU1500) and across multiple ports.
- d NGFW throughput is measured with IPS, application control, and web filter enabled, based on BreakingPoint Realworld-IPS-Enterprise-Traffic-Mix, bidirectional across multiple ports.
- e Threat protection throughput is measured with IPS, application control, web filter, and cloud-based antivirus and SSL inspection enabled (as part of an active Advanced Threat Protection subscription), based on BreakingPoint Realworld-IPS-Enterprise-Traffic-Mix, bidirectional across multiple ports.
- f Depending on feature set; for more detailed information on sizing, please use the free sizing calculator on [Barracuda Campus](#).
- g MTBF according to common usage. High load on SSD and extreme environmental conditions might reduce MTBF.

Errors and omissions excepted. Specifications subject to change without notice.



# CloudGen Firewall F180B

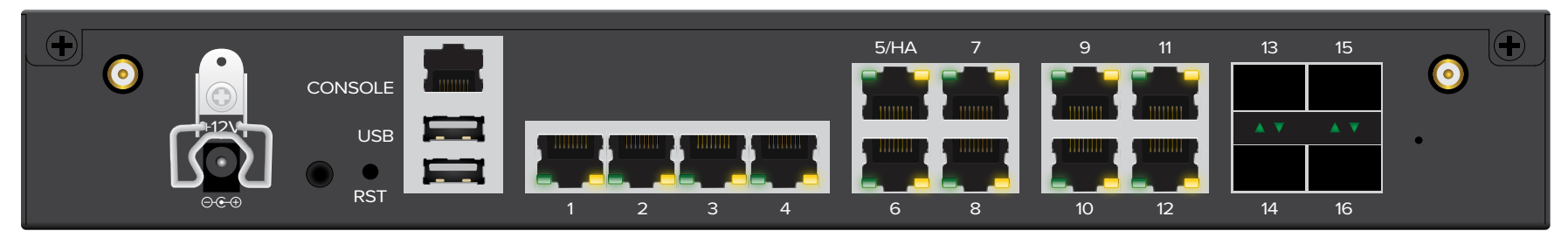

INTERFACES	
Copper ethernet NICs (1 GbE)	12x
SFP fiber NICs (1 GbE)	4x
USB 3.0	2x
Serial / console	1x RJ45
Integrated WiFi (IEEE 802.11b/g/n)	✓
PERFORMANCE [AS OF FIRMWARE RELEASE 8.3.X]	
Firewall throughput [Gbps] <sup>[a]</sup>	3.2
SD-WAN throughput [AES-128, TINA std hash, Mbps] <sup>[b]</sup>	800
SD-WAN throughput [AES-256, TINA std hash, Mbps] <sup>[b]</sup>	730
SD-WAN throughput [AES-256, SHA256, Mbps] <sup>[b]</sup>	300
SD-WAN throughput [AES-256, MD5, Mbps] <sup>[b]</sup>	650
SD-WAN throughput [AES-256, GCM, Mbps] <sup>[b]</sup>	350
IPS throughput [Gbps] <sup>[c]</sup>	1.0
NGFW throughput [Gbps] <sup>[d]</sup>	1.2
Threat protection throughput [Gbps] <sup>[e]</sup>	1.0
Concurrent sessions	150,000
New sessions/s	12,000
Recommended number of concurrent users <sup>[f]</sup>	75-150
MEMORY	
RAM [GB]	4 or higher
MASS STORAGE	
Type	SSD
Size [(GB) or better]	100
SSD MTBF [hours]	1,200,000
SIZE, WEIGHT, DIMENSIONS	
Weight appliance [lbs] / [kg]	5.1 / 2.3
Appliance size: width x depth x height [in]	11.8 x 8.6 x 1.7
Appliance size: width x depth x height [mm]	300 x 219 x 44
Weight carton with appliance [lbs] / [kg]	10.1 / 4.6
Carton size: width x depth x height [in]	15.7 x 13.4 x 7.3
Carton size: width x depth x height [mm]	400 x 340 x 185
Form factor	Desktop
HARDWARE	
Display	-
Cooling	Fan
ENVIRONMENTAL	
Noise emission [db/A]	< 40
Operating temperature [°F] / [°C]	+30 to +95 / 0 to +40
Storage temperature [°F] / [°C]	-5 to +160 / -20 to +70
Operating humidity (non-condensing)	5% to 95%

MTBF [SYSTEM]	
MTBF [yrs.] <sup>[g]</sup>	> 5
POWER AND EFFICIENCY	
Power supply	Single
Power supply type	External power brick
Power type [AC/DC]	AC
Input ratings [Volts]	90-264
Input frequency [Hz]	50-60
Auto sense	n/a
Max. power draw [W]	90
Max. power draw @ 120V [Amps]	4
Max. power draw @ 230V [Amps]	2
Max. heat dissipation [W]	52
Max. heat dissipation [BTU]	180
Energy efficiency (average)	> 89%
CERTIFICATIONS AND COMPLIANCE (ALSO SEE PAGE 104 FF)	
CE emissions	✓
CE electrical safety	✓
FCC emissions	✓
ROHS compliant	✓
PACKAGING CONTENT	
Appliance	✓
Straight network cable	✓
External power brick and cables	✓
USB flash drive for recovery and installation	✓
Quick start guide	✓
2x Wireless antenna	✓
2x Barracuda L-shape rack mount bracket	✓

All performance values are measured under optimized conditions and are to be considered as „up to“ values and may vary depending on system configuration and infrastructure:

- a Firewall throughput measured with large UDP packets (MTU1500), bi-directional across multiple ports.
- b SD-WAN throughput is based on 1415 Byte UDP packets, bidirectional using BreakingPoint traffic generator.
- c IPS throughput is measured with large UDP packets (MTU1500) and across multiple ports.
- d NGFW throughput is measured with IPS, application control, and web filter enabled, based on BreakingPoint Realworld-IPS-Enterprise-Traffic-Mix, bidirectional across multiple ports.
- e Threat protection throughput is measured with IPS, application control, web filter, and cloud-based antivirus and SSL inspection enabled (as part of an active Advanced Threat Protection subscription), based on BreakingPoint Realworld-IPS-Enterprise-Traffic-Mix, bidirectional across multiple ports.
- f Depending on feature set; for more detailed information on sizing, please use the free sizing calculator on [Barracuda Campus](#).
- g MTBF according to common usage. High load on SSD and extreme environmental conditions might reduce MTBF.

Errors and omissions excepted. Specifications subject to change without notice.



# CloudGen Firewall F280C

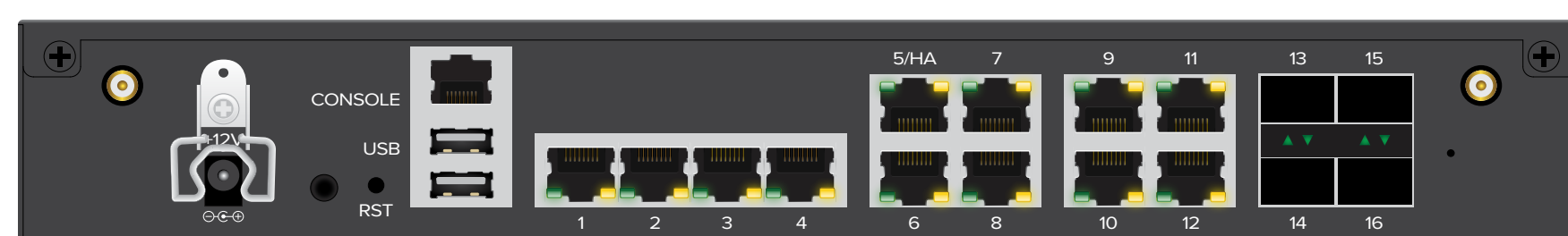

INTERFACES	
Copper ethernet NICs (1 GbE)	12x
SFP fiber NICs (1 GbE)	4x
USB 3.0	2x
Serial / console	1x RJ45
Integrated WiFi (IEEE 802.11b/g/n)	✓
PERFORMANCE [AS OF FIRMWARE RELEASE 8.3.X]	
Firewall throughput [Gbps] <sup>[a]</sup>	4.8
SD-WAN throughput [AES-128, TINA std hash, Gbps] <sup>[b]</sup>	1.5
SD-WAN throughput [AES-256, TINA std hash, Gbps] <sup>[b]</sup>	1.1
SD-WAN throughput [AES-256, SHA256, Mbps] <sup>[b]</sup>	600
SD-WAN throughput [AES-256, MD5, Gbps] <sup>[b]</sup>	800
SD-WAN throughput [AES-256, GCM, Mbps] <sup>[b]</sup>	750
IPS throughput [Gbps] <sup>[c]</sup>	2.0
NGFW throughput [Gbps] <sup>[d]</sup>	1.6
Threat protection throughput [Gbps] <sup>[e]</sup>	1.5
Concurrent sessions	300,000
New sessions/s	12,000
Recommended number of concurrent users <sup>[f]</sup>	150-300
MEMORY	
RAM [GB]	4
MASS STORAGE	
Type	SSD
Size [(GB) or better]	100
SSD MTBF [hours]	1,200,000
SIZE, WEIGHT, DIMENSIONS	
Weight appliance [lbs] / [kg]	5.1 / 2.3
Appliance size: width x depth x height [in]	11.8 x 8.6 x 1.7
Appliance size: width x depth x height [mm]	300 x 219 x 44
Weight carton with appliance [lbs] / [kg]	10.1 / 4.6
Carton size: width x depth x height [in]	15.7 x 13.4 x 7.3
Carton size: width x depth x height [mm]	400 x 340 x 185
Form factor	Desktop
HARDWARE	
Display	-
Cooling	Fan
ENVIRONMENTAL	
Noise emission [db/A]	< 40
Operating temperature [°F] / [°C]	+30 to +95 / 0 to +40
Storage temperature [°F] / [°C]	-5 to +160 / -20 to +70
Operating humidity (non-condensing)	10% to 95%

MTBF [SYSTEM]	
MTBF [yrs.] <sup>[g]</sup>	> 5
POWER AND EFFICIENCY	
Power supply	Single
Power supply type	External power brick
Power type [AC/DC]	AC
Input ratings [Volts]	90-264
Input frequency [Hz]	50-60
Auto sense	n/a
Max. power draw [W]	90
Max. power draw @ 120V [Amps]	4
Max. power draw @ 230V [Amps]	2
Max. heat dissipation [W]	52
Max. heat dissipation [BTU]	180
Energy efficiency (average)	> 89%
CERTIFICATIONS AND COMPLIANCE (ALSO SEE PAGE 104 FF)	
CE emissions	✓
CE electrical safety	✓
FCC emissions	✓
ROHS compliant	✓
PACKAGING CONTENT	
Appliance	✓
Straight network cable	✓
External power brick and cables	✓
USB flash drive for recovery and installation	✓
Quick start guide	✓
2x Wireless antenna	✓
2x Barracuda L-shape rack mount bracket	✓

All performance values are measured under optimized conditions and are to be considered as „up to“ values and may vary depending on system configuration and infrastructure:

- a Firewall throughput measured with large UDP packets (MTU1500), bi-directional across multiple ports.
- b SD-WAN throughput is based on 1415 Byte UDP packets, bidirectional using BreakingPoint traffic generator.
- c IPS throughput is measured with large UDP packets (MTU1500) and across multiple ports.
- d NGFW throughput is measured with IPS, application control, and web filter enabled, based on BreakingPoint Realworld-IPS-Enterprise-Traffic-Mix, bidirectional across multiple ports.
- e Threat protection throughput is measured with IPS, application control, web filter, and cloud-based antivirus and SSL inspection enabled (as part of an active Advanced Threat Protection subscription), based on BreakingPoint Realworld-IPS-Enterprise-Traffic-Mix, bidirectional across multiple ports.
- f Depending on feature set; for more detailed information on sizing, please use the free sizing calculator on [Barracuda Campus](#).
- g MTBF according to common usage. High load on SSD and extreme environmental conditions might reduce MTBF.

Errors and omissions excepted. Specifications subject to change without notice.



SPECIFICATIONS - MID-RANGE MODELS

# CloudGen Firewall F380B

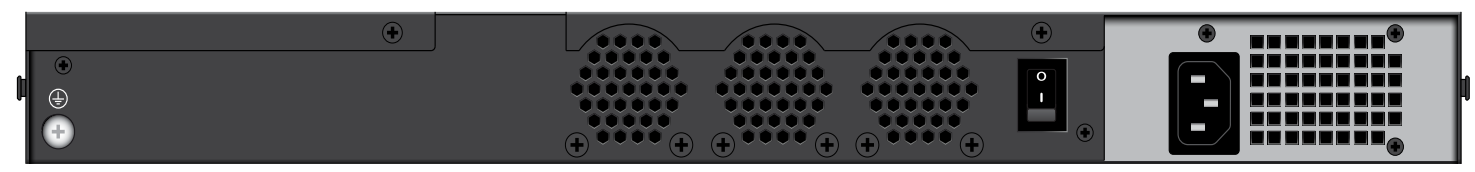
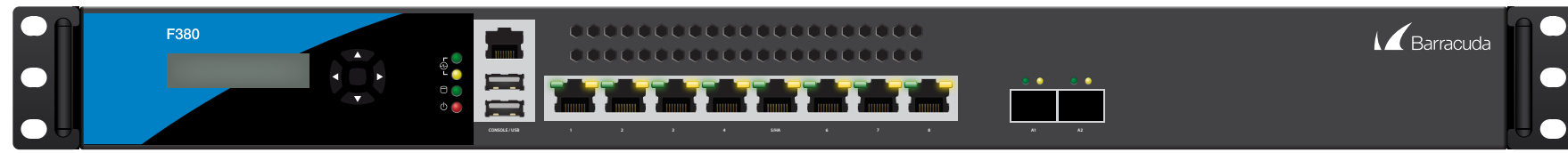

INTERFACES	
Copper ethernet NICs (1 GbE)	8x
SFP+ fiber NICs (10 GbE)	2x
USB 3.0	2x
Serial / console	1x RJ45
PERFORMANCE [AS OF FIRMWARE RELEASE 8.3.X]	
Firewall throughput [Gbps] <sup>[a]</sup>	8.5
SD-WAN throughput [AES-128, TINA std hash, Gbps] <sup>[b]</sup>	2.1
SD-WAN throughput [AES-256, TINA std hash, Gbps] <sup>[b]</sup>	1.2
SD-WAN throughput [AES-256, SHA256, Mbps] <sup>[b]</sup>	700
SD-WAN throughput [AES-256, MD5, Gbps] <sup>[b]</sup>	1.5
SD-WAN throughput [AES-256, GCM, Mbps] <sup>[b]</sup>	900
IPS throughput [Gbps] <sup>[c]</sup>	2.5
NGFW throughput [Gbps] <sup>[d]</sup>	2.0
Threat protection throughput [Gbps] <sup>[e]</sup>	1.7
Concurrent sessions	400,000
New sessions/s	15,000
Recommended number of concurrent users <sup>[f]</sup>	200-500
MEMORY	
RAM [GB]	4
MASS STORAGE	
Type	SSD
Size [(GB) or better]	120
SSD MTBF [hours]	1,200,000
SIZE, WEIGHT, DIMENSIONS	
Weight appliance [lbs] / [kg]	18.5 / 8.4
Appliance size: width x depth x height [in]	17.3 x 17.3 x 1.7
Appliance size: width x depth x height [mm]	440 x 440 x 44
Weight carton with appliance [lbs] / [kg]	20.7 / 9.4
Carton size: width x depth x height [in]	29.7 x 21.85 x 8
Carton size: width x depth x height [mm]	755 x 555 x 203
Form factor	1U rack mount
HARDWARE	
Display	✓
Cooling	Fan
ENVIRONMENTAL	
Noise emission [db/A]	n/a
Operating temperature [°F] / [°C]	+33 to +104 / 0 to +40
Storage temperature [°F] / [°C]	-5 to +160 / -20 to +70
Operating humidity (non-condensing)	10% to 85%

MTBF [SYSTEM]	
MTBF [yrs.] <sup>[g]</sup>	> 5
POWER AND EFFICIENCY	
Power supply	Single
Power supply type	Internal
Power type [AC/DC]	AC
Input ratings [Volts]	100-240
Input frequency [Hz]	50-60
Auto sense	✓
Max. power draw [W]	174
Max. power draw @ 120V [Amps]	12
Max. power draw @ 230V [Amps]	6
Max. heat dissipation [W]	23
Max. heat dissipation [BTU]	77
Energy efficiency (average)	> 87%
CERTIFICATIONS AND COMPLIANCE (ALSO SEE PAGE 104 FF)	
CE emissions	✓
CE electrical safety	✓
FCC emissions	✓
ROHS compliant	✓
PACKAGING CONTENT	
Appliance	✓
Straight network cable	✓
Direct power-to-wall outlet	✓
USB flash drive for recovery and installation	✓
Quick start guide	✓
2x Barracuda L-shape rack mount bracket	✓
Barracuda rail kit	Optional

All performance values are measured under optimized conditions and are to be considered as „up to“ values and may vary depending on system configuration and infrastructure:

- a Firewall throughput measured with large UDP packets (MTU1500), bi-directional across multiple ports.
- b SD-WAN throughput is based on 1415 Byte UDP packets, bidirectional using BreakingPoint traffic generator.
- c IPS throughput is measured with large UDP packets (MTU1500) and across multiple ports.
- d NGFW throughput is measured with IPS, application control, and web filter enabled, based on BreakingPoint Realworld-IPS-Enterprise-Traffic-Mix, bidirectional across multiple ports.
- e Threat protection throughput is measured with IPS, application control, web filter, and cloud-based antivirus and SSL inspection enabled (as part of an active Advanced Threat Protection subscription), based on BreakingPoint Realworld-IPS-Enterprise-Traffic-Mix, bidirectional across multiple ports.
- f Depending on feature set; for more detailed information on sizing, please use the free sizing calculator on [Barracuda Campus](#).
- g MTBF according to common usage. High load on SSD and extreme environmental conditions might reduce MTBF.

Errors and omissions excepted. Specifications subject to change without notice.



# CloudGen Firewall F400C standard model

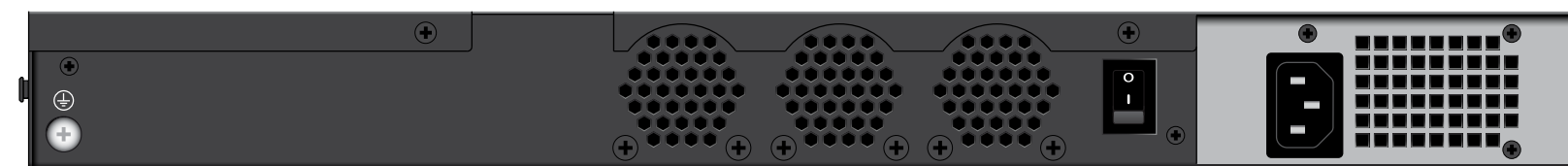
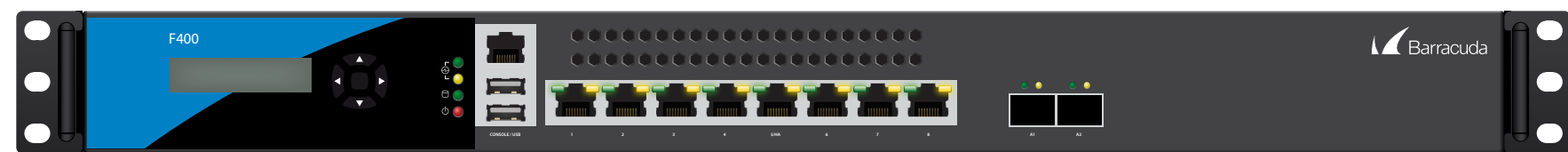

INTERFACES	
Copper ethernet NICs (1 GbE)	8x
SFP+ fiber NICs (10 GbE)	2x
USB 3.0	2x
Serial / console	1x RJ45
PERFORMANCE [AS OF FIRMWARE RELEASE 8.3.X]	
Firewall throughput [Gbps] <sup>[a]</sup>	13
SD-WAN throughput [AES-128, TINA std hash, Gbps] <sup>[b]</sup>	3.6
SD-WAN throughput [AES-256, TINA std hash, Gbps] <sup>[b]</sup>	2.1
SD-WAN throughput [AES-256, SHA256, Gbps] <sup>[b]</sup>	1.1
SD-WAN throughput [AES-256, MD5, Gbps] <sup>[b]</sup>	2.7
SD-WAN throughput [AES-256, GCM, Gbps] <sup>[b]</sup>	1.2
IPS throughput [Gbps] <sup>[c]</sup>	4.2
NGFW throughput [Gbps] <sup>[d]</sup>	3.7
Threat protection throughput [Gbps] <sup>[e]</sup>	3.1
Concurrent sessions	500,000
New sessions/s	20,000
Recommended number of concurrent users <sup>[f]</sup>	300-1,000
MEMORY	
RAM [GB]	8
MASS STORAGE	
Type	SSD
Size [(GB) or better]	120
SSD MTBF [hours]	1,200,000
SIZE, WEIGHT, DIMENSIONS	
Weight appliance [lbs] / [kg]	18.5 / 8.4
Appliance size: width x depth x height [in]	17.3 x 17.3 x 1.7
Appliance size: width x depth x height [mm]	440 x 440 x 44
Weight carton with appliance [lbs] / [kg]	20.7 / 9.4
Carton size: width x depth x height [in]	21.85 x 29.7 x 8
Carton size: width x depth x height [mm]	555 x 755 x 203
Form factor	1U rack mount
HARDWARE	
Display	✓
Cooling	Fan
ENVIRONMENTAL	
Noise emission [db/A]	n/a
Operating temperature [°F] / [°C]	+32 to +104 / 0 to +40
Storage temperature [°F] / [°C]	-5 to +160 / -20 to +70
Operating humidity (non-condensing)	10% to 85%

MTBF [SYSTEM]	
MTBF [yrs.] <sup>[g]</sup>	> 5
POWER AND EFFICIENCY	
Power supply	Single
Power supply type	Internal
Power type [AC/DC]	AC
Input ratings [Volts]	100-240
Input frequency [Hz]	50-60
Auto sense	✓
Max. power draw [W]	192
Max. power draw @ 120V [Amps]	14
Max. power draw @ 230V [Amps]	7
Max. heat dissipation [W]	29
Max. heat dissipation [BTU]	98
Energy efficiency (average)	> 85%
CERTIFICATIONS AND COMPLIANCE (ALSO SEE PAGE 104 FF)	
CE emissions	✓
CE electrical safety	✓
FCC emissions	✓
ROHS compliant	✓
PACKAGING CONTENT	
Appliance	✓
Straight network cable	✓
Direct power-to-wall outlet	✓
USB flash drive for recovery and installation	✓
Quick start guide	✓
2x Barracuda L-shape rack mount bracket	✓
Barracuda rail kit	Optional

All performance values are measured under optimized conditions and are to be considered as „up to“ values and may vary depending on system configuration and infrastructure:

- a Firewall throughput measured with large UDP packets (MTU1500), bi-directional across multiple ports.
- b SD-WAN throughput is based on 1415 Byte UDP packets, bidirectional using BreakingPoint traffic generator.
- c IPS throughput is measured with large UDP packets (MTU1500) and across multiple ports.
- d NGFW throughput is measured with IPS, application control, and web filter enabled, based on BreakingPoint Realworld-IPS-Enterprise-Traffic-Mix, bidirectional across multiple ports.
- e Threat protection throughput is measured with IPS, application control, web filter, and cloud-based antivirus and SSL inspection enabled (as part of an active Advanced Threat Protection subscription), based on BreakingPoint Realworld-IPS-Enterprise-Traffic-Mix, bidirectional across multiple ports.
- f Depending on feature set; for more detailed information on sizing, please use the free sizing calculator on [Barracuda Campus](#).
- g MTBF according to common usage. High load on SSD and extreme environmental conditions might reduce MTBF.

Errors and omissions excepted. Specifications subject to change without notice.



# CloudGen Firewall F400C.F20

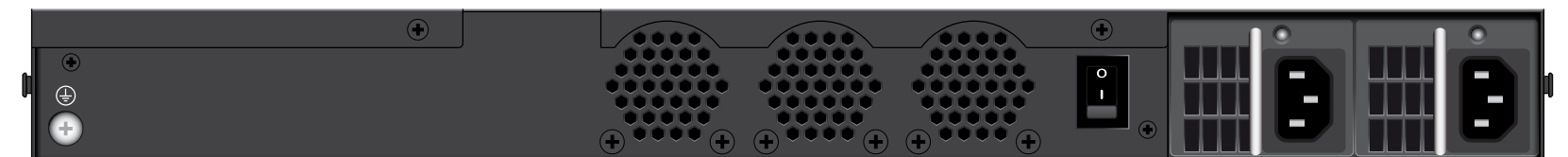
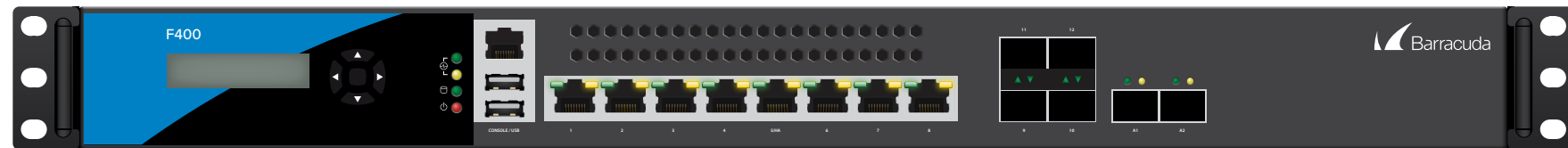

INTERFACES	
Copper ethernet NICs (1 GbE)	8x
SFP fiber NICs (1 GbE)	4x
SFP+ fiber NICs (10 GbE)	2x
USB 3.0	2x
Serial / console	1x RJ45
PERFORMANCE [AS OF FIRMWARE RELEASE 8.3.X]	
Firewall throughput [Gbps] <sup>[a]</sup>	13
SD-WAN throughput [AES-128, TINA std hash, Gbps] <sup>[b]</sup>	3.6
SD-WAN throughput [AES-256, TINA std hash, Gbps] <sup>[b]</sup>	2.1
SD-WAN throughput [AES-256, SHA256, Gbps] <sup>[b]</sup>	1.1
SD-WAN throughput [AES-256, MD5, Gbps] <sup>[b]</sup>	2.7
SD-WAN throughput [AES-256, GCM, Gbps] <sup>[b]</sup>	1.2
IPS throughput [Gbps] <sup>[c]</sup>	4.2
NGFW throughput [Gbps] <sup>[d]</sup>	3.7
Threat protection throughput [Gbps] <sup>[e]</sup>	3.1
Concurrent sessions	500,000
New sessions/s	20,000
Recommended number of concurrent users <sup>[f]</sup>	300-1,000
MEMORY	
RAM [GB]	8
MASS STORAGE	
Type	SSD
Size [(GB) or better]	120
SSD MTBF [hours]	1,200,000
SIZE, WEIGHT, DIMENSIONS	
Weight appliance [lbs] / [kg]	20.5 / 9.3
Appliance size: width x depth x height [in]	17.3 x 17.3 x 1.7
Appliance size: width x depth x height [mm]	440 x 440 x 44
Weight carton with appliance [lbs] / [kg]	22.7 / 10.3
Carton size: width x depth x height [in]	21.85 x 29.7 x 8
Carton size: width x depth x height [mm]	555 x 755 x 203
Form factor	1U rack mount
HARDWARE	
Display	✓
Cooling	Fan
ENVIRONMENTAL	
Noise emission [db/A]	n/a
Operating temperature [°F] / [°C]	+32 to +104 / 0 to +40
Storage temperature [°F] / [°C]	-5 to +160 / -20 to +70
Operating humidity (non-condensing)	10% to 85%

MTBF [SYSTEM]	
MTBF [yrs.] <sup>[g]</sup>	> 5
POWER AND EFFICIENCY	
Power supply	Dual hot swap
Power supply type	Internal
Power type [AC/DC]	AC
Input ratings [Volts]	100-240
Input frequency [Hz]	50-60
Auto sense	✓
Max. power draw [W]	208
Max. power draw @ 120V [Amps]	15
Max. power draw @ 230V [Amps]	7.5
Max. heat dissipation [W]	31
Max. heat dissipation [BTU]	106
Energy efficiency (average)	> 85%
CERTIFICATIONS AND COMPLIANCE (ALSO SEE PAGE 104 FF)	
CE emissions	✓
CE electrical safety	✓
FCC emissions	✓
ROHS compliant	✓
PACKAGING CONTENT	
Appliance	✓
Straight network cable	✓
Direct power-to-wall outlet	✓
USB flash drive for recovery and installation	✓
Quick start guide	✓
2x Barracuda L-shape rack mount bracket	✓
Barracuda rail kit	Optional

All performance values are measured under optimized conditions and are to be considered as „up to“ values and may vary depending on system configuration and infrastructure:

- a Firewall throughput measured with large UDP packets (MTU1500), bi-directional across multiple ports.
- b SD-WAN throughput is based on 1415 Byte UDP packets, bidirectional using BreakingPoint traffic generator.
- c IPS throughput is measured with large UDP packets (MTU1500) and across multiple ports.
- d NGFW throughput is measured with IPS, application control, and web filter enabled, based on BreakingPoint Realworld-IPS-Enterprise-Traffic-Mix, bidirectional across multiple ports.
- e Threat protection throughput is measured with IPS, application control, web filter, and cloud-based antivirus and SSL inspection enabled (as part of an active Advanced Threat Protection subscription), based on BreakingPoint Realworld-IPS-Enterprise-Traffic-Mix, bidirectional across multiple ports.
- f Depending on feature set; for more detailed information on sizing, please use the free sizing calculator on [Barracuda Campus](#).
- g MTBF according to common usage. High load on SSD and extreme environmental conditions might reduce MTBF.

Errors and omissions excepted. Specifications subject to change without notice.



# CloudGen Firewall F600D.C10

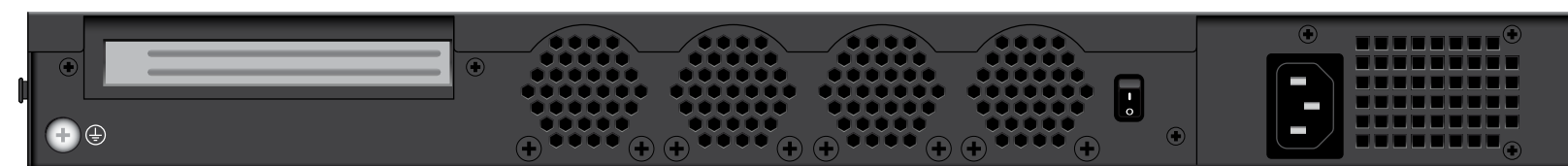
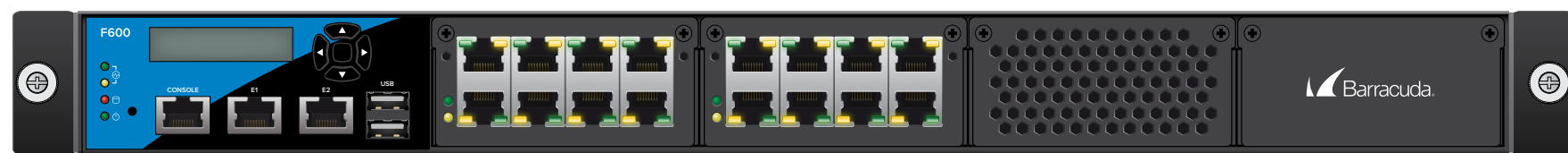

INTERFACES	
Copper ethernet NICs (1 GbE)	18x
USB 2.0	2x
Serial / console	1x RJ45
PERFORMANCE [AS OF FIRMWARE RELEASE 8.3.X]	
Firewall throughput [Gbps] <sup>[a]</sup>	15
SD-WAN throughput [AES-128, TINA std hash, Gbps] <sup>[b]</sup>	3.8
SD-WAN throughput [AES-256, TINA std hash, Gbps] <sup>[b]</sup>	2.6
SD-WAN throughput [AES-256, SHA256, Gbps] <sup>[b]</sup>	1.5
SD-WAN throughput [AES-256, MD5, Gbps] <sup>[b]</sup>	3.8
SD-WAN throughput [AES-256, GCM, Gbps] <sup>[b]</sup>	1.5
IPS throughput [Gbps] <sup>[c]</sup>	4.8
NGFW throughput [Gbps] <sup>[d]</sup>	4.2
Threat protection throughput [Gbps] <sup>[e]</sup>	4.0
Concurrent sessions	2,100,000
New sessions/s	115,000
Recommended number of concurrent users <sup>[f]</sup>	1,000-4,000
MEMORY	
RAM [GB]	8
MASS STORAGE	
Type	SSD
Size [(GB) or better]	240
SSD MTBF [hours]	1,200,000
SIZE, WEIGHT, DIMENSIONS	
Weight appliance [lbs] / [kg]	22.0 / 10.0
Appliance size: width x depth x height [in]	17.3 x 19.7 x 1.7
Appliance size: width x depth x height [mm]	440 x 500 x 44
Weight carton with appliance [lbs] / [kg]	26.5 / 12.0
Carton size: width x depth x height [in]	25.6 x 23.2 x 7.9
Carton size: width x depth x height [mm]	650 x 590 x 200
Form factor	1U rack mount
HARDWARE	
Display	✓
Cooling	Fan
ENVIRONMENTAL	
Noise emission [db/A]	n/a
Operating temperature [°F] / [°C]	+32 to +104 / 0 to +40
Storage temperature [°F] / [°C]	-4 to +167 / -20 to +75
Operating humidity (non-condensing)	10% to 85%

MTBF [SYSTEM]	
MTBF [yrs.] <sup>[g]</sup>	> 5
POWER AND EFFICIENCY	
Power supply	Single
Power supply type	Internal
Power type [AC/DC]	AC
Input ratings [Volts]	100-240
Input frequency [Hz]	50-60
Auto sense	✓
Max. power draw [W]	300
Max. power draw @ 120V [Amps]	5
Max. power draw @ 230V [Amps]	2.6
Max. heat dissipation [W]	300
Max. heat dissipation [BTU]	1,024
Energy efficiency (average)	> 80%
CERTIFICATIONS AND COMPLIANCE (ALSO SEE PAGE 104 FF)	
CE emissions	✓
CE electrical safety	✓
FCC emissions	✓
ROHS compliant	✓
PACKAGING CONTENT	
Appliance	✓
Straight network cable	✓
Direct power-to-wall outlet	✓
USB flash drive for recovery and installation	✓
Quick start guide	✓
2x Barracuda L-shape rack mount bracket	✓
Barracuda rail kit	✓

All performance values are measured under optimized conditions and are to be considered as „up to“ values and may vary depending on system configuration and infrastructure:

- a Firewall throughput measured with large UDP packets (MTU1500), bi-directional across multiple ports.
- b SD-WAN throughput is based on 1415 Byte UDP packets, bidirectional using BreakingPoint traffic generator.
- c IPS throughput is measured with large UDP packets (MTU1500) and across multiple ports.
- d NGFW throughput is measured with IPS, application control, and web filter enabled, based on BreakingPoint Realworld-IPS-Enterprise-Traffic-Mix, bidirectional across multiple ports.
- e Threat protection throughput is measured with IPS, application control, web filter, and cloud-based antivirus and SSL inspection enabled (as part of an active Advanced Threat Protection subscription), based on BreakingPoint Realworld-IPS-Enterprise-Traffic-Mix, bidirectional across multiple ports.
- f Depending on feature set; for more detailed information on sizing, please use the free sizing calculator on [Barracuda Campus](#).
- g MTBF according to common usage. High load on SSD and extreme environmental conditions might reduce MTBF.

Errors and omissions excepted. Specifications subject to change without notice.



# CloudGen Firewall F600D.C20

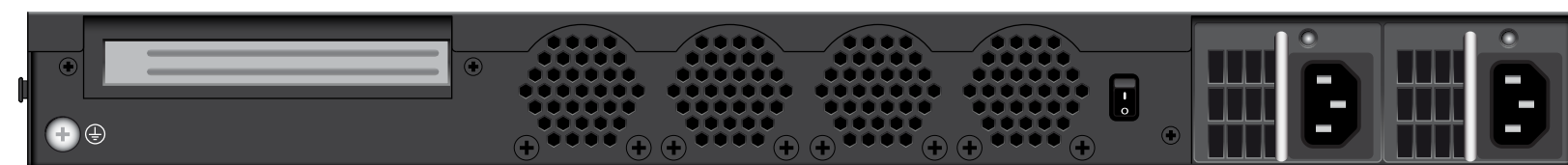
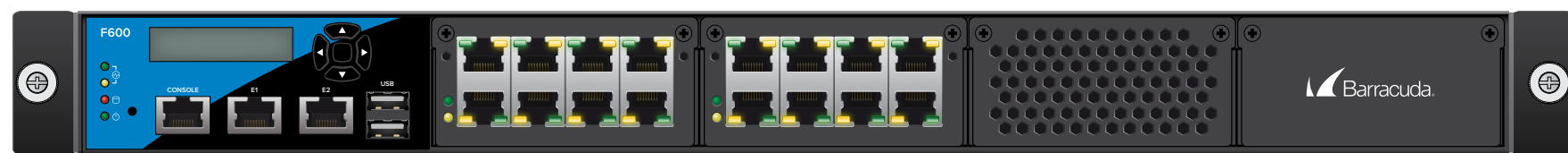

INTERFACES	
Copper ethernet NICs (1 GbE)	18x
USB 2.0	2x
Serial / console	1x RJ45
PERFORMANCE [AS OF FIRMWARE RELEASE 8.3.X]	
Firewall throughput [Gbps] <sup>[a]</sup>	15
SD-WAN throughput [AES-128, TINA std hash, Gbps] <sup>[b]</sup>	3.8
SD-WAN throughput [AES-256, TINA std hash, Gbps] <sup>[b]</sup>	2.6
SD-WAN throughput [AES-256, SHA256, Gbps] <sup>[b]</sup>	1.5
SD-WAN throughput [AES-256, MD5, Gbps] <sup>[b]</sup>	3.8
SD-WAN throughput [AES-256, GCM, Gbps] <sup>[b]</sup>	1.5
IPS throughput [Gbps] <sup>[c]</sup>	4.8
NGFW throughput [Gbps] <sup>[d]</sup>	4.2
Threat protection throughput [Gbps] <sup>[e]</sup>	4.0
Concurrent sessions	2,100,000
New sessions/s	115,000
Recommended number of concurrent users <sup>[f]</sup>	1,000-4,000
MEMORY	
RAM [GB]	8
MASS STORAGE	
Type	SSD
Size [(GB) or better]	240
SSD MTBF [hours]	1,200,000
SIZE, WEIGHT, DIMENSIONS	
Weight appliance [lbs] / [kg]	22.0 / 10.0
Appliance size: width x depth x height [in]	17.3 x 19.7 x 1.7
Appliance size: width x depth x height [mm]	440 x 500 x 44
Weight carton with appliance [lbs] / [kg]	26.5 / 12.0
Carton size: width x depth x height [in]	25.6 x 23.2 x 7.9
Carton size: width x depth x height [mm]	650 x 590 x 200
Form factor	1U rack mount
HARDWARE	
Display	✓
Cooling	Fan
ENVIRONMENTAL	
Noise emission [db/A]	n/a
Operating temperature [°F] / [°C]	+32 to +104 / 0 to +40
Storage temperature [°F] / [°C]	-4 to +167 / -20 to +75
Operating humidity (non-condensing)	10% to 85%

MTBF [SYSTEM]	
MTBF [yrs.] <sup>[g]</sup>	> 5
POWER AND EFFICIENCY	
Power supply	Dual hot swap
Power supply type	Internal
Power type [AC/DC]	AC
Input ratings [Volts]	100-240
Input frequency [Hz]	50-60
Auto sense	✓
Max. power draw [W]	300
Max. power draw @ 120V [Amps]	5
Max. power draw @ 230V [Amps]	2.6
Max. heat dissipation [W]	300
Max. heat dissipation [BTU]	1,024
Energy efficiency (average)	> 80%
CERTIFICATIONS AND COMPLIANCE (ALSO SEE PAGE 104 FF)	
CE emissions	✓
CE electrical safety	✓
FCC emissions	✓
ROHS compliant	✓
PACKAGING CONTENT	
Appliance	✓
Straight network cable	✓
Direct power-to-wall outlet	✓
USB flash drive for recovery and installation	✓
Quick start guide	✓
2x Barracuda L-shape rack mount bracket	✓
Barracuda rail kit	✓

All performance values are measured under optimized conditions and are to be considered as „up to“ values and may vary depending on system configuration and infrastructure:

- a Firewall throughput measured with large UDP packets (MTU1500), bi-directional across multiple ports.
- b SD-WAN throughput is based on 1415 Byte UDP packets, bidirectional using BreakingPoint traffic generator.
- c IPS throughput is measured with large UDP packets (MTU1500) and across multiple ports.
- d NGFW throughput is measured with IPS, application control, and web filter enabled, based on BreakingPoint Realworld-IPS-Enterprise-Traffic-Mix, bidirectional across multiple ports.
- e Threat protection throughput is measured with IPS, application control, web filter, and cloud-based antivirus and SSL inspection enabled (as part of an active Advanced Threat Protection subscription), based on BreakingPoint Realworld-IPS-Enterprise-Traffic-Mix, bidirectional across multiple ports.
- f Depending on feature set; for more detailed information on sizing, please use the free sizing calculator on [Barracuda Campus](#).
- g MTBF according to common usage. High load on SSD and extreme environmental conditions might reduce MTBF.

Errors and omissions excepted. Specifications subject to change without notice.



# CloudGen Firewall F600D.F10

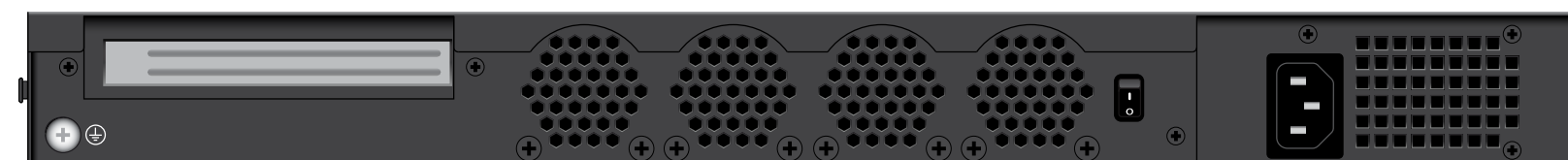
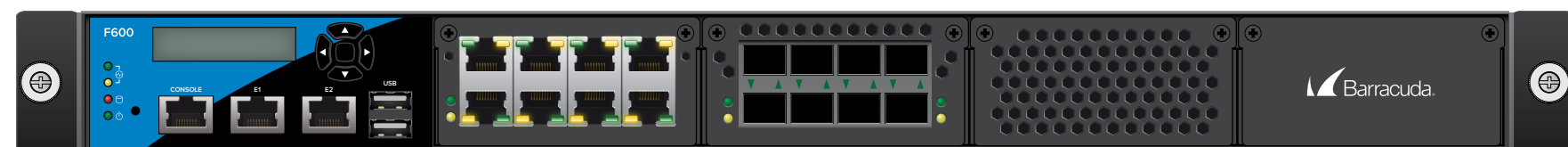

INTERFACES	
Copper ethernet NICs (1 GbE)	10x
SFP fiber NICs (1 GbE)	8x
USB 2.0	2x
Serial / console	1x RJ45
PERFORMANCE [AS OF FIRMWARE RELEASE 8.3.X]	
Firewall throughput [Gbps] <sup>[a]</sup>	15
SD-WAN throughput [AES-128, TINA std hash, Gbps] <sup>[b]</sup>	3.8
SD-WAN throughput [AES-256, TINA std hash, Gbps] <sup>[b]</sup>	2.6
SD-WAN throughput [AES-256, SHA256, Gbps] <sup>[b]</sup>	1.5
SD-WAN throughput [AES-256, MD5, Gbps] <sup>[b]</sup>	3.8
SD-WAN throughput [AES-256, GCM, Gbps] <sup>[b]</sup>	1.5
IPS throughput [Gbps] <sup>[c]</sup>	4.8
NGFW throughput [Gbps] <sup>[d]</sup>	4.2
Threat protection throughput [Gbps] <sup>[e]</sup>	4.0
Concurrent sessions	2,100,000
New sessions/s	115,000
Recommended number of concurrent users <sup>[f]</sup>	1,000-4,000
MEMORY	
RAM [GB]	8
MASS STORAGE	
Type	SSD
Size [(GB) or better]	240
SSD MTBF [hours]	1,200,000
SIZE, WEIGHT, DIMENSIONS	
Weight appliance [lbs] / [kg]	22.0 / 10.0
Appliance size: width x depth x height [in]	17.3 x 19.7 x 1.7
Appliance size: width x depth x height [mm]	440 x 500 x 44
Weight carton with appliance [lbs] / [kg]	26.5 / 12.0
Carton size: width x depth x height [in]	25.6 x 23.2 x 7.9
Carton size: width x depth x height [mm]	650 x 590 x 200
Form factor	1U rack mount
HARDWARE	
Display	✓
Cooling	Fan
ENVIRONMENTAL	
Noise emission [db/A]	n/a
Operating temperature [°F] / [°C]	+32 to +104 / 0 to +40
Storage temperature [°F] / [°C]	-4 to +167 / -20 to +75
Operating humidity (non-condensing)	10% to 85%

MTBF [SYSTEM]	
MTBF [yrs.] <sup>[g]</sup>	> 5
POWER AND EFFICIENCY	
Power supply	Single
Power supply type	Internal
Power type [AC/DC]	AC
Input ratings [Volts]	100-240
Input frequency [Hz]	50-60
Auto sense	✓
Max. power draw [W]	300
Max. power draw @ 120V [Amps]	5
Max. power draw @ 230V [Amps]	2.6
Max. heat dissipation [W]	300
Max. heat dissipation [BTU]	1,024
Energy efficiency (average)	> 80%
CERTIFICATIONS AND COMPLIANCE (ALSO SEE PAGE 104 FF)	
CE emissions	✓
CE electrical safety	✓
FCC emissions	✓
ROHS compliant	✓
PACKAGING CONTENT	
Appliance	✓
Straight network cable	✓
Direct power-to-wall outlet	✓
USB flash drive for recovery and installation	✓
Quick start guide	✓
2x Barracuda L-shape rack mount bracket	✓
Barracuda rail kit	✓

All performance values are measured under optimized conditions and are to be considered as „up to“ values and may vary depending on system configuration and infrastructure:

- a Firewall throughput measured with large UDP packets (MTU1500), bi-directional across multiple ports.
- b SD-WAN throughput is based on 1415 Byte UDP packets, bidirectional using BreakingPoint traffic generator.
- c IPS throughput is measured with large UDP packets (MTU1500) and across multiple ports.
- d NGFW throughput is measured with IPS, application control, and web filter enabled, based on BreakingPoint Realworld-IPS-Enterprise-Traffic-Mix, bidirectional across multiple ports.
- e Threat protection throughput is measured with IPS, application control, web filter, and cloud-based antivirus and SSL inspection enabled (as part of an active Advanced Threat Protection subscription), based on BreakingPoint Realworld-IPS-Enterprise-Traffic-Mix, bidirectional across multiple ports.
- f Depending on feature set; for more detailed information on sizing, please use the free sizing calculator on [Barracuda Campus](#).
- g MTBF according to common usage. High load on SSD and extreme environmental conditions might reduce MTBF.

Errors and omissions excepted. Specifications subject to change without notice.



# CloudGen Firewall F600D.F20

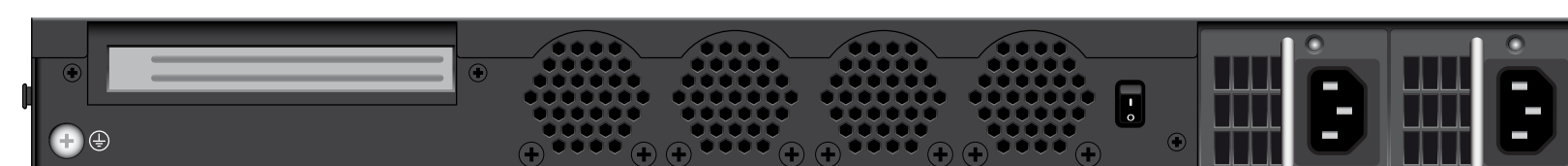
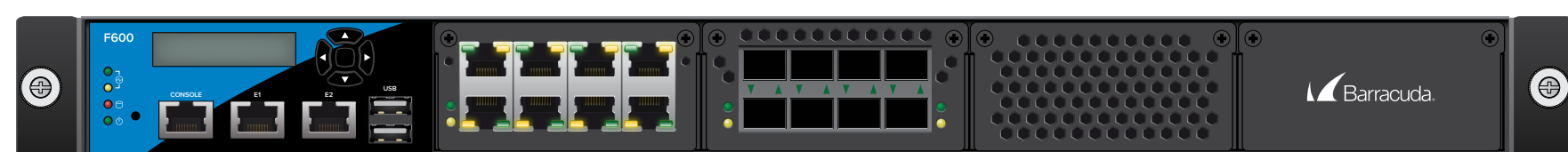

INTERFACES	
Copper ethernet NICs (1 GbE)	10x
SFP fiber NICs (1 GbE)	8x
USB 2.0	2x
Serial / console	1x RJ45
PERFORMANCE [AS OF FIRMWARE RELEASE 8.3.X]	
Firewall throughput [Gbps] <sup>[a]</sup>	15
SD-WAN throughput [AES-128, TINA std hash, Gbps] <sup>[b]</sup>	3.8
SD-WAN throughput [AES-256, TINA std hash, Gbps] <sup>[b]</sup>	2.6
SD-WAN throughput [AES-256, SHA256, Gbps] <sup>[b]</sup>	1.5
SD-WAN throughput [AES-256, MD5, Gbps] <sup>[b]</sup>	3.8
SD-WAN throughput [AES-256, GCM, Gbps] <sup>[b]</sup>	1.5
IPS throughput [Gbps] <sup>[c]</sup>	4.8
NGFW throughput [Gbps] <sup>[d]</sup>	4.2
Threat protection throughput [Gbps] <sup>[e]</sup>	4.0
Concurrent sessions	2,100,000
New sessions/s	115,000
Recommended number of concurrent users <sup>[f]</sup>	1,000-4,000
MEMORY	
RAM [GB]	8
MASS STORAGE	
Type	SSD
Size [(GB) or better]	240
SSD MTBF [hours]	1,200,000
SIZE, WEIGHT, DIMENSIONS	
Weight appliance [lbs] / [kg]	22.0 / 10.0
Appliance size: width x depth x height [in]	17.3 x 19.7 x 1.7
Appliance size: width x depth x height [mm]	440 x 500 x 44
Weight carton with appliance [lbs] / [kg]	26.5 / 12.0
Carton size: width x depth x height [in]	25.6 x 23.2 x 7.9
Carton size: width x depth x height [mm]	650 x 590 x 200
Form factor	1U rack mount
HARDWARE	
Display	✓
Cooling	Fan
ENVIRONMENTAL	
Noise emission [db/A]	n/a
Operating temperature [°F] / [°C]	+32 to +104 / 0 to +40
Storage temperature [°F] / [°C]	-4 to +167 / -20 to +75
Operating humidity (non-condensing)	10% to 85%

MTBF [SYSTEM]	
MTBF [yrs.] <sup>[g]</sup>	> 5
POWER AND EFFICIENCY	
Power supply	Dual hot swap
Power supply type	Internal
Power type [AC/DC]	AC
Input ratings [Volts]	100-240
Input frequency [Hz]	50-60
Auto sense	✓
Max. power draw [W]	300
Max. power draw @ 120V [Amps]	5
Max. power draw @ 230V [Amps]	2.6
Max. heat dissipation [W]	300
Max. heat dissipation [BTU]	1,024
Energy efficiency (average)	> 80%
CERTIFICATIONS AND COMPLIANCE (ALSO SEE PAGE 104 FF)	
CE emissions	✓
CE electrical safety	✓
FCC emissions	✓
ROHS compliant	✓
PACKAGING CONTENT	
Appliance	✓
Straight network cable	✓
Direct power-to-wall outlet	✓
USB flash drive for recovery and installation	✓
Quick start guide	✓
2x Barracuda L-shape rack mount bracket	✓
Barracuda rail kit	✓

All performance values are measured under optimized conditions and are to be considered as „up to“ values and may vary depending on system configuration and infrastructure:

- a Firewall throughput measured with large UDP packets (MTU1500), bi-directional across multiple ports.
- b SD-WAN throughput is based on 1415 Byte UDP packets, bidirectional using BreakingPoint traffic generator.
- c IPS throughput is measured with large UDP packets (MTU1500) and across multiple ports.
- d NGFW throughput is measured with IPS, application control, and web filter enabled, based on BreakingPoint Realworld-IPS-Enterprise-Traffic-Mix, bidirectional across multiple ports.
- e Threat protection throughput is measured with IPS, application control, web filter, and cloud-based antivirus and SSL inspection enabled (as part of an active Advanced Threat Protection subscription), based on BreakingPoint Realworld-IPS-Enterprise-Traffic-Mix, bidirectional across multiple ports.
- f Depending on feature set; for more detailed information on sizing, please use the free sizing calculator on [Barracuda Campus](#).
- g MTBF according to common usage. High load on SSD and extreme environmental conditions might reduce MTBF.

Errors and omissions excepted. Specifications subject to change without notice.



# CloudGen Firewall F600D.E20

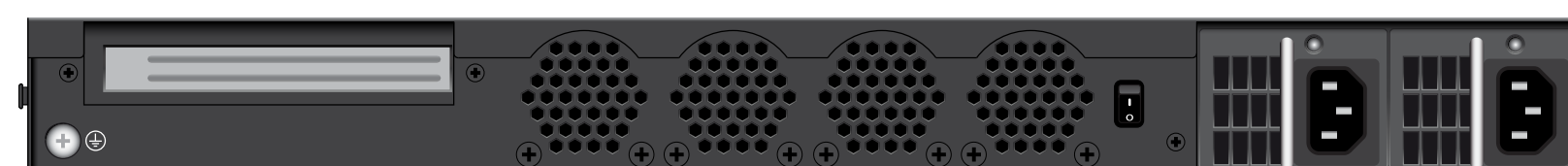
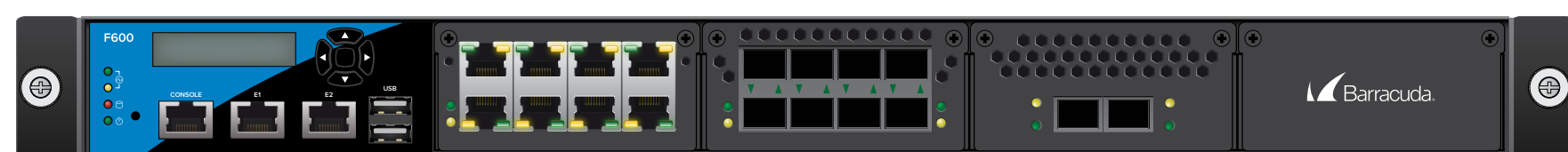

INTERFACES	
Copper ethernet NICs (1 GbE)	10x
SFP fiber NICs (1 GbE)	8x
SFP+ fiber NICs (10 GbE)	2x
USB 2.0	2x
Serial / console	1x RJ45
PERFORMANCE [AS OF FIRMWARE RELEASE 8.3.X]	
Firewall throughput [Gbps] <sup>[a]</sup>	20
SD-WAN throughput [AES-128, TINA std hash, Gbps] <sup>[b]</sup>	6.8
SD-WAN throughput [AES-256, TINA std hash, Gbps] <sup>[b]</sup>	5.2
SD-WAN throughput [AES-256, SHA256, Gbps] <sup>[b]</sup>	2.8
SD-WAN throughput [AES-256, MD5, Gbps] <sup>[b]</sup>	5.2
SD-WAN throughput [AES-256, GCM, Gbps] <sup>[b]</sup>	2.8
IPS throughput [Gbps] <sup>[c]</sup>	8.0
NGFW throughput [Gbps] <sup>[d]</sup>	6.4
Threat protection throughput [Gbps] <sup>[e]</sup>	5.8
Concurrent sessions	2,100,000
New sessions/s	115,000
Recommended number of concurrent users <sup>[f]</sup>	1,000-4,000
MEMORY	
RAM [GB]	8
MASS STORAGE	
Type	SSD
Size [(GB) or better]	240
SSD MTBF [hours]	1,200,000
SIZE, WEIGHT, DIMENSIONS	
Weight appliance [lbs] / [kg]	22.0 / 10.0
Appliance size: width x depth x height [in]	17.3 x 19.7 x 1.7
Appliance size: width x depth x height [mm]	440 x 500 x 44
Weight carton with appliance [lbs] / [kg]	26.5 / 12.0
Carton size: width x depth x height [in]	25.6 x 23.2 x 7.9
Carton size: width x depth x height [mm]	650 x 590 x 200
Form factor	1U rack mount
HARDWARE	
Display	✓
Cooling	Fan
ENVIRONMENTAL	
Noise emission [db/A]	n/a
Operating temperature [°F] / [°C]	+32 to +104 / 0 to +40
Storage temperature [°F] / [°C]	-4 to +167 / -20 to +75
Operating humidity (non-condensing)	10% to 85%

MTBF [SYSTEM]	
MTBF [yrs.] <sup>[g]</sup>	> 5
POWER AND EFFICIENCY	
Power supply	Dual hot swap
Power supply type	Internal
Power type [AC/DC]	AC
Input ratings [Volts]	100-240
Input frequency [Hz]	50-60
Auto sense	✓
Max. power draw [W]	300
Max. power draw @ 120V [Amps]	5
Max. power draw @ 230V [Amps]	2.6
Max. heat dissipation [W]	300
Max. heat dissipation [BTU]	1,024
Energy efficiency (average)	> 80%
CERTIFICATIONS AND COMPLIANCE (ALSO SEE PAGE 104 FF)	
CE emissions	✓
CE electrical safety	✓
FCC emissions	✓
ROHS compliant	✓
PACKAGING CONTENT	
Appliance	✓
Straight network cable	✓
Direct power-to-wall outlet	✓
USB flash drive for recovery and installation	✓
Quick start guide	✓
2x Barracuda L-shape rack mount bracket	✓
Barracuda rail kit	✓

All performance values are measured under optimized conditions and are to be considered as „up to“ values and may vary depending on system configuration and infrastructure:

- a Firewall throughput measured with large UDP packets (MTU1500), bi-directional across multiple ports.
- b SD-WAN throughput is based on 1415 Byte UDP packets, bidirectional using BreakingPoint traffic generator.
- c IPS throughput is measured with large UDP packets (MTU1500) and across multiple ports.
- d NGFW throughput is measured with IPS, application control, and web filter enabled, based on BreakingPoint Realworld-IPS-Enterprise-Traffic-Mix, bidirectional across multiple ports.
- e Threat protection throughput is measured with IPS, application control, web filter, and cloud-based antivirus and SSL inspection enabled (as part of an active Advanced Threat Protection subscription), based on BreakingPoint Realworld-IPS-Enterprise-Traffic-Mix, bidirectional across multiple ports.
- f Depending on feature set; for more detailed information on sizing, please use the free sizing calculator on [Barracuda Campus](#).
- g MTBF according to common usage. High load on SSD and extreme environmental conditions might reduce MTBF.

Errors and omissions excepted. Specifications subject to change without notice.



SPECIFICATIONS - HIGH-LEVEL MODELS

# CloudGen Firewall F800C.CCC

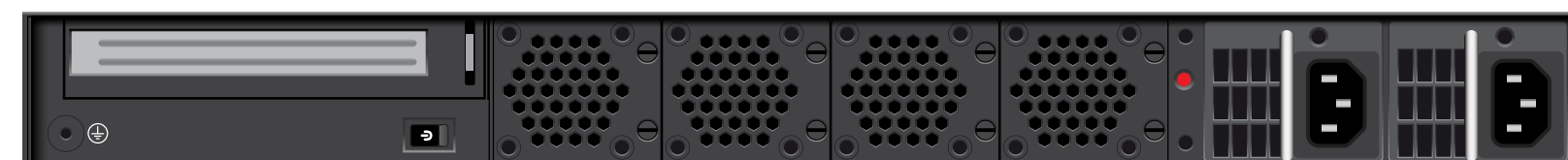
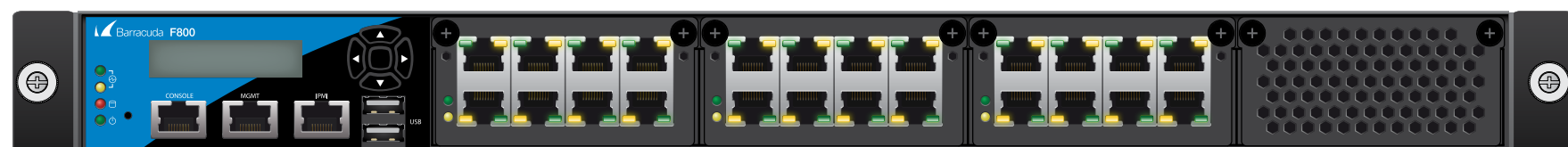

INTERFACES *	
Copper ethernet NICs (1 GbE)	24x
USB 2.0	2x
Serial / console	1x RJ45
PERFORMANCE [AS OF FIRMWARE RELEASE 8.3.X]	
Firewall throughput [Gbps] <sup>[a]</sup>	30
SD-WAN throughput [AES-128, TINA std hash, Gbps] <sup>[b]</sup>	7.5
SD-WAN throughput [AES-256, TINA std hash, Gbps] <sup>[b]</sup>	6.7
SD-WAN throughput [AES-256, SHA256, Gbps] <sup>[b]</sup>	5.3
SD-WAN throughput [AES-256, MD5, Gbps] <sup>[b]</sup>	6.5
SD-WAN throughput [AES-256, GCM, Gbps] <sup>[b]</sup>	6.5
IPS throughput [Gbps] <sup>[c]</sup>	8.3
NGFW throughput [Gbps] <sup>[d]</sup>	7.7
Threat protection throughput [Gbps] <sup>[e]</sup>	7.6
Concurrent sessions	2,500,000
New sessions/s	180,000
Recommended number of concurrent users <sup>[f]</sup>	4,000-6,000
MEMORY	
RAM ([GB] or better)	24
MASS STORAGE	
Type	SSD
Size ([GB] or better)	430
SSD MTBF [hours]	1,200,000
SIZE, WEIGHT, DIMENSIONS	
Weight appliance [lbs] / [kg]	26.0 / 12.0
Appliance size: width x depth x height [in]	17.2 x 22.4 x 1.7
Appliance size: width x depth x height [mm]	440 x 570 x 44
Weight carton with appliance [lbs] / [kg]	44.0 / 20.0
Carton size: width x depth x height [in]	23.0 x 30.5 x 9.0
Carton size: width x depth x height [mm]	585 x 775 x 229
Form factor	1U rack mount
HARDWARE	
Display	✓
Cooling	Fan
ENVIRONMENTAL	
Noise emission [db/A]	< 75
Operating temperature [°F] / [°C]	+32 to +104 / 0 to +40
Storage temperature [°F] / [°C]	-4 to +167 / -20 to +75
Operating humidity (non-condensing)	10% to 85%

MTBF [SYSTEM]	
MTBF [yrs.] <sup>[g]</sup>	> 4
POWER AND EFFICIENCY	
Power supply	Dual hot swap
Power supply type	Internal
Power type [AC/DC]	AC
Input ratings [Volts]	100-240
Input frequency [Hz]	50-60
Auto sense	✓
Max. power draw [W]	500
Max. power draw @ 120V [Amps]	8
Max. power draw @ 230V [Amps]	4
Max. heat dissipation [W]	~ 400
Max. heat dissipation [BTU]	~ 1,366
Energy efficiency (average)	88%
CERTIFICATIONS AND COMPLIANCE (ALSO SEE PAGE 104 FF)	
CE emissions	✓
CE electrical safety	✓
FCC emissions	✓
ROHS compliant	✓
PACKAGING CONTENT	
Appliance	✓
Straight network cable	✓
Direct power-to-wall outlet	✓
USB flash drive for recovery and installation	✓
Quick start guide	✓
2x Barracuda L-shape rack mount bracket	✓
Barracuda rail kit	✓

\* Available sub models can be re-configured in the field. However, the re-configuration of network modules can be only applied to meet with available sub models. E.g., you may reconfigure from model CCC to CCE or CCF but not to a model CFE as such a sub model is not available for F800. Network modules may be replaced in case of failure. Spare parts for redundant power supply can be ordered separately.

All performance values are measured under optimized conditions and are to be considered as „up to“ values and may vary depending on system configuration and infrastructure:

- a Firewall throughput measured with large UDP packets (MTU1500), bi-directional across multiple ports.
- b SD-WAN throughput is based on 1415 Byte UDP packets, bidirectional using BreakingPoint traffic generator.
- c IPS throughput is measured with large UDP packets (MTU1500) and across multiple ports.
- d NGFW throughput is measured with IPS, application control, and web filter enabled, based on BreakingPoint Realworld-IPS-Enterprise-Traffic-Mix, bidirectional across multiple ports.
- e Threat protection throughput is measured with IPS, application control, web filter, and cloud-based antivirus and SSL inspection enabled (as part of an active Advanced Threat Protection subscription), based on BreakingPoint Realworld-IPS-Enterprise-Traffic-Mix, bidirectional across multiple ports.
- f Depending on feature set; for more detailed information on sizing, please use the free sizing calculator on [Barracuda Campus](#).
- g MTBF according to common usage. High load on SSD and extreme environmental conditions might reduce MTBF.

Errors and omissions excepted. Specifications subject to change without notice.



# CloudGen Firewall F800C.CCF

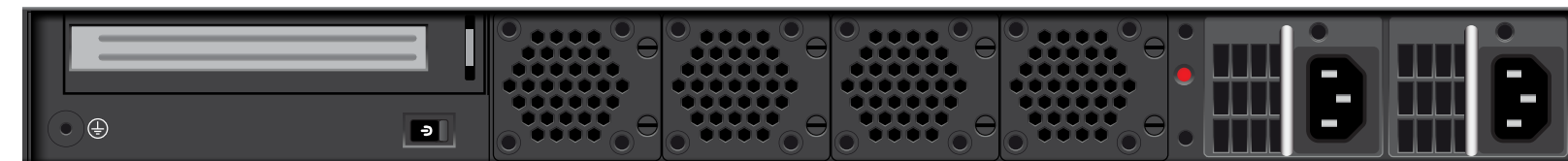
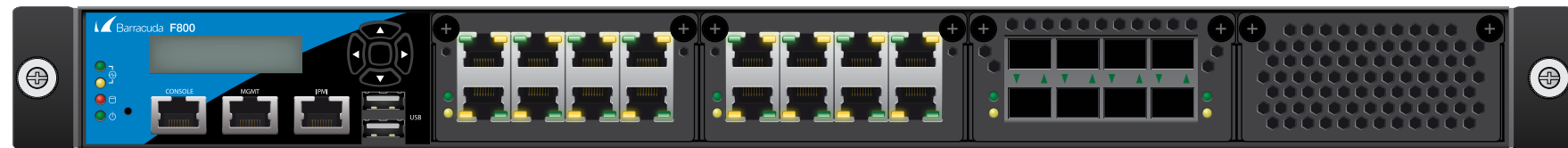

INTERFACES *	
Copper ethernet NICs (1 GbE)	16x
SFP fiber NICs (1 GbE)	8x
USB 2.0	2x
Serial / console	1x RJ45
PERFORMANCE [AS OF FIRMWARE RELEASE 8.3.X]	
Firewall throughput [Gbps] <sup>[a]</sup>	30
SD-WAN throughput [AES-128, TINA std hash, Gbps] <sup>[b]</sup>	7.5
SD-WAN throughput [AES-256, TINA std hash, Gbps] <sup>[b]</sup>	6.7
SD-WAN throughput [AES-256, SHA256, Gbps] <sup>[b]</sup>	5.3
SD-WAN throughput [AES-256, MD5, Gbps] <sup>[b]</sup>	6.5
SD-WAN throughput [AES-256, GCM, Gbps] <sup>[b]</sup>	6.5
IPS throughput [Gbps] <sup>[c]</sup>	8.3
NGFW throughput [Gbps] <sup>[d]</sup>	7.7
Threat protection throughput [Gbps] <sup>[e]</sup>	7.6
Concurrent sessions	2,500,000
New sessions/s	180,000
Recommended number of concurrent users <sup>[f]</sup>	4,000-6,000
MEMORY	
RAM [GB]	24
MASS STORAGE	
Type	SSD
Size [(GB) or better]	430
SSD MTBF [hours]	1,200,000
SIZE, WEIGHT, DIMENSIONS	
Weight appliance [lbs] / [kg]	26.0 / 12.0
Appliance size: width x depth x height [in]	17.2 x 22.4 x 1.7
Appliance size: width x depth x height [mm]	440 x 570 x 44
Weight carton with appliance [lbs] / [kg]	44.0 / 20.0
Carton size: width x depth x height [in]	23.0 x 30.5 x 9.0
Carton size: width x depth x height [mm]	585 x 775 x 229
Form factor	1U rack mount
HARDWARE	
Display	✓
Cooling	Fan
ENVIRONMENTAL	
Noise emission [db/A]	< 75
Operating temperature [°F] / [°C]	+32 to +104 / 0 to +40
Storage temperature [°F] / [°C]	-4 to +167 / -20 to +75
Operating humidity (non-condensing)	10% to 85%

MTBF [SYSTEM]	
MTBF [yrs.] <sup>[g]</sup>	> 4
POWER AND EFFICIENCY	
Power supply	Dual hot swap
Power supply type	Internal
Power type [AC/DC]	AC
Input ratings [Volts]	100-240
Input frequency [Hz]	50-60
Auto sense	✓
Max. power draw [W]	500
Max. power draw @ 120V [Amps]	8
Max. power draw @ 230V [Amps]	4
Max. heat dissipation [W]	~ 400
Max. heat dissipation [BTU]	~ 1,366
Energy efficiency (average)	88%
CERTIFICATIONS AND COMPLIANCE (ALSO SEE PAGE 104 FF)	
CE emissions	✓
CE electrical safety	✓
FCC emissions	✓
ROHS compliant	✓
PACKAGING CONTENT	
Appliance	✓
Straight network cable	✓
Direct power-to-wall outlet	✓
USB flash drive for recovery and installation	✓
Quick start guide	✓
2x Barracuda L-shape rack mount bracket	✓
Barracuda rail kit	✓

\* Available sub models can be re-configured in the field. However, the re-configuration of network modules can be only applied to meet with available sub models. E.g., you may reconfigure from model CCC to CCE or CCF but not to a model CFE as such a sub model is not available for F800. Network modules may be replaced in case of failure. Spare parts for redundant power supply can be ordered separately.

All performance values are measured under optimized conditions and are to be considered as „up to“ values and may vary depending on system configuration and infrastructure:

- a Firewall throughput measured with large UDP packets (MTU1500), bi-directional across multiple ports.
- b SD-WAN throughput is based on 1415 Byte UDP packets, bidirectional using BreakingPoint traffic generator.
- c IPS throughput is measured with large UDP packets (MTU1500) and across multiple ports.
- d NGFW throughput is measured with IPS, application control, and web filter enabled, based on BreakingPoint Realworld-IPS-Enterprise-Traffic-Mix, bidirectional across multiple ports.
- e Threat protection throughput is measured with IPS, application control, web filter, and cloud-based antivirus and SSL inspection enabled (as part of an active Advanced Threat Protection subscription), based on BreakingPoint Realworld-IPS-Enterprise-Traffic-Mix, bidirectional across multiple ports.
- f Depending on feature set; for more detailed information on sizing, please use the free sizing calculator on [Barracuda Campus](#).
- g MTBF according to common usage. High load on SSD and extreme environmental conditions might reduce MTBF.

Errors and omissions excepted. Specifications subject to change without notice.



# CloudGen Firewall F800C.CCE

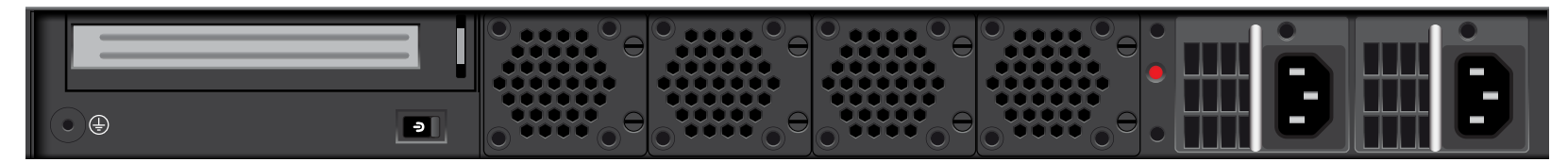
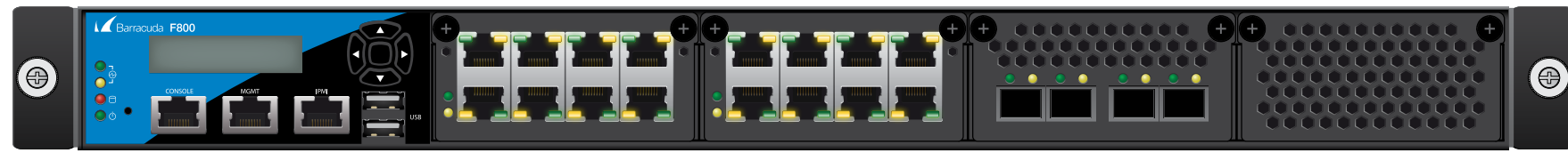

INTERFACES *	
Copper ethernet NICs (1 GbE)	16x
SFP+ fiber NICs (10 GbE)	4x
USB 2.0	2x
Serial / console	1x RJ45
PERFORMANCE [AS OF FIRMWARE RELEASE 8.3.X]	
Firewall throughput [Gbps] <sup>[a]</sup>	30
SD-WAN throughput [AES-128, TINA std hash, Gbps] <sup>[b]</sup>	7.5
SD-WAN throughput [AES-256, TINA std hash, Gbps] <sup>[b]</sup>	6.7
SD-WAN throughput [AES-256, SHA256, Gbps] <sup>[b]</sup>	5.3
SD-WAN throughput [AES-256, MD5, Gbps] <sup>[b]</sup>	6.5
SD-WAN throughput [AES-256, GCM, Gbps] <sup>[b]</sup>	6.5
IPS throughput [Gbps] <sup>[c]</sup>	8.3
NGFW throughput [Gbps] <sup>[d]</sup>	7.7
Threat protection throughput [Gbps] <sup>[e]</sup>	7.6
Concurrent sessions	2,500,000
New sessions/s	180,000
Recommended number of concurrent users <sup>[f]</sup>	4,000-6,000
MEMORY	
RAM [(GB) or better]	24
MASS STORAGE	
Type	SSD
Size [(GB) or better]	430
SSD MTBF [hours]	1,200,000
SIZE, WEIGHT, DIMENSIONS	
Weight appliance [lbs] / [kg]	26.0 / 12.0
Appliance size: width x depth x height [in]	17.2 x 22.4 x 1.7
Appliance size: width x depth x height [mm]	440 x 570 x 44
Weight carton with appliance [lbs] / [kg]	44.0 / 20.0
Carton size: width x depth x height [in]	23.0 x 30.5 x 9.0
Carton size: width x depth x height [mm]	585 x 775 x 229
Form factor	1U rack mount
HARDWARE	
Display	✓
Cooling	Fan
ENVIRONMENTAL	
Noise emission [db/A]	< 75
Operating temperature [°F] / [°C]	+32 to +104 / 0 to +40
Storage temperature [°F] / [°C]	-4 to +167 / -20 to +75
Operating humidity (non-condensing)	10% to 85%

MTBF [SYSTEM]	
MTBF [yrs.] <sup>[g]</sup>	> 4
POWER AND EFFICIENCY	
Power supply	Dual hot swap
Power supply type	Internal
Power type [AC/DC]	AC
Input ratings [Volts]	100-240
Input frequency [Hz]	50-60
Auto sense	✓
Max. power draw [W]	500
Max. power draw @ 120V [Amps]	8
Max. power draw @ 230V [Amps]	4
Max. heat dissipation [W]	~ 400
Max. heat dissipation [BTU]	~ 1,366
Energy efficiency (average)	88%
CERTIFICATIONS AND COMPLIANCE (ALSO SEE PAGE 104 FF)	
CE emissions	✓
CE electrical safety	✓
FCC emissions	✓
ROHS compliant	✓
PACKAGING CONTENT	
Appliance	✓
Straight network cable	✓
Direct power-to-wall outlet	✓
USB flash drive for recovery and installation	✓
Quick start guide	✓
2x Barracuda L-shape rack mount bracket	✓
Barracuda rail kit	✓

\* Available sub models can be re-configured in the field. However, the re-configuration of network modules can be only applied to meet with available sub models. E.g., you may reconfigure from model CCC to CCE or CCF but not to a model CFE as such a sub model is not available for F800. Network modules may be replaced in case of failure. Spare parts for redundant power supply can be ordered separately.

All performance values are measured under optimized conditions and are to be considered as „up to“ values and may vary depending on system configuration and infrastructure:

- a Firewall throughput measured with large UDP packets (MTU1500), bi-directional across multiple ports.
- b SD-WAN throughput is based on 1415 Byte UDP packets, bidirectional using BreakingPoint traffic generator.
- c IPS throughput is measured with large UDP packets (MTU1500) and across multiple ports.
- d NGFW throughput is measured with IPS, application control, and web filter enabled, based on BreakingPoint Realworld-IPS-Enterprise-Traffic-Mix, bidirectional across multiple ports.
- e Threat protection throughput is measured with IPS, application control, web filter, and cloud-based antivirus and SSL inspection enabled (as part of an active Advanced Threat Protection subscription), based on BreakingPoint Realworld-IPS-Enterprise-Traffic-Mix, bidirectional across multiple ports.
- f Depending on feature set; for more detailed information on sizing, please use the free sizing calculator on [Barracuda Campus](#).
- g MTBF according to common usage. High load on SSD and extreme environmental conditions might reduce MTBF.

Errors and omissions excepted. Specifications subject to change without notice.



# CloudGen Firewall F900B.CCC

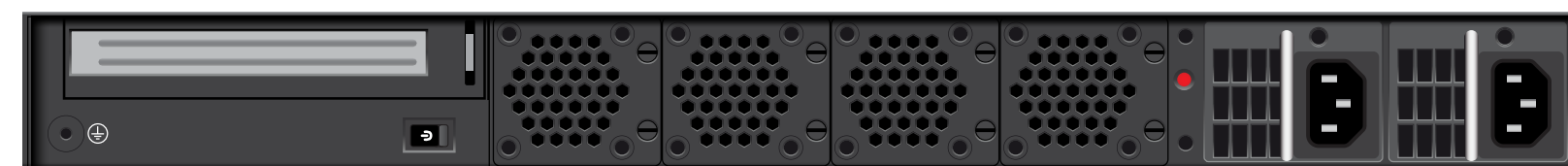
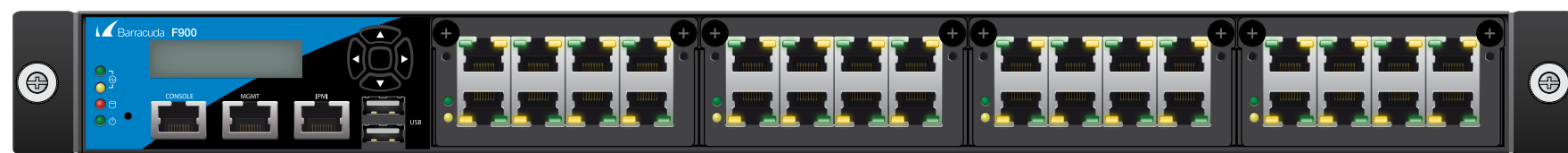

INTERFACES *	
Copper ethernet NICs (1 GbE)	32x
USB 2.0	2x
IPMI	1x RJ45
Serial / console	1x RJ45
Management	1x RJ45
PERFORMANCE [AS OF FIRMWARE RELEASE 8.3.X]	
Firewall throughput [Gbps] <sup>[a]</sup>	35
SD-WAN throughput [AES-128, TINA std hash, Gbps] <sup>[b]</sup>	9.3
SD-WAN throughput [AES-256, TINA std hash, Gbps] <sup>[b]</sup>	7.7
SD-WAN throughput [AES-256, SHA256, Gbps] <sup>[b]</sup>	4.5
SD-WAN throughput [AES-256, MD5, Gbps] <sup>[b]</sup>	7.5
SD-WAN throughput [AES-256, GCM, Gbps] <sup>[b]</sup>	7.5
IPS throughput [Gbps] <sup>[c]</sup>	11.3
NGFW throughput [Gbps] <sup>[d]</sup>	8.0
Threat protection throughput [Gbps] <sup>[e]</sup>	8.0
Concurrent sessions	4,000,000
New sessions/s	190,000
Recommended number of concurrent users <sup>[f]</sup>	6,000-9,000
MEMORY	
RAM ([GB] or better)	32
MASS STORAGE	
Type	SSD
Size ([GB] or better)	430
SSD MTBF [hours]	1,200,000
SIZE, WEIGHT, DIMENSIONS	
Weight appliance [lbs] / [kg]	26.0 / 12.0
Appliance size: width x depth x height [in]	17.2 x 22.4 x 1.7
Appliance size: width x depth x height [mm]	440 x 570 x 44
Weight carton with appliance [lbs] / [kg]	44.0 / 20.0
Carton size: width x depth x height [in]	23.0 x 30.5 x 9.0
Carton size: width x depth x height [mm]	585 x 775 x 229
Form factor	1U rack mount
HARDWARE	
Display	✓
Cooling	Fan
ENVIRONMENTAL	
Noise emission [db/A]	< 75
Operating temperature [°F] / [°C]	+32 to +104 / 0 to +40
Storage temperature [°F] / [°C]	-4 to +167 / -20 to +75
Operating humidity (non-condensing)	10% to 85%

MTBF [SYSTEM]	
MTBF [yrs.] <sup>[g]</sup>	> 4
POWER AND EFFICIENCY	
Power supply	Dual hot swap
Power supply type	Internal
Power type [AC/DC]	AC
Input ratings [Volts]	100-240
Input frequency [Hz]	50-60
Auto sense	✓
Max. power draw [W]	500
Max. power draw @ 120V [Amps]	8
Max. power draw @ 230V [Amps]	4
Max. heat dissipation [W]	~ 400
Max. heat dissipation [BTU]	~ 1,366
Energy efficiency (average)	88%
CERTIFICATIONS AND COMPLIANCE (ALSO SEE PAGE 104 FF)	
CE emissions	✓
CE electrical safety	✓
FCC emissions	✓
ROHS compliant	✓
PACKAGING CONTENT	
Appliance	✓
Straight network cable	✓
Direct power-to-wall outlet	✓
USB flash drive for recovery and installation	✓
Quick start guide	✓
2x Barracuda L-shape rack mount bracket	✓
Barracuda rail kit	✓

\* Available sub models can be re-configured in the field. However, the re-configuration of network modules can be only applied to meet with available sub models. E.g., you may reconfigure from model CCC to CCE or CFEQ but not to a model CCF as such a sub model is not available for F900. Network modules may be replaced in case of failure. Spare parts for redundant power supply can be ordered separately.

All performance values are measured under optimized conditions and are to be considered as „up to“ values and may vary depending on system configuration and infrastructure:

- a Firewall throughput measured with large UDP packets (MTU1500), bi-directional across multiple ports.
- b SD-WAN throughput is based on 1415 Byte UDP packets, bidirectional using BreakingPoint traffic generator.
- c IPS throughput is measured with large UDP packets (MTU1500) and across multiple ports.
- d NGFW throughput is measured with IPS, application control, and web filter enabled, based on BreakingPoint Realworld-IPS-Enterprise-Traffic-Mix, bidirectional across multiple ports.
- e Threat protection throughput is measured with IPS, application control, web filter, and cloud-based antivirus and SSL inspection enabled (as part of an active Advanced Threat Protection subscription), based on BreakingPoint Realworld-IPS-Enterprise-Traffic-Mix, bidirectional across multiple ports.
- f Depending on feature set; for more detailed information on sizing, please use the free sizing calculator on [Barracuda Campus](#).
- g MTBF according to common usage. High load on SSD and extreme environmental conditions might reduce MTBF.

Errors and omissions excepted. Specifications subject to change without notice.



# CloudGen Firewall F900B.CCE

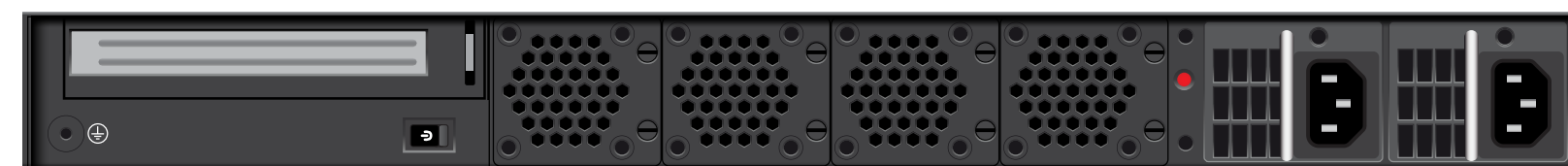
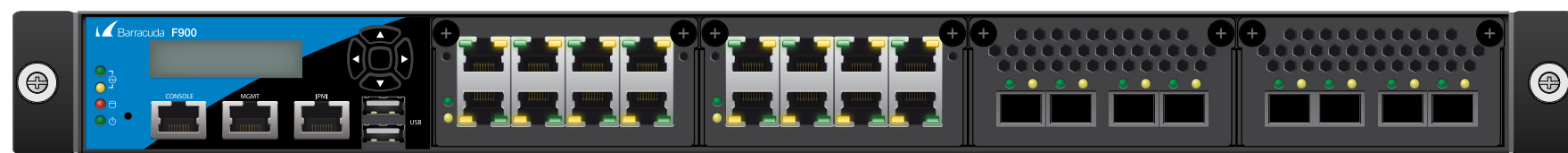

INTERFACES *	
Copper ethernet NICs (1 GbE)	16x
SFP+ fiber NICs (10 GbE)	8x
USB 2.0	2x
IPMI	1x RJ45
Serial / console	1x RJ45
Management	1x RJ45
PERFORMANCE [AS OF FIRMWARE RELEASE 8.3.X]	
Firewall throughput [Gbps] <sup>[a]</sup>	35
SD-WAN throughput [AES-128, TINA std hash, Gbps] <sup>[b]</sup>	9.3
SD-WAN throughput [AES-256, TINA std hash, Gbps] <sup>[b]</sup>	7.7
SD-WAN throughput [AES-256, SHA256, Gbps] <sup>[b]</sup>	4.5
SD-WAN throughput [AES-256, MD5, Gbps] <sup>[b]</sup>	7.5
SD-WAN throughput [AES-256, GCM, Gbps] <sup>[b]</sup>	7.5
IPS throughput [Gbps] <sup>[c]</sup>	11.3
NGFW throughput [Gbps] <sup>[d]</sup>	8.0
Threat protection throughput [Gbps] <sup>[e]</sup>	8.0
Concurrent sessions	4,000,000
New sessions/s	190,000
Recommended number of concurrent users <sup>[f]</sup>	6,000-9,000
MEMORY	
RAM ([GB] or better)	32
MASS STORAGE	
Type	SSD
Size ([GB] or better)	430
SSD MTBF [hours]	1,200,000
SIZE, WEIGHT, DIMENSIONS	
Weight appliance [lbs] / [kg]	26.0 / 12.0
Appliance size: width x depth x height [in]	17.2 x 22.4 x 1.7
Appliance size: width x depth x height [mm]	440 x 570 x 44
Weight carton with appliance [lbs] / [kg]	44.0 / 20.0
Carton size: width x depth x height [in]	23.0 x 30.5 x 9.0
Carton size: width x depth x height [mm]	585 x 775 x 229
Form factor	1U rack mount
HARDWARE	
Display	✓
Cooling	Fan
ENVIRONMENTAL	
Noise emission [db/A]	< 75
Operating temperature [°F] / [°C]	+32 to +104 / 0 to +40
Storage temperature [°F] / [°C]	-4 to +167 / -20 to +75
Operating humidity (non-condensing)	10% to 85%

MTBF [SYSTEM]	
MTBF [yrs.] <sup>[g]</sup>	> 4
POWER AND EFFICIENCY	
Power supply	Dual hot swap
Power supply type	Internal
Power type [AC/DC]	AC
Input ratings [Volts]	100-240
Input frequency [Hz]	50-60
Auto sense	✓
Max. power draw [W]	500
Max. power draw @ 120V [Amps]	8
Max. power draw @ 230V [Amps]	4
Max. heat dissipation [W]	~ 400
Max. heat dissipation [BTU]	~ 1,366
Energy efficiency (average)	88%
CERTIFICATIONS AND COMPLIANCE (ALSO SEE PAGE 104 FF)	
CE emissions	✓
CE electrical safety	✓
FCC emissions	✓
ROHS compliant	✓
PACKAGING CONTENT	
Appliance	✓
Straight network cable	✓
Direct power-to-wall outlet	✓
USB flash drive for recovery and installation	✓
Quick start guide	✓
2x Barracuda L-shape rack mount bracket	✓
Barracuda rail kit	✓

\* Available sub models can be re-configured in the field. However, the re-configuration of network modules can be only applied to meet with available sub models. E.g., you may reconfigure from model CCC to CCE or CFEQ but not to a model CCF as such a sub model is not available for F900. Network modules may be replaced in case of failure. Spare parts for redundant power supply can be ordered separately.

All performance values are measured under optimized conditions and are to be considered as „up to“ values and may vary depending on system configuration and infrastructure:

- a Firewall throughput measured with large UDP packets (MTU1500), bi-directional across multiple ports.
- b SD-WAN throughput is based on 1415 Byte UDP packets, bidirectional using BreakingPoint traffic generator.
- c IPS throughput is measured with large UDP packets (MTU1500) and across multiple ports.
- d NGFW throughput is measured with IPS, application control, and web filter enabled, based on BreakingPoint Realworld-IPS-Enterprise-Traffic-Mix, bidirectional across multiple ports.
- e Threat protection throughput is measured with IPS, application control, web filter, and cloud-based antivirus and SSL inspection enabled (as part of an active Advanced Threat Protection subscription), based on BreakingPoint Realworld-IPS-Enterprise-Traffic-Mix, bidirectional across multiple ports.
- f Depending on feature set; for more detailed information on sizing, please use the free sizing calculator on [Barracuda Campus](#).
- g MTBF according to common usage. High load on SSD and extreme environmental conditions might reduce MTBF.

Errors and omissions excepted. Specifications subject to change without notice.



# CloudGen Firewall F900B.CFE

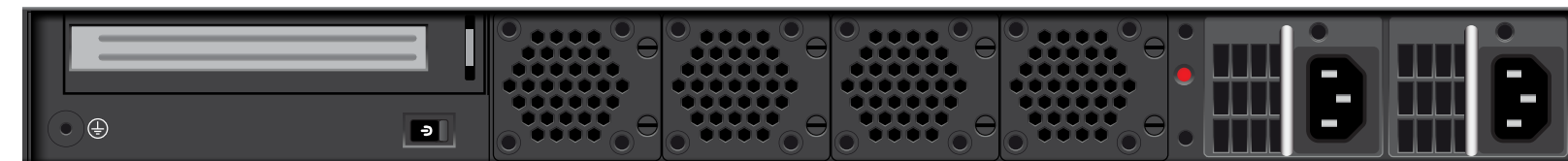
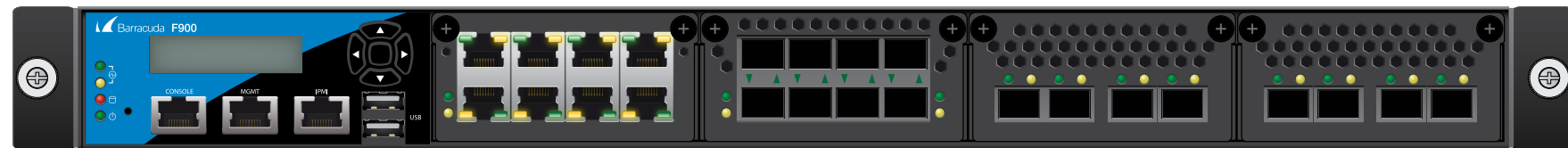

INTERFACES *	
Copper ethernet NICs (1 GbE)	8x
SFP fiber NICs (1 GbE)	8x
SFP+ fiber NICs (10 GbE)	8x
USB 2.0	2x
IPMI	1x RJ45
Serial / console	1x RJ45
Management	1x RJ45
PERFORMANCE [AS OF FIRMWARE RELEASE 8.3.X]	
Firewall throughput [Gbps] <sup>[a]</sup>	35
SD-WAN throughput [AES-128, TINA std hash, Gbps] <sup>[b]</sup>	9.3
SD-WAN throughput [AES-256, TINA std hash, Gbps] <sup>[b]</sup>	7.7
SD-WAN throughput [AES-256, SHA256, Gbps] <sup>[b]</sup>	4.5
SD-WAN throughput [AES-256, MD5, Gbps] <sup>[b]</sup>	7.5
SD-WAN throughput [AES-256, GCM, Gbps] <sup>[b]</sup>	7.5
IPS throughput [Gbps] <sup>[c]</sup>	11.3
NGFW throughput [Gbps] <sup>[d]</sup>	8.0
Threat protection throughput [Gbps] <sup>[e]</sup>	8.0
Concurrent sessions	4,000,000
New sessions/s	190,000
Recommended number of concurrent users <sup>[f]</sup>	6,000-9,000
MEMORY	
RAM ([GB] or better)	32
MASS STORAGE	
Type	SSD
Size ([GB] or better)	430
SSD MTBF [hours]	1,200,000
SIZE, WEIGHT, DIMENSIONS	
Weight appliance [lbs] / [kg]	26.0 / 12.0
Appliance size: width x depth x height [in]	17.2 x 22.4 x 1.7
Appliance size: width x depth x height [mm]	440 x 570 x 44
Weight carton with appliance [lbs] / [kg]	44.0 / 20.0
Carton size: width x depth x height [in]	23.0 x 30.5 x 9.0
Carton size: width x depth x height [mm]	585 x 775 x 229
Form factor	1U rack mount
HARDWARE	
Display	✓
Cooling	Fan
ENVIRONMENTAL	
Noise emission [db/A]	< 75
Operating temperature [°F] / [°C]	+32 to +104 / 0 to +40
Storage temperature [°F] / [°C]	-4 to +167 / -20 to +75
Operating humidity (non-condensing)	10% to 85%

MTBF [SYSTEM]	
MTBF [yrs.] <sup>[g]</sup>	> 4
POWER AND EFFICIENCY	
Power supply	Dual hot swap
Power supply type	Internal
Power type [AC/DC]	AC
Input ratings [Volts]	100-240
Input frequency [Hz]	50-60
Auto sense	✓
Max. power draw [W]	500
Max. power draw @ 120V [Amps]	8
Max. power draw @ 230V [Amps]	4
Max. heat dissipation [W]	~ 400
Max. heat dissipation [BTU]	~ 1,366
Energy efficiency (average)	88%
CERTIFICATIONS AND COMPLIANCE (ALSO SEE PAGE 104 FF)	
CE emissions	✓
CE electrical safety	✓
FCC emissions	✓
ROHS compliant	✓
PACKAGING CONTENT	
Appliance	✓
Straight network cable	✓
Direct power-to-wall outlet	✓
USB flash drive for recovery and installation	✓
Quick start guide	✓
2x Barracuda L-shape rack mount bracket	✓
Barracuda rail kit	✓

\* Available sub models can be re-configured in the field. However, the re-configuration of network modules can be only applied to meet with available sub models. E.g., you may reconfigure from model CCC to CCE or CFEQ but not to a model CCF as such a sub model is not available for F900. Network modules may be replaced in case of failure. Spare parts for redundant power supply can be ordered separately.

All performance values are measured under optimized conditions and are to be considered as „up to“ values and may vary depending on system configuration and infrastructure:

- a Firewall throughput measured with large UDP packets (MTU1500), bi-directional across multiple ports.
- b SD-WAN throughput is based on 1415 Byte UDP packets, bidirectional using BreakingPoint traffic generator.
- c IPS throughput is measured with large UDP packets (MTU1500) and across multiple ports.
- d NGFW throughput is measured with IPS, application control, and web filter enabled, based on BreakingPoint Realworld-IPS-Enterprise-Traffic-Mix, bidirectional across multiple ports.
- e Threat protection throughput is measured with IPS, application control, web filter, and cloud-based antivirus and SSL inspection enabled (as part of an active Advanced Threat Protection subscription), based on BreakingPoint Realworld-IPS-Enterprise-Traffic-Mix, bidirectional across multiple ports.
- f Depending on feature set; for more detailed information on sizing, please use the free sizing calculator on [Barracuda Campus](#).
- g MTBF according to common usage. High load on SSD and extreme environmental conditions might reduce MTBF.

Errors and omissions excepted. Specifications subject to change without notice.



# CloudGen Firewall F900B.CFEQ

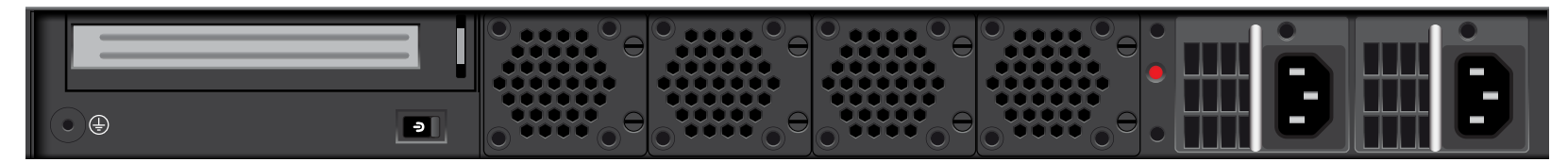
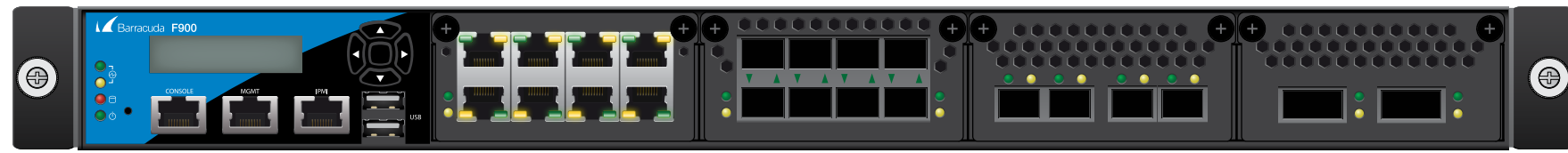

INTERFACES *	
Copper ethernet NICs (1 GbE)	8x
SFP fiber NICs (1 GbE)	8x
SFP+ fiber NICs (10 GbE)	4x
QSFP+ fiber NICs (40 GbE)	2x
USB 2.0	2x
IPMI	1x RJ45
Serial / console	1x RJ45
Management	1x RJ45
PERFORMANCE [AS OF FIRMWARE RELEASE 8.3.X]	
Firewall throughput [Gbps] <sup>[a]</sup>	45
SD-WAN throughput [AES-128, TINA std hash, Gbps] <sup>[b]</sup>	13.5
SD-WAN throughput [AES-256, TINA std hash, Gbps] <sup>[b]</sup>	12
SD-WAN throughput [AES-256, SHA256, Gbps] <sup>[b]</sup>	4.5
SD-WAN throughput [AES-256, MD5, Gbps] <sup>[b]</sup>	10
SD-WAN throughput [AES-256, GCM, Gbps] <sup>[b]</sup>	4.5
IPS throughput [Gbps] <sup>[c]</sup>	13
NGFW throughput [Gbps] <sup>[d]</sup>	12
Threat protection throughput [Gbps] <sup>[e]</sup>	11.5
Concurrent sessions	4,000,000
New sessions/s	190,000
Recommended number of concurrent users <sup>[f]</sup>	7,000-15,000
MEMORY	
RAM ([GB] or better)	32
MASS STORAGE	
Type	SSD
Size ([GB] or better)	430
SSD MTBF [hours]	1,200,000
SIZE, WEIGHT, DIMENSIONS	
Weight appliance [lbs] / [kg]	26.0 / 12.0
Appliance size: width x depth x height [in]	17.2 x 22.4 x 1.7
Appliance size: width x depth x height [mm]	440 x 570 x 44
Weight carton with appliance [lbs] / [kg]	44.0 / 20.0
Carton size: width x depth x height [in]	23.0 x 30.5 x 9.0
Carton size: width x depth x height [mm]	585 x 775 x 229
Form factor	1U rack mount
HARDWARE	
Display	✓
Cooling	Fan
ENVIRONMENTAL	
Noise emission [db/A]	< 75
Operating temperature [°F] / [°C]	+32 to +104 / 0 to +40
Storage temperature [°F] / [°C]	-4 to +167 / -20 to +75
Operating humidity (non-condensing)	10% to 85%

MTBF [SYSTEM]	
MTBF [yrs.] <sup>[g]</sup>	> 4
POWER AND EFFICIENCY	
Power supply	Dual hot swap
Power supply type	Internal
Power type [AC/DC]	AC
Input ratings [Volts]	100-240
Input frequency [Hz]	50-60
Auto sense	✓
Max. power draw [W]	500
Max. power draw @ 120V [Amps]	8
Max. power draw @ 230V [Amps]	4
Max. heat dissipation [W]	~ 400
Max. heat dissipation [BTU]	~ 1,366
Energy efficiency (average)	88%
CERTIFICATIONS AND COMPLIANCE (ALSO SEE PAGE 104 FF)	
CE emissions	✓
CE electrical safety	✓
FCC emissions	✓
ROHS compliant	✓
PACKAGING CONTENT	
Appliance	✓
Straight network cable	✓
Direct power-to-wall outlet	✓
USB flash drive for recovery and installation	✓
Quick start guide	✓
2x Barracuda L-shape rack mount bracket	✓
Barracuda rail kit	✓

\* Available sub models can be re-configured in the field. However, the re-configuration of network modules can be only applied to meet with available sub models. E.g., you may reconfigure from model CCC to CCE or CFEQ but not to a model CCF as such a sub model is not available for F900. Network modules may be replaced in case of failure. Spare parts for redundant power supply can be ordered separately.

All performance values are measured under optimized conditions and are to be considered as „up to“ values and may vary depending on system configuration and infrastructure:

- a Firewall throughput measured with large UDP packets (MTU1500), bi-directional across multiple ports.
- b SD-WAN throughput is based on 1415 Byte UDP packets, bidirectional using BreakingPoint traffic generator.
- c IPS throughput is measured with large UDP packets (MTU1500) and across multiple ports.
- d NGFW throughput is measured with IPS, application control, and web filter enabled, based on BreakingPoint Realworld-IPS-Enterprise-Traffic-Mix, bidirectional across multiple ports.
- e Threat protection throughput is measured with IPS, application control, web filter, and cloud-based antivirus and SSL inspection enabled (as part of an active Advanced Threat Protection subscription), based on BreakingPoint Realworld-IPS-Enterprise-Traffic-Mix, bidirectional across multiple ports.
- f Depending on feature set; for more detailed information on sizing, please use the free sizing calculator on [Barracuda Campus](#).
- g MTBF according to common usage. High load on SSD and extreme environmental conditions might reduce MTBF.

Errors and omissions excepted. Specifications subject to change without notice.



# CloudGen Firewall F1000B.CEO

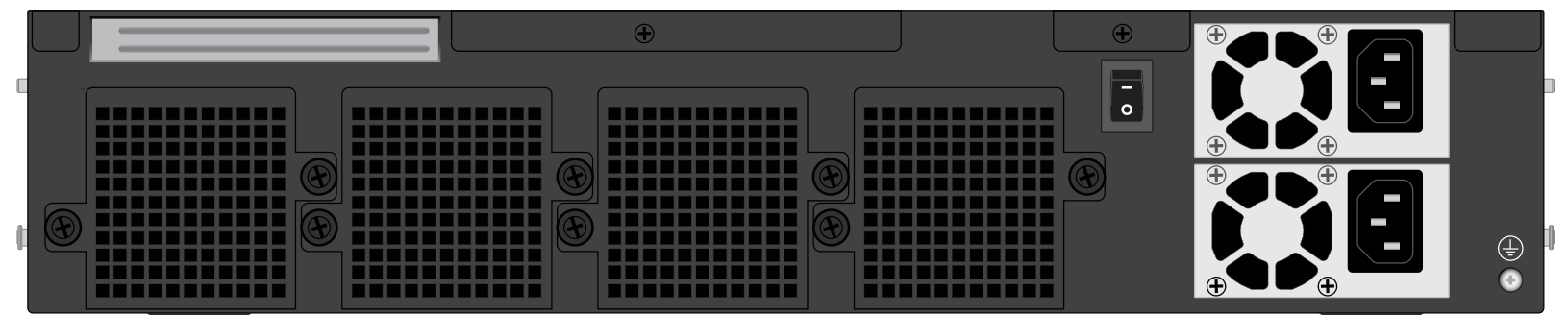
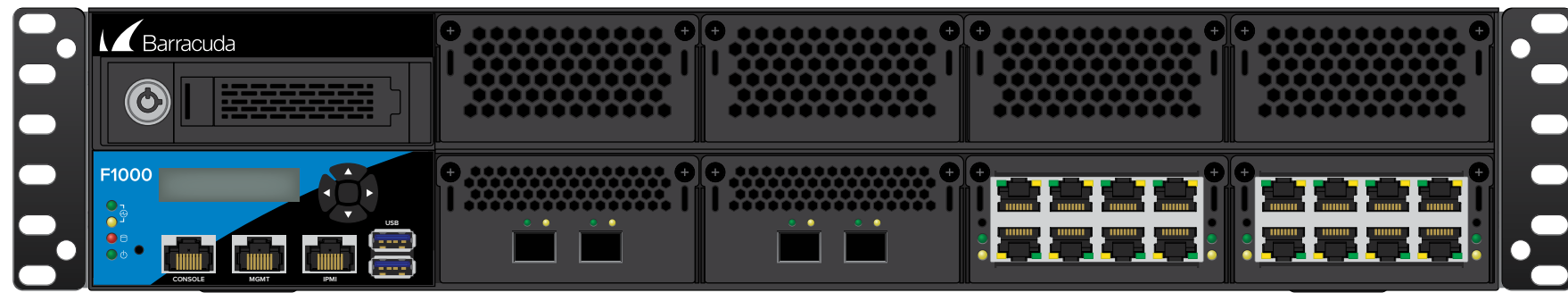

INTERFACES *	
Copper ethernet NICs (1 GbE)	16x
SFP+ fiber NICs (10 GbE)	4x
USB 3.0	2x
IPMI	1x RJ45
Management	1x RJ45
Serial / console	1x RJ45
PERFORMANCE [AS OF FIRMWARE RELEASE 8.3.X]	
Firewall throughput [Gbps] <sup>[a]</sup>	52
SD-WAN throughput [AES-128, TINA std hash, Gbps] <sup>[b]</sup>	15.8
SD-WAN throughput [AES-256, TINA std hash, Gbps] <sup>[b]</sup>	14
SD-WAN throughput [AES-256, SHA256, Gbps] <sup>[b]</sup>	7.4
SD-WAN throughput [AES-256, MD5, Gbps] <sup>[b]</sup>	10.4
SD-WAN throughput [AES-256, GCM, Gbps] <sup>[b]</sup>	7.3
IPS throughput [Gbps] <sup>[c]</sup>	16
NGFW throughput [Gbps] <sup>[d]</sup>	14.8
Threat protection throughput [Gbps] <sup>[e]</sup>	13.5
Concurrent sessions	10,000,000
New sessions/s	250,000
Recommended number of concurrent users <sup>[f]</sup>	7,000-15,000
MEMORY	
RAM [GB]	128
MASS STORAGE	
Type	SSD
System disk size ([GB] or better)	550
System disk MTBF [hours]	1,200,000
Optional swappable disk size ([GB])	550
Optional swappable disk MTBF [hours]	1,200,000
SIZE, WEIGHT, DIMENSIONS	
Weight appliance [lbs] / [kg]	55.1 / 25.0
Appliance size: width x depth x height [in]	17.3 x 27.9 x 3.4
Appliance size: width x depth x height [mm]	440 x 710 x 88
Weight carton with appliance [lbs] / [kg]	61.7 / 28.0
Carton size: width x depth x height [in]	23.2 x 34.3 x 11.4
Carton size: width x depth x height [mm]	590 x 870 x 290
Form factor	2U rack mount
HARDWARE	
Display	✓
Cooling	Fan, hot swap
ENVIRONMENTAL	
Noise emission [db/A]	n/a
Operating temperature [°F] / [°C]	+32 to +104 / 0 to +40
Storage temperature [°F] / [°C]	-49 to +167 / -45 to +75
Operating humidity (non-condensing)	5% to 95%

MTBF [SYSTEM]	
MTBF [yrs.] <sup>[g]</sup>	> 4
POWER AND EFFICIENCY	
Power supply	Dual hot swap
Power supply type	Internal
Power type [AC/DC]	AC
Input ratings [Volts]	100-240
Input frequency [Hz]	50-60
Auto sense	✓
Max. power draw [W]	810
Max. power draw @ 120V [Amps]	6.8
Max. power draw @ 230V [Amps]	3.5
Max. heat dissipation [W]	680
Max. heat dissipation [BTU]	2,322
Energy efficiency (average)	> 86%
CERTIFICATIONS AND COMPLIANCE (ALSO SEE PAGE 104 FF)	
CE emissions	✓
CE electrical safety	✓
FCC emissions	✓
ROHS compliant	✓
PACKAGING CONTENT	
Appliance	✓
Straight network cable	✓
External power brick and cables	✓
USB flash drive for recovery and installation	✓
Quick start guide	✓
2x Barracuda L-shape rack mount bracket	✓
Barracuda rail kit	✓

\* Available sub models can be re-configured in the field. However, the re-configuration of network modules can be only applied to meet with available sub models. E.g., you may reconfigure from model CEO to CE2 or CFE but not to a model CF2 as such a sub model is not available for F1000. Network modules may be replaced in case of failure. Spare parts for redundant power supply can be ordered separately.

All performance values are measured under optimized conditions and are to be considered as „up to“ values and may vary depending on system configuration and infrastructure:

- a Firewall throughput measured with large UDP packets (MTU1500), bi-directional across multiple ports.
- b SD-WAN throughput is based on 1415 Byte UDP packets, bidirectional using BreakingPoint traffic generator.
- c IPS throughput is measured with large UDP packets (MTU1500) and across multiple ports.
- d NGFW throughput is measured with IPS, application control, and web filter enabled, based on BreakingPoint Realworld-IPS-Enterprise-Traffic-Mix, bidirectional across multiple ports.
- e Threat protection throughput is measured with IPS, application control, web filter, and cloud-based antivirus and SSL inspection enabled (as part of an active Advanced Threat Protection subscription), based on BreakingPoint Realworld-IPS-Enterprise-Traffic-Mix, bidirectional across multiple ports.
- f Depending on feature set; for more detailed information on sizing, please use the free sizing calculator on [Barracuda Campus](#).
- g MTBF according to common usage. High load on SSD and extreme environmental conditions might reduce MTBF.

Errors and omissions excepted. Specifications subject to change without notice.



# CloudGen Firewall F1000B.CE2

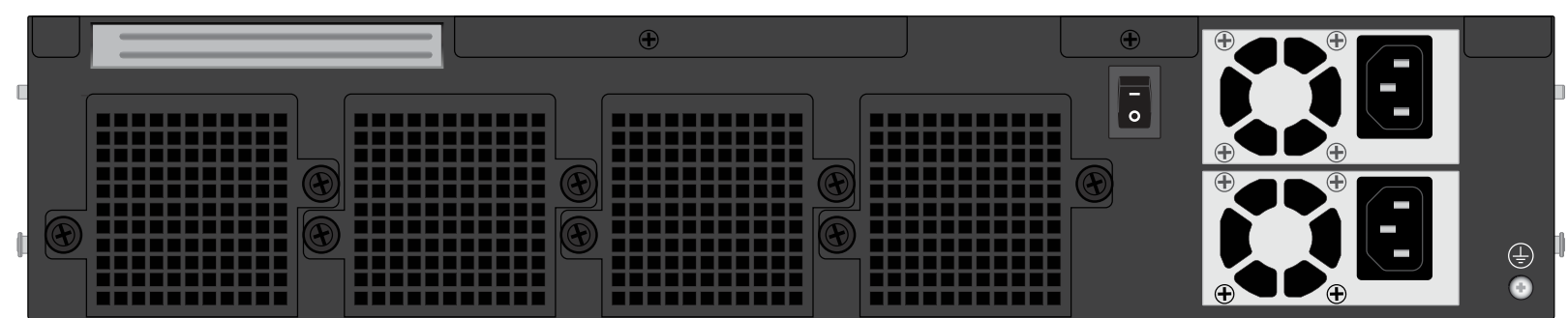
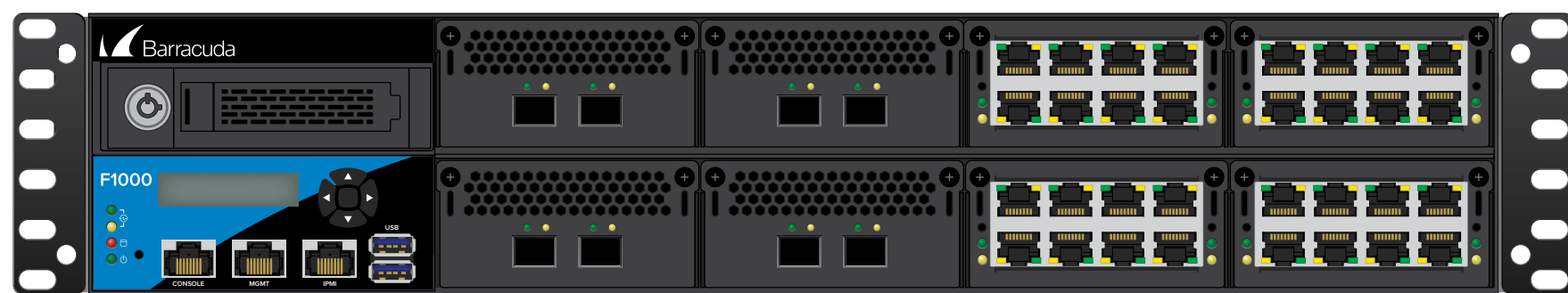

INTERFACES *	
Copper ethernet NICs (1 GbE)	32x
SFP+ fiber NICs (10 GbE)	8x
USB 3.0	2x
IPMI	1x RJ45
Management	1x RJ45
Serial / console	1x RJ45
PERFORMANCE [AS OF FIRMWARE RELEASE 8.3.X]	
Firewall throughput [Gbps] <sup>[a]</sup>	52
SD-WAN throughput [AES-128, TINA std hash, Gbps] <sup>[b]</sup>	15.8
SD-WAN throughput [AES-256, TINA std hash, Gbps] <sup>[b]</sup>	14
SD-WAN throughput [AES-256, SHA256, Gbps] <sup>[b]</sup>	7.4
SD-WAN throughput [AES-256, MD5, Gbps] <sup>[b]</sup>	10.4
SD-WAN throughput [AES-256, GCM, Gbps] <sup>[b]</sup>	7.3
IPS throughput [Gbps] <sup>[c]</sup>	16
NGFW throughput [Gbps] <sup>[d]</sup>	14.8
Threat protection throughput [Gbps] <sup>[e]</sup>	13.5
Concurrent sessions	10,000,000
New sessions/s	250,000
Recommended number of concurrent users <sup>[f]</sup>	7,000-15,000
MEMORY	
RAM [GB]	128
MASS STORAGE	
Type	SSD
System disk size ([GB] or better)	550
System disk MTBF [hours]	1,200,000
Optional swappable disk size ([GB])	550
Optional swappable disk MTBF [hours]	1,200,000
SIZE, WEIGHT, DIMENSIONS	
Weight appliance [lbs] / [kg]	55.1 / 25.0
Appliance size: width x depth x height [in]	17.3 x 27.9 x 3.4
Appliance size: width x depth x height [mm]	440 x 710 x 88
Weight carton with appliance [lbs] / [kg]	61.7 / 28.0
Carton size: width x depth x height [in]	23.2 x 34.3 x 11.4
Carton size: width x depth x height [mm]	590 x 870 x 290
Form factor	2U rack mount
HARDWARE	
Display	✓
Cooling	Fan, hot swap
ENVIRONMENTAL	
Noise emission [db/A]	n/a
Operating temperature [°F] / [°C]	+32 to +104 / 0 to +40
Storage temperature [°F] / [°C]	-49 to +167 / -45 to +75
Operating humidity (non-condensing)	5% to 95%

MTBF [SYSTEM]	
MTBF [yrs.] <sup>[g]</sup>	> 4
POWER AND EFFICIENCY	
Power supply	Dual hot swap
Power supply type	Internal
Power type [AC/DC]	AC
Input ratings [Volts]	100-240
Input frequency [Hz]	50-60
Auto sense	✓
Max. power draw [W]	810
Max. power draw @ 120V [Amps]	6.8
Max. power draw @ 230V [Amps]	3.5
Max. heat dissipation [W]	680
Max. heat dissipation [BTU]	2,322
Energy efficiency (average)	> 86%
CERTIFICATIONS AND COMPLIANCE (ALSO SEE PAGE 104 FF)	
CE emissions	✓
CE electrical safety	✓
FCC emissions	✓
ROHS compliant	✓
PACKAGING CONTENT	
Appliance	✓
Straight network cable	✓
External power brick and cables	✓
USB flash drive for recovery and installation	✓
Quick start guide	✓
2x Barracuda L-shape rack mount bracket	✓
Barracuda rail kit	✓

\* Available sub models can be re-configured in the field. However, the re-configuration of network modules can be only applied to meet with available sub models. E.g., you may reconfigure from model CE0 to CE2 or CFE but not to a model CF2 as such a sub model is not available for F1000. Network modules may be replaced in case of failure. Spare parts for redundant power supply can be ordered separately.

All performance values are measured under optimized conditions and are to be considered as „up to“ values and may vary depending on system configuration and infrastructure:

- a Firewall throughput measured with large UDP packets (MTU1500), bi-directional across multiple ports.
- b SD-WAN throughput is based on 1415 Byte UDP packets, bidirectional using BreakingPoint traffic generator.
- c IPS throughput is measured with large UDP packets (MTU1500) and across multiple ports.
- d NGFW throughput is measured with IPS, application control, and web filter enabled, based on BreakingPoint Realworld-IPS-Enterprise-Traffic-Mix, bidirectional across multiple ports.
- e Threat protection throughput is measured with IPS, application control, web filter, and cloud-based antivirus and SSL inspection enabled (as part of an active Advanced Threat Protection subscription), based on BreakingPoint Realworld-IPS-Enterprise-Traffic-Mix, bidirectional across multiple ports.
- f Depending on feature set; for more detailed information on sizing, please use the free sizing calculator on [Barracuda Campus](#).
- g MTBF according to common usage. High load on SSD and extreme environmental conditions might reduce MTBF.

Errors and omissions excepted. Specifications subject to change without notice.



# CloudGen Firewall F1000B.CFE

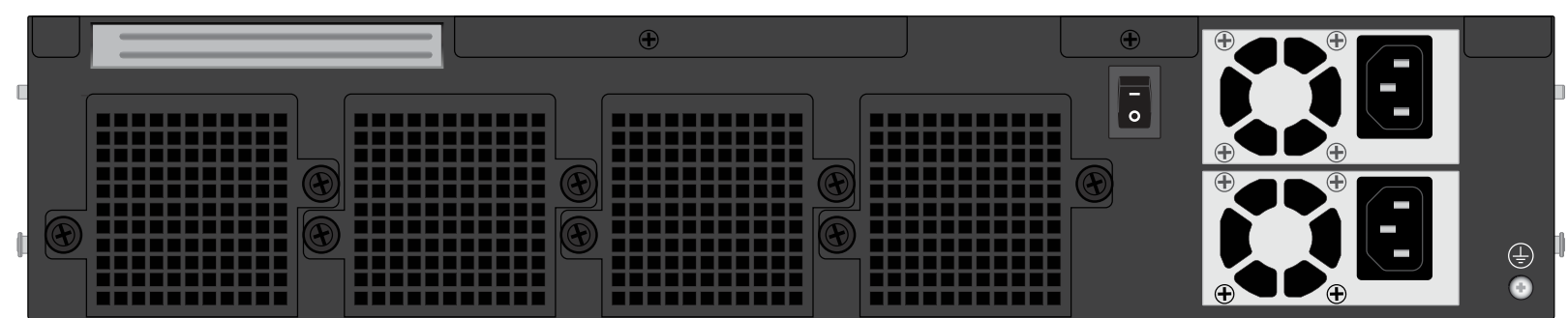
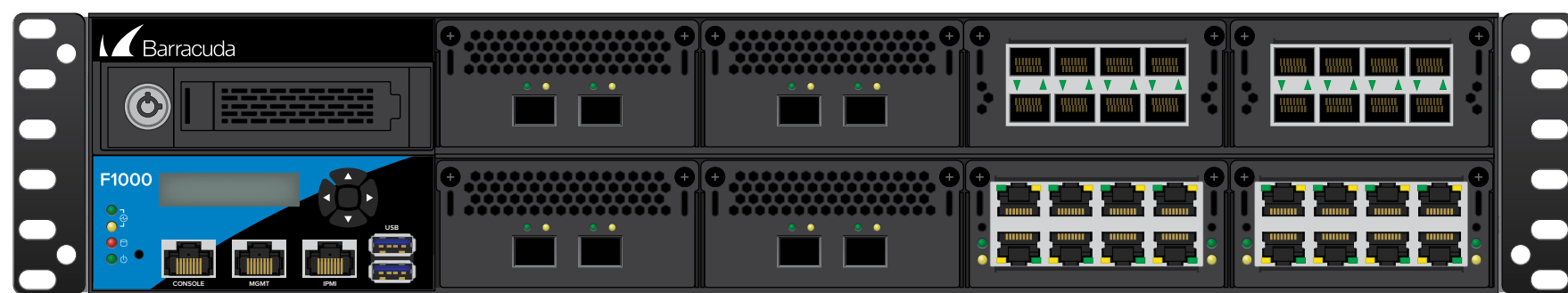

INTERFACES *	
Copper ethernet NICs (1 GbE)	16x
SFP fiber NICs (1 GbE)	16x
SFP+ fiber NICs (10 GbE)	8x
USB 3.0	2x
IPMI	1x RJ45
Management	1x RJ45
Serial / console	1x RJ45
PERFORMANCE [AS OF FIRMWARE RELEASE 8.3.X]	
Firewall throughput [Gbps] <sup>[a]</sup>	52
SD-WAN throughput [AES-128, TINA std hash, Gbps] <sup>[b]</sup>	15.8
SD-WAN throughput [AES-256, TINA std hash, Gbps] <sup>[b]</sup>	14
SD-WAN throughput [AES-256, SHA256, Gbps] <sup>[b]</sup>	7.4
SD-WAN throughput [AES-256, MD5, Gbps] <sup>[b]</sup>	10.4
SD-WAN throughput [AES-256, GCM, Gbps] <sup>[b]</sup>	7.3
IPS throughput [Gbps] <sup>[c]</sup>	16
NGFW throughput [Gbps] <sup>[d]</sup>	14.8
Threat protection throughput [Gbps] <sup>[e]</sup>	13.5
Concurrent sessions	10,000,000
New sessions/s	250,000
Recommended number of concurrent users <sup>[f]</sup>	7,000-15,000
MEMORY	
RAM [GB]	128
MASS STORAGE	
Type	SSD
System disk size [(GB) or better]	550
System disk MTBF [hours]	1,200,000
Optional swappable disk size [(GB)]	550
Optional swappable disk MTBF [hours]	1,200,000
SIZE, WEIGHT, DIMENSIONS	
Weight appliance [lbs] / [kg]	55.1 / 25.0
Appliance size: width x depth x height [in]	17.3 x 27.9 x 3.4
Appliance size: width x depth x height [mm]	440 x 710 x 88
Weight carton with appliance [lbs] / [kg]	61.7 / 28.0
Carton size: width x depth x height [in]	23.2 x 34.3 x 11.4
Carton size: width x depth x height [mm]	590 x 870 x 290
Form factor	2U rack mount
HARDWARE	
Display	✓
Cooling	Fan, hot swap
ENVIRONMENTAL	
Noise emission [db/A]	n/a
Operating temperature [°F] / [°C]	+32 to +104 / 0 to +40
Storage temperature [°F] / [°C]	-49 to +167 / -45 to +75
Operating humidity (non-condensing)	5% to 95%

MTBF [SYSTEM]	
MTBF [yrs.] <sup>[g]</sup>	> 4
POWER AND EFFICIENCY	
Power supply	Dual hot swap
Power supply type	Internal
Power type [AC/DC]	AC
Input ratings [Volts]	100-240
Input frequency [Hz]	50-60
Auto sense	✓
Max. power draw [W]	810
Max. power draw @ 120V [Amps]	6.8
Max. power draw @ 230V [Amps]	3.5
Max. heat dissipation [W]	680
Max. heat dissipation [BTU]	2,322
Energy efficiency (average)	> 86%
CERTIFICATIONS AND COMPLIANCE (ALSO SEE PAGE 104 FF)	
CE emissions	✓
CE electrical safety	✓
FCC emissions	✓
ROHS compliant	✓
PACKAGING CONTENT	
Appliance	✓
Straight network cable	✓
External power brick and cables	✓
USB flash drive for recovery and installation	✓
Quick start guide	✓
2x Barracuda L-shape rack mount bracket	✓
Barracuda rail kit	✓

\* Available sub models can be re-configured in the field. However, the re-configuration of network modules can be only applied to meet with available sub models. E.g., you may reconfigure from model CE0 to CE2 or CFE but not to a model CF2 as such a sub model is not available for F1000. Network modules may be replaced in case of failure. Spare parts for redundant power supply can be ordered separately.

All performance values are measured under optimized conditions and are to be considered as „up to“ values and may vary depending on system configuration and infrastructure:

- a Firewall throughput measured with large UDP packets (MTU1500), bi-directional across multiple ports.
- b SD-WAN throughput is based on 1415 Byte UDP packets, bidirectional using BreakingPoint traffic generator.
- c IPS throughput is measured with large UDP packets (MTU1500) and across multiple ports.
- d NGFW throughput is measured with IPS, application control, and web filter enabled, based on BreakingPoint Realworld-IPS-Enterprise-Traffic-Mix, bidirectional across multiple ports.
- e Threat protection throughput is measured with IPS, application control, web filter, and cloud-based antivirus and SSL inspection enabled (as part of an active Advanced Threat Protection subscription), based on BreakingPoint Realworld-IPS-Enterprise-Traffic-Mix, bidirectional across multiple ports.
- f Depending on feature set; for more detailed information on sizing, please use the free sizing calculator on [Barracuda Campus](#).
- g MTBF according to common usage. High load on SSD and extreme environmental conditions might reduce MTBF.

Errors and omissions excepted. Specifications subject to change without notice.



# CloudGen Firewall F1000B.CFEQ

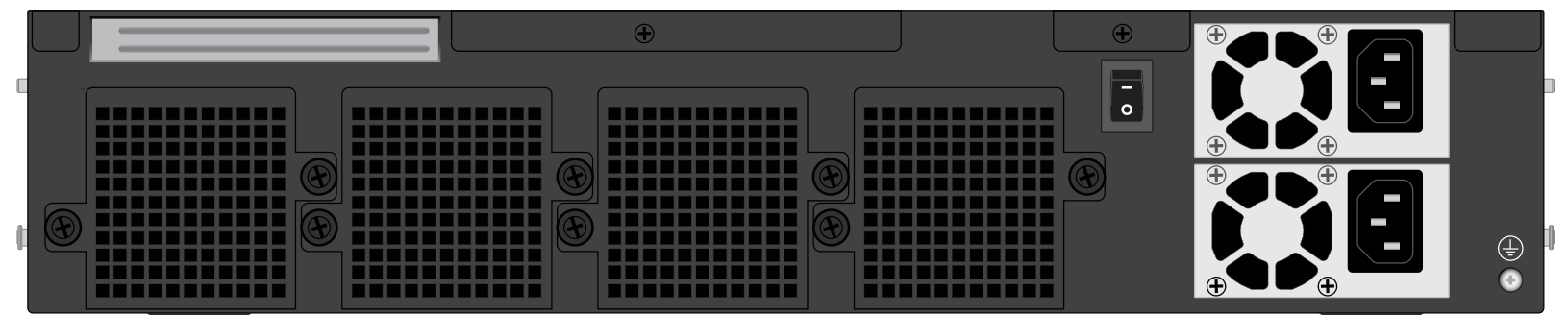

INTERFACES *	
Copper ethernet NICs (1 GbE)	16x
SFP fiber NICs (1 GbE)	16x
SFP+ fiber NICs (10 GbE)	6x
QSFP+ fiber NICs (40 GbE)	2x
USB 3.0	2x
IPMI	1x RJ45
Management	1x RJ45
Serial / console	1x RJ45
PERFORMANCE [AS OF FIRMWARE RELEASE 8.3.X]	
Firewall throughput [Gbps] <sup>[a]</sup>	52
SD-WAN throughput [AES-128, TINA std hash, Gbps] <sup>[b]</sup>	15.8
SD-WAN throughput [AES-256, TINA std hash, Gbps] <sup>[b]</sup>	14
SD-WAN throughput [AES-256, SHA256, Gbps] <sup>[b]</sup>	7.4
SD-WAN throughput [AES-256, MD5, Gbps] <sup>[b]</sup>	10.4
SD-WAN throughput [AES-256, GCM, Gbps] <sup>[b]</sup>	7.3
IPS throughput [Gbps] <sup>[c]</sup>	16
NGFW throughput [Gbps] <sup>[d]</sup>	14.8
Threat protection throughput [Gbps] <sup>[e]</sup>	13.5
Concurrent sessions	10,000,000
New sessions/s	250,000
Recommended number of concurrent users <sup>[f]</sup>	7,000-15,000
MEMORY	
RAM [GB]	128
MASS STORAGE	
Type	SSD
System disk size ([GB] or better)	550
System disk MTBF [hours]	1,200,000
Optional swappable disk size ([GB])	550
Optional swappable disk MTBF [hours]	1,200,000
SIZE, WEIGHT, DIMENSIONS	
Weight appliance [lbs] / [kg]	55.1 / 25.0
Appliance size: width x depth x height [in]	17.3 x 27.9 x 3.4
Appliance size: width x depth x height [mm]	440 x 710 x 88
Weight carton with appliance [lbs] / [kg]	57.3 / 26.0
Carton size: width x depth x height [in]	23.2 x 34.3 x 11.4
Carton size: width x depth x height [mm]	590 x 870 x 290
Form factor	2U rack mount
HARDWARE	
Display	✓
Cooling	Fan, hot swap
ENVIRONMENTAL	
Noise emission [db/A]	n/a
Operating temperature [°F] / [°C]	+32 to +104 / 0 to +40
Storage temperature [°F] / [°C]	-49 to +167 / -45 to +75
Operating humidity (non-condensing)	5% to 95%

MTBF [SYSTEM]	
MTBF [yrs.] <sup>[g]</sup>	> 4
POWER AND EFFICIENCY	
Power supply	Dual hot swap
Power supply type	Internal
Power type [AC/DC]	AC
Input ratings [Volts]	100-240
Input frequency [Hz]	50-60
Auto sense	✓
Max. power draw [W]	810
Max. power draw @ 120V [Amps]	6.8
Max. power draw @ 230V [Amps]	3.5
Max. heat dissipation [W]	680
Max. heat dissipation [BTU]	2,322
Energy efficiency (average)	> 86%
CERTIFICATIONS AND COMPLIANCE (ALSO SEE PAGE 104 FF)	
CE emissions	✓
CE electrical safety	✓
FCC emissions	✓
ROHS compliant	✓
PACKAGING CONTENT	
Appliance	✓
Straight network cable	✓
External power brick and cables	✓
USB flash drive for recovery and installation	✓
Quick start guide	✓
2x Barracuda L-shape rack mount bracket	✓
Barracuda rail kit	✓

\* Available sub models can be re-configured in the field. However, the re-configuration of network modules can be only applied to meet with available sub models. E.g., you may reconfigure from model CE0 to CE2 or CFE but not to a model CF2 as such a sub model is not available for F1000. Network modules may be replaced in case of failure. Spare parts for redundant power supply can be ordered separately.

All performance values are measured under optimized conditions and are to be considered as „up to“ values and may vary depending on system configuration and infrastructure:

- a Firewall throughput measured with large UDP packets (MTU1500), bi-directional across multiple ports.
- b SD-WAN throughput is based on 1415 Byte UDP packets, bidirectional using BreakingPoint traffic generator.
- c IPS throughput is measured with large UDP packets (MTU1500) and across multiple ports.
- d NGFW throughput is measured with IPS, application control, and web filter enabled, based on BreakingPoint Realworld-IPS-Enterprise-Traffic-Mix, bidirectional across multiple ports.
- e Threat protection throughput is measured with IPS, application control, web filter, and cloud-based antivirus and SSL inspection enabled (as part of an active Advanced Threat Protection subscription), based on BreakingPoint Realworld-IPS-Enterprise-Traffic-Mix, bidirectional across multiple ports.
- f Depending on feature set; for more detailed information on sizing, please use the free sizing calculator on [Barracuda Campus](#).
- g MTBF according to common usage. High load on SSD and extreme environmental conditions might reduce MTBF.

Errors and omissions excepted. Specifications subject to change without notice.



SPECIFICATIONS - DIN RAIL MOUNTABLE / RUGGED MODELS

# CloudGen Firewall F93A.R

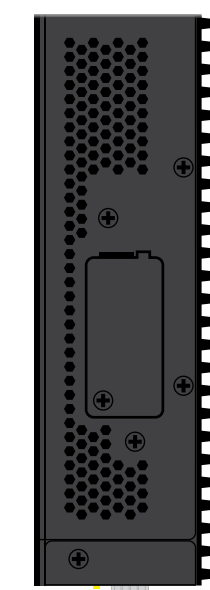
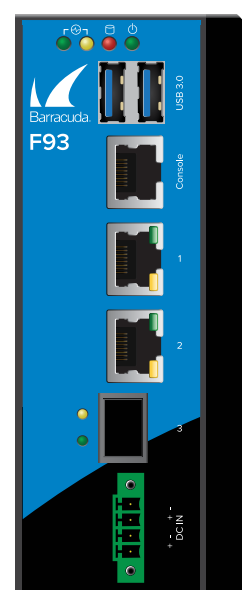

INTERFACES	
Copper ethernet NICs (1 GbE RJ45)	2x
SFP fiber NICs (1 GbE)	1x
USB 3.0	2x
ESD protection	15KV
PERFORMANCE [AS OF FIRMWARE RELEASE 8.3.X]	
Firewall throughput [Gbps] <sup>[a]</sup>	1.5
SD-WAN throughput [AES-128, TINA std hash, Mbps] <sup>[b]</sup>	240
SD-WAN throughput [AES-256, TINA std hash, Mbps] <sup>[b]</sup>	200
SD-WAN throughput [AES-256, SHA256, Mbps] <sup>[b]</sup>	180
SD-WAN throughput [AES-256, MD5, Mbps] <sup>[b]</sup>	200
SD-WAN throughput [AES-256, GCM, Mbps] <sup>[b]</sup>	180
IPS throughput [Mbps] <sup>[c]</sup>	400
NGFW throughput [Mbps] <sup>[d]</sup>	400
Threat protection throughput [Mbps] <sup>[e]</sup>	380
Concurrent sessions	80,000
New sessions/s	8,000
Recommended number of concurrent users <sup>[f]</sup>	50-100
MEMORY	
RAM [GB]	4
MASS STORAGE	
Type	SSD
Size [(GB) or better]	100
SIZE, WEIGHT, DIMENSIONS (ALSO SEE PAGE 62)	
Weight appliance [lbs] / [kg]	2.6 / 1.2
Appliance size: width x depth x height [in]	2.04 x 5.9 x 5.11
Appliance size: width x depth x height [mm]	52 x 150 x 130
Weight carton with appliance [lbs] / [kg]	4.8 / 2.2
Carton size: width x depth x height [in]	10 x 10 x 12
Carton size: width x depth x height [mm]	254 x 254 x 305
Form factor	Compact, DIN rail mount
HARDWARE	
Cooling	Fanless
ENVIRONMENTAL	
Noise emission [db/A]	n/a
Operating temperature [°F] / [°C]	-40 to +167 / -40 to +75
Storage temperature [°F] / [°C]	-40 to +185 / -40 to +85
Operating humidity (non-condensing)	5% to 95%
Magnetic isolation protection	1.5KV built-in
Working temperature external power supply (optional) [°F] / [°C]	32 to +158 / 0 to +70 (de-rating above 104°F) (de-rating above 40°C)

MTBF [SYSTEM]	
MTBF [yrs.] <sup>[g]</sup>	> 9
POWER AND EFFICIENCY	
Power supply (default)	Single
Power supply type (default)	Phoenix 4-pin with lock
Power supply (optional)	Dual (via two optional PSUs)
Power supply type (optional)	External power brick
Power type [AC/DC]	DC
Input ratings [Volts]	12-36
Max. power draw [W]	60
Max. power draw @ 24V [Amps]	2.5
Max. heat dissipation [W]	60
CERTIFICATIONS AND COMPLIANCE (ALSO SEE PAGE 104)	
CE emissions	✓
CE electrical safety	✓
FCC emissions	✓
ROHS compliant	✓
Shock and vibration resistance	IEC 60068 IEC 60950 IEC 61000 ISTA 2A
Protection classification	IP20
PACKAGING CONTENT	
Appliance	✓
DIN rail mount bracket	✓
Quick start guide	✓

All performance values are measured under optimized conditions and are to be considered as „up to“ values and may vary depending on system configuration and infrastructure:

- a Firewall throughput measured with large UDP packets (MTU1500), bi-directional across multiple ports.
- b SD-WAN throughput is based on 1415 Byte UDP packets, bidirectional using BreakingPoint traffic generator.
- c IPS throughput is measured with large UDP packets (MTU1500) and across multiple ports.
- d NGFW throughput is measured with IPS, application control, and web filter enabled, based on BreakingPoint Realworld-IPS-Enterprise-Traffic-Mix, bidirectional across multiple ports.
- e Threat protection throughput is measured with IPS, application control, web filter, and cloud-based antivirus and SSL inspection enabled (as part of an active Advanced Threat Protection subscription), based on BreakingPoint Realworld-IPS-Enterprise-Traffic-Mix, bidirectional across multiple ports.
- f Depending on feature set; for more detailed information on sizing, please use the free sizing calculator on [Barracuda Campus](#).
- g MTBF according to common usage. High load on SSD and extreme environmental conditions might reduce MTBF.

Errors and omissions excepted. Specifications subject to change without notice.



# CloudGen Firewall F193A.R

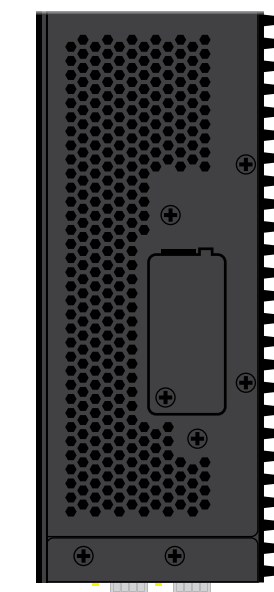
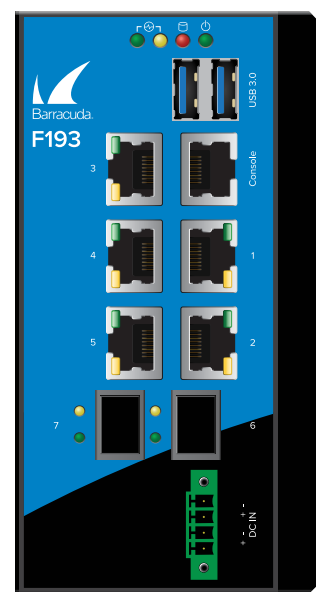

INTERFACES	
Copper ethernet NICs (1 GbE RJ45)	5x
SFP fiber NICs (1 GbE)	2x
USB 3.0	2x
ESD protection	15KV
PERFORMANCE [AS OF FIRMWARE RELEASE 8.3.X]	
Firewall throughput [Gbps] <sup>[a]</sup>	2.1
SD-WAN throughput [AES-128, TINA std hash, Mbps] <sup>[b]</sup>	320
SD-WAN throughput [AES-256, TINA std hash, Mbps] <sup>[b]</sup>	300
SD-WAN throughput [AES-256, SHA256, Mbps] <sup>[b]</sup>	190
SD-WAN throughput [AES-256, MD5, Mbps] <sup>[b]</sup>	270
SD-WAN throughput [AES-256, GCM, Mbps] <sup>[b]</sup>	190
IPS throughput [Mbps] <sup>[c]</sup>	790
NGFW throughput [Mbps] <sup>[d]</sup>	800
Threat protection throughput [Mbps] <sup>[e]</sup>	700
Concurrent sessions	100,000
New sessions/s	9,000
Recommended number of concurrent users <sup>[f]</sup>	75-150
MEMORY	
RAM [GB]	4
MASS STORAGE	
Type	SSD
Size [(GB) or better]	100
SIZE, WEIGHT, DIMENSIONS (ALSO SEE PAGE 63)	
Weight appliance [lbs] / [kg]	3.1 / 1.4
Appliance size: width x depth x height [in]	2.67 x 5.9 x 5.11
Appliance size: width x depth x height [mm]	68 x 150 x 130
Weight carton with appliance [lbs] / [kg]	4.8 / 2.33
Carton size: width x depth x height [in]	10 x 10 x 12
Carton size: width x depth x height [mm]	254 x 254 x 305
Form factor	Compact, DIN rail mount
HARDWARE	
Cooling	Fanless
ENVIRONMENTAL	
Noise emission [db/A]	n/a
Operating temperature [°F] / [°C]	-40 to +167 / -40 to +75
Storage temperature [°F] / [°C]	-40 to +185 / -40 to +85
Operating humidity (non-condensing)	5% to 95%
Magnetic isolation protection	1.5KV built-in
Working temperature external power supply (optional) [°F] / [°C]	32 to +158 (de-rating above 104°F) / 0 to +70 (de-rating above 40°C)

MTBF [SYSTEM]	
MTBF [yrs.] <sup>[g]</sup>	> 9
POWER AND EFFICIENCY	
Power supply (default)	Single
Power supply type (default)	Phoenix 4-pin with lock
Power supply (optional)	Dual (via two optional PSUs)
Power supply type (optional)	External power brick
Power type [AC/DC]	DC
Input ratings [Volts]	12-36
Max. power draw [W]	60
Max. power draw @ 24V [Amps]	2.5
Max. heat dissipation [W]	60
CERTIFICATIONS AND COMPLIANCE (ALSO SEE PAGE 104 FF)	
CE emissions	✓
CE electrical safety	✓
FCC emissions	✓
ROHS compliant	✓
Shock and vibration resistance	IEC 60068 IEC 60950 IEC 61000 ISTA 2A
Protection classification	IP20
PACKAGING CONTENT	
Appliance	✓
DIN rail mount bracket	✓
Quick start guide	✓

All performance values are measured under optimized conditions and are to be considered as „up to“ values and may vary depending on system configuration and infrastructure:

- a Firewall throughput measured with large UDP packets (MTU1500), bi-directional across multiple ports.
- b SD-WAN throughput is based on 1415 Byte UDP packets, bidirectional using BreakingPoint traffic generator.
- c IPS throughput is measured with large UDP packets (MTU1500) and across multiple ports.
- d NGFW throughput is measured with IPS, application control, and web filter enabled, based on BreakingPoint Realworld-IPS-Enterprise-Traffic-Mix, bidirectional across multiple ports.
- e Threat protection throughput is measured with IPS, application control, web filter, and cloud-based antivirus and SSL inspection enabled (as part of an active Advanced Threat Protection subscription), based on BreakingPoint Realworld-IPS-Enterprise-Traffic-Mix, bidirectional across multiple ports.
- f Depending on feature set; for more detailed information on sizing, please use the free sizing calculator on [Barracuda Campus](#).
- g MTBF according to common usage. High load on SSD and extreme environmental conditions might reduce MTBF.

Errors and omissions excepted. Specifications subject to change without notice.



# Secure Connector 20

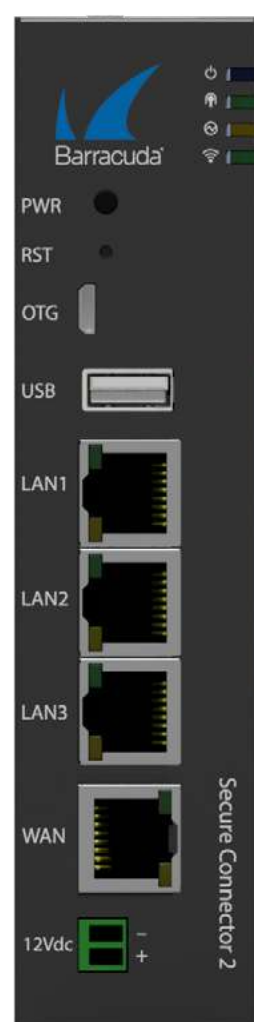

INTERFACES	
WAN copper ethernet NICs (PoE-recipient; 1 GbE)	1x
LAN copper NICs (LAN switch; 1 GbE)	3x
USB 2.0	1
Micro-USB OTG	1
WiFi (access point / client mode)	-
SUPPORTED CELLULAR NETWORKS	
GSM / UMTS	-
4G / LTE	-
PERFORMANCE [AS OF FIRMWARE RELEASE 8.3.X]	
Firewall throughput (UDP) [Mbps]	300
WiFi AP mode throughput (UDP) [Mbps]	N/A
Site performance (up to) (AES-128, SHA) [Mbps] <sup>[a]</sup>	30
MEMORY	
RAM [GB]	1
MASS STORAGE	
Type	Micro SD
Size [GB]	16
SIZE, WEIGHT, DIMENSIONS (ALSO SEE PAGE 64)	
Weight appliance [lbs] / [kg]	1.21 / 0.55
Appliance size: width x depth x height [in]	1.5 x 5.5 x 5.9
Appliance size: width x depth x height [mm]	37 x 140 x 150
Weight carton with appliance [lbs] / [kg]	1.98 / 0.9
Carton size: width x depth x height [in]	2.6 x 9.1 x 10.8
Carton size: width x depth x height [mm]	65 x 230 x 275
Form factor	Compact, DIN rail
HARDWARE	
Cooling	Fanless
ENVIRONMENTAL	
Noise emission [db/A]	N/A
Operating temperature [°F] / [°C]	+30 to +105 / 0 to +40
Storage temperature [°F] / [°C]	-5 to +160 / -20 to +70
Operating humidity (non-condensing)	5% to 95%

This appliance is PoE-recipient compatible and, thus, has no external power brick included. However, an external power brick can be ordered as an option.

MTBF [SYSTEM]	
MTBF [yrs.] <sup>[b]</sup>	> 5
POWER & EFFICIENCY	
AuxDC in voltage range (2-pin terminal block MC420 3.5mm) [V]	12 - 57
WAN Port PoE Voltage range [V]	37 - 54
Compatible PoE provider (PSE)	IEEE 802.3at (Type 2) PD
POWER SUPPLY (OPTIONAL)	
Power supply	Single
Power supply type	External brick
Power type [AC/DC]	AC
Input rating [Volts]	100-240
Input frequency [Hz]	50-60
Max. power draw [W]	40
Max. power draw @ 12V [Amps.]	3.33
Max. heat dissipation [W]	40
Max. heat dissipation [BTU]	205
Energy efficiency [average]	> 83%
CERTIFICATIONS AND COMPLIANCE (ALSO SEE PAGE 104 FF)	
CE emissions	✓
CE electrical safety	✓
FCC emissions	✓
ROHS compliant	✓
PACKAGING CONTENT	
Appliance	✓
Straight network cable	✓
USB type A to MicroUSB cable	✓
External power brick & cables	Optional
Quick start guide	✓
1x DIN rail bracket	✓
1x 2-pin power connector	✓
2x WiFi antenna	-
2x Cellular antenna with 1.5m cable	-

All performance values are measured under optimized conditions and are to be considered as „up to“ values and may vary depending on system configuration and infrastructure:

- a Site performance is based on 1415 Byte UDP packets, bidirectional using BreakingPoint traffic generator.
- b MTBF according to common usage. High load on SSD and extreme environmental conditions might reduce MTBF.

Errors and omissions excepted. Specifications subject to change without notice.



# Secure Connector 21

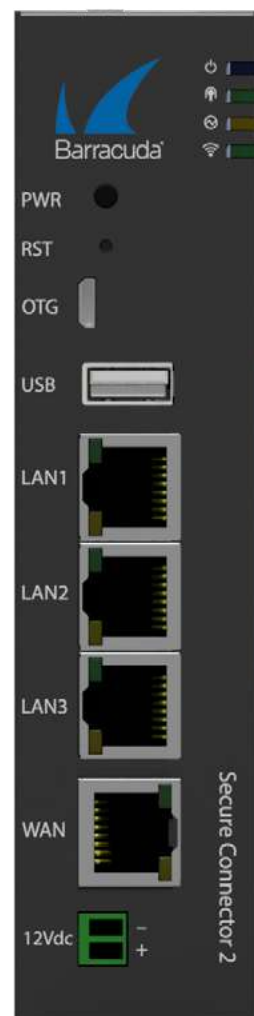

INTERFACES	
WAN copper ethernet NICs (PoE-recipient; 1 GbE)	1x
LAN copper NICs (LAN switch; 1 GbE)	3x
USB 2.0	1
Micro-USB OTG	1
WiFi (access point / client mode)	✓
SUPPORTED CELLULAR NETWORKS	
GSM / UMTS	-
4G / LTE	-
PERFORMANCE [AS OF FIRMWARE RELEASE 8.3.X]	
Firewall throughput (UDP) [Mbps]	300
WiFi AP mode throughput (UDP) [Mbps]	80
Site performance (up to) (AES-128, SHA) [Mbps] <sup>[a]</sup>	30
MEMORY	
RAM [GB]	1
MASS STORAGE	
Type	Micro SD
Size [GB]	16
SIZE, WEIGHT, DIMENSIONS (ALSO SEE PAGE 65)	
Weight appliance [lbs] / [kg]	1.21 / 0.55
Appliance size: width x depth x height [in]	1.5 x 5.5 x 5.9
Appliance size: width x depth x height [mm]	37 x 140 x 150
Weight carton with appliance [lbs] / [kg]	1.98 / 0.9
Carton size: width x depth x height [in]	2.6 x 9.1 x 10.8
Carton size: width x depth x height [mm]	65 x 230 x 275
Form factor	Compact, DIN rail
HARDWARE	
Cooling	Fanless
ENVIRONMENTAL	
Noise emission [db/A]	N/A
Operating temperature [°F] / [°C]	+30 to +105 / 0 to +40
Storage temperature [°F] / [°C]	-5 to +160 / -20 to +70
Operating humidity (non-condensing)	5% to 95%

This appliance is PoE-recipient compatible and, thus, has no external power brick included. However, an external power brick can be ordered as an option.

MTBF [SYSTEM]	
MTBF [yrs.] <sup>[b]</sup>	> 5
POWER & EFFICIENCY	
AuxDC in voltage range (2-pin terminal block MC420 3.5mm) [V]	12 - 57
WAN Port PoE Voltage range [V]	37 - 54
Compatible PoE provider (PSE)	IEEE 802.3at (Type 2) PD
POWER SUPPLY (OPTIONAL)	
Power supply	Single
Power supply type	External brick
Power type [AC/DC]	AC
Input rating [Volts]	100-240
Input frequency [Hz]	50-60
Max. power draw [W]	40
Max. power draw @ 12V [Amps.]	3.33
Max. heat dissipation [W]	40
Max. heat dissipation [BTU]	205
Energy efficiency [average]	> 83%
CERTIFICATIONS AND COMPLIANCE (ALSO SEE PAGE 104 FF)	
CE emissions	✓
CE electrical safety	✓
FCC emissions	✓
ROHS compliant	✓
PACKAGING CONTENT	
Appliance	✓
Straight network cable	✓
USB type A to MicroUSB cable	✓
External power brick & cables	Optional
Quick start guide	✓
1x DIN rail bracket	✓
1x 2-pin power connector	✓
2x WiFi antenna	✓
2x Cellular antenna with 1.5m cable	-

All performance values are measured under optimized conditions and are to be considered as „up to“ values and may vary depending on system configuration and infrastructure:

- a Site performance is based on 1415 Byte UDP packets, bidirectional using BreakingPoint traffic generator.
- b MTBF according to common usage. High load on SSD and extreme environmental conditions might reduce MTBF.

Errors and omissions excepted. Specifications subject to change without notice.



# Secure Connector 24

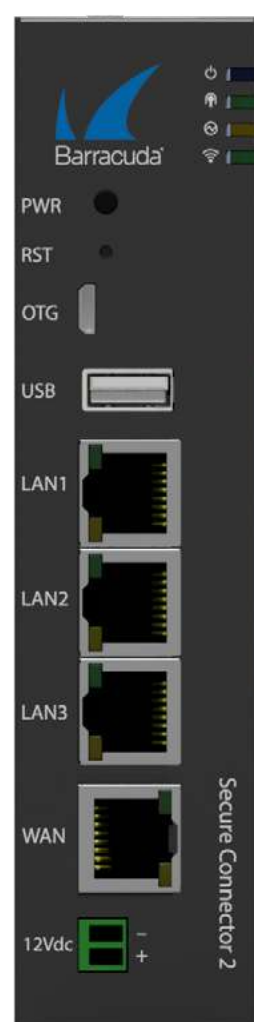

INTERFACES	
WAN copper ethernet NICs (PoE-recipient; 1 GbE)	1x
LAN copper NICs (LAN switch; 1 GbE)	3x
USB 2.0	1
Micro-USB OTG	1
WiFi (access point / client mode)	-
SUPPORTED CELLULAR NETWORKS	
GSM / UMTS	✓ (International)
4G / LTE	✓ (International)
PERFORMANCE [AS OF FIRMWARE RELEASE 8.3.X]	
Firewall throughput (UDP) [Mbps]	300
WiFi AP mode throughput (UDP) [Mbps]	N/A
Site performance (up to) (AES-128, SHA) [Mbps] <sup>[a]</sup>	30
MEMORY	
RAM [GB]	1
MASS STORAGE	
Type	Micro SD
Size [GB]	16
SIZE, WEIGHT, DIMENSIONS (ALSO SEE PAGE 66)	
Weight appliance [lbs] / [kg]	1.21 / 0.55
Appliance size: width x depth x height [in]	1.5 x 5.5 x 5.9
Appliance size: width x depth x height [mm]	37 x 140 x 150
Weight carton with appliance [lbs] / [kg]	1.98 / 0.9
Carton size: width x depth x height [in]	2.6 x 9.1 x 10.8
Carton size: width x depth x height [mm]	65 x 230 x 275
Form factor	Compact, DIN rail
HARDWARE	
Cooling	Fanless
ENVIRONMENTAL	
Noise emission [db/A]	N/A
Operating temperature [°F] / [°C]	+30 to +105 / 0 to +40
Storage temperature [°F] / [°C]	-5 to +160 / -20 to +70
Operating humidity (non-condensing)	5% to 95%

This appliance is PoE-recipient compatible and, thus, has no external power brick included. However, an external power brick can be ordered as an option.

MTBF [SYSTEM]	
MTBF [yrs.] <sup>[b]</sup>	> 5
POWER & EFFICIENCY	
AuxDC in voltage range (2-pin terminal block MC420 3.5mm) [V]	12 - 57
WAN Port PoE Voltage range [V]	37 - 54
Compatible PoE provider (PSE)	IEEE 802.3at (Type 2) PD
POWER SUPPLY (OPTIONAL)	
Power supply	Single
Power supply type	External brick
Power type [AC/DC]	AC
Input rating [Volts]	100-240
Input frequency [Hz]	50-60
Max. power draw [W]	40
Max. power draw @ 12V [Amps.]	3.33
Max. heat dissipation [W]	40
Max. heat dissipation [BTU]	205
Energy efficiency [average]	> 83%
CERTIFICATIONS AND COMPLIANCE (ALSO SEE PAGE 104 FF)	
CE emissions	✓
CE electrical safety	✓
FCC emissions	✓
ROHS compliant	✓
PACKAGING CONTENT	
Appliance	✓
Straight network cable	✓
USB type A to MicroUSB cable	✓
External power brick & cables	Optional
Quick start guide	✓
1x DIN rail bracket	✓
1x 2-pin power connector	✓
2x WiFi antenna	-
2x Cellular antenna with 1.5m cable	✓

All performance values are measured under optimized conditions and are to be considered as „up to“ values and may vary depending on system configuration and infrastructure:

- a Site performance is based on 1415 Byte UDP packets, bidirectional using BreakingPoint traffic generator.
- b MTBF according to common usage. High load on SSD and extreme environmental conditions might reduce MTBF.

Errors and omissions excepted. Specifications subject to change without notice.



# Secure Connector 25

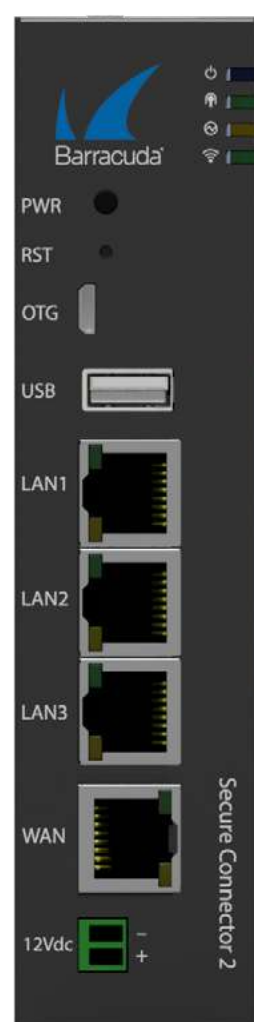

INTERFACES	
WAN copper ethernet NICs (PoE-recipient; 1 GbE)	1x
LAN copper NICs (LAN switch; 1 GbE)	3x
USB 2.0	1
Micro-USB OTG	1
WiFi (access point / client mode)	✓
SUPPORTED CELLULAR NETWORKS	
GSM / UMTS	✓ (International)
4G / LTE	✓ (International)
PERFORMANCE [AS OF FIRMWARE RELEASE 8.3.X]	
Firewall throughput (UDP) [Mbps]	300
WiFi AP mode throughput (UDP) [Mbps]	80
Site performance (up to) (AES-128, SHA) [Mbps] <sup>[a]</sup>	30
MEMORY	
RAM [GB]	1
MASS STORAGE	
Type	Micro SD
Size [GB]	16
SIZE, WEIGHT, DIMENSIONS (ALSO SEE PAGE 67)	
Weight appliance [lbs] / [kg]	1.21 / 0.55
Appliance size: width x depth x height [in]	1.5 x 5.5 x 5.9
Appliance size: width x depth x height [mm]	37 x 140 x 150
Weight carton with appliance [lbs] / [kg]	1.98 / 0.9
Carton size: width x depth x height [in]	2.6 x 9.1 x 10.8
Carton size: width x depth x height [mm]	65 x 230 x 275
Form factor	Compact, DIN rail
HARDWARE	
Cooling	Fanless
ENVIRONMENTAL	
Noise emission [db/A]	N/A
Operating temperature [°F] / [°C]	+30 to +105 / 0 to +40
Storage temperature [°F] / [°C]	-5 to +160 / -20 to +70
Operating humidity (non-condensing)	5% to 95%

This appliance is PoE-recipient compatible and, thus, has no external power brick included. However, an external power brick can be ordered as an option.

MTBF [SYSTEM]	
MTBF [yrs.] <sup>[b]</sup>	> 5
POWER & EFFICIENCY	
AuxDC in voltage range (2-pin terminal block MC420 3.5mm) [V]	12 - 57
WAN Port PoE Voltage range [V]	37 - 54
Compatible PoE provider (PSE)	IEEE 802.3at (Type 2) PD
POWER SUPPLY (OPTIONAL)	
Power supply	Single
Power supply type	External brick
Power type [AC/DC]	AC
Input rating [Volts]	100-240
Input frequency [Hz]	50-60
Max. power draw [W]	40
Max. power draw @ 12V [Amps.]	3.33
Max. heat dissipation [W]	40
Max. heat dissipation [BTU]	205
Energy efficiency [average]	> 83%
CERTIFICATIONS AND COMPLIANCE (ALSO SEE PAGE 104 FF)	
CE emissions	✓
CE electrical safety	✓
FCC emissions	✓
ROHS compliant	✓
PACKAGING CONTENT	
Appliance	✓
Straight network cable	✓
USB type A to MicroUSB cable	✓
External power brick & cables	Optional
Quick start guide	✓
1x DIN rail bracket	✓
1x 2-pin power connector	✓
2x WiFi antenna	✓
2x Cellular antenna with 1.5m cable	✓

All performance values are measured under optimized conditions and are to be considered as „up to“ values and may vary depending on system configuration and infrastructure:

- a Site performance is based on 1415 Byte UDP packets, bidirectional using BreakingPoint traffic generator.
- b MTBF according to common usage. High load on SSD and extreme environmental conditions might reduce MTBF.

Errors and omissions excepted. Specifications subject to change without notice.



# Secure Connector 30

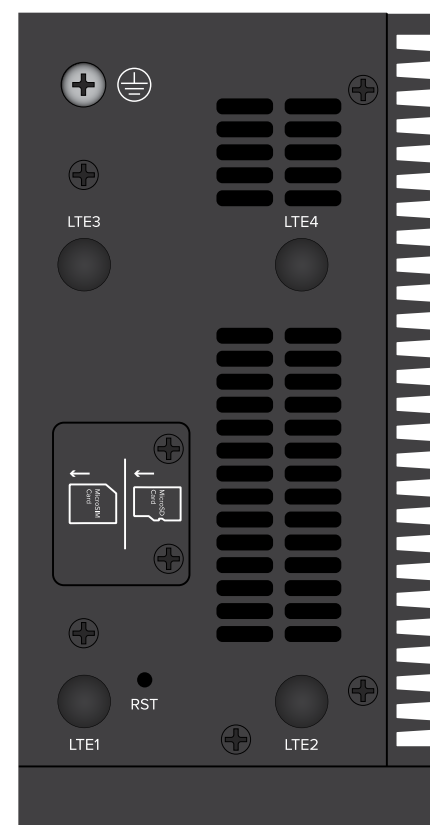
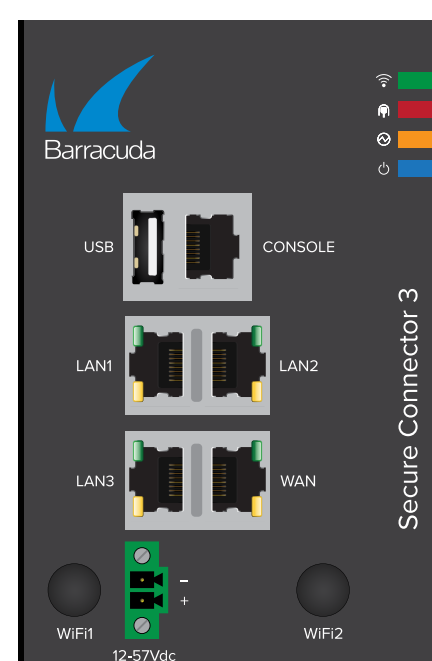

INTERFACES	
WAN copper ethernet NICs (PoE-recipient; 1 GbE)	1x
LAN copper NICs (LAN switch; 1 GbE)	3x
USB 2.0	1
Serial console	RJ45
WiFi (access point / client mode)	N/A
SUPPORTED CELLULAR NETWORKS	
4G / LTE	N/A
PERFORMANCE [AS OF FIRMWARE RELEASE 8.3.X]	
Firewall throughput (UDP) [Mbps]	300
WiFi AP mode throughput (UDP) [Mbps]	N/A
Site performance (up to) (AES-128, SHA) [Mbps] <sup>[a]</sup>	30
MEMORY	
RAM [GB]	2
MASS STORAGE	
Size On-board [GB]	8
Size Micro SD [GB]	16
SIZE, WEIGHT, DIMENSIONS (ALSO SEE PAGE 68)	
Weight appliance [lbs] / [kg]	2.42 / 1.1
Appliance size: width x depth x height [in]	3.03 x 4.72 x 5.91
Appliance size: width x depth x height [mm]	77 x 120 x 150
Weight carton with appliance [lbs] / [kg]	t.b.a. / t.b.a.
Carton size: width x depth x height [in]	t.b.a.
Carton size: width x depth x height [mm]	t.b.a.
Form factor	Rugged, DIN rail
HARDWARE	
Cooling	Fanless
ENVIRONMENTAL	
Noise emission [db/A]	N/A
Operating temperature [°F] / [°C]	-4 to +158 / -20 to +70
Storage temperature [°F] / [°C]	-4 to +158 / -20 to +70
Operating humidity (non-condensing)	5% to 95%

This appliance is PoE-recipient compatible and, thus, has no external power brick included. However, an external power brick can be ordered as an option.

MTBF [SYSTEM]	
MTBF [yrs.] <sup>b</sup>	> 5
POWER & EFFICIENCY	
AuxDC in voltage range (2-pin terminal block MC420 3.5mm) [V]	12 - 57
WAN Port PoE Voltage range [V]	37 - 54
Compatible PoE provider (PSE)	IEEE 802.3at (Type 2) PD
POWER SUPPLY (OPTIONAL)	
Power supply	Single, external
Power supply type	External brick
Power type [AC/DC]	DC
Input rating [Volts]	12-36
Max. power draw [W]	60
Max. power draw @ 12V [Amps.]	2.5
Max. heat dissipation [W]	60
Max. heat dissipation [BTU]	205
Energy efficiency [average]	> 83%
CERTIFICATIONS AND COMPLIANCE (ALSO SEE PAGE 104 FF)	
CE emissions	✓
CE electrical safety	✓
FCC emissions	✓
ROHS compliant	✓
Shock and vibration resistance	IEC 60068 IEC 60950 IEC 61000 ISTA 2A
Protection classification	IP20 standard
PACKAGING CONTENT	
Appliance	✓
Straight network cable	✓
External power brick & cables	Optional
Quick start guide	✓
1x DIN rail bracket	✓
1x 2-pin power connector	✓

All performance values are measured under optimized conditions and are to be considered as „up to“ values and may vary depending on system configuration and infrastructure:

- a Site performance is based on 1415 Byte UDP packets, bidirectional using BreakingPoint traffic generator.
- b MTBF according to common usage. High load on SSD and extreme environmental conditions might reduce MTBF.

Errors and omissions excepted. Specifications subject to change without notice.



# Secure Connector 31

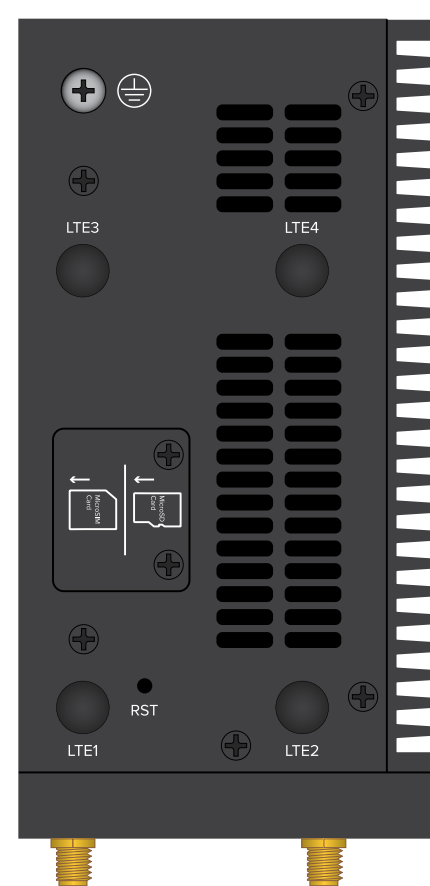
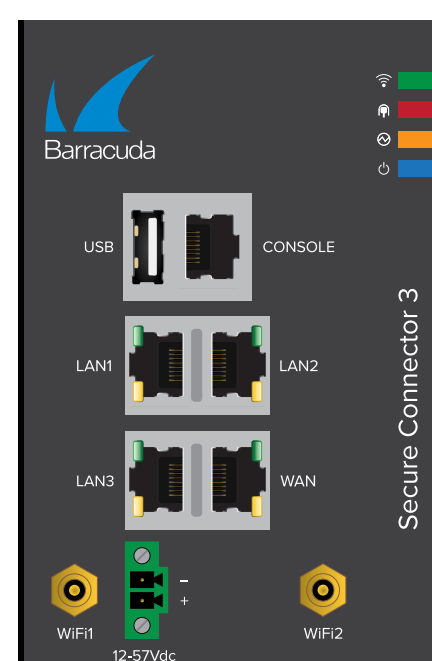

INTERFACES		
WAN copper ethernet NICs (PoE-recipient; 1 GbE)		1x
LAN copper NICs (LAN switch; 1 GbE)		3x
USB 2.0		1
Serial console		RJ45
WiFi (access point / client mode)		✓
SUPPORTED CELLULAR NETWORKS		
4G / LTE		N/A
PERFORMANCE [AS OF FIRMWARE RELEASE 8.3.X]		
Firewall throughput (UDP) [Mbps]		300
WiFi AP mode throughput (UDP) [Mbps]		80
Site performance (up to) (AES-128, SHA) [Mbps] <sup>[a]</sup>		30
MEMORY		
RAM [GB]		2
MASS STORAGE		
Size On-board [GB]		8
Size Micro SD [GB]		16
SIZE, WEIGHT, DIMENSIONS (ALSO SEE PAGE 69)		
Weight appliance [lbs] / [kg]	2.42 / 1.1	
Appliance size: width x depth x height [in]	3.03 x 4.72 x 5.91	
Appliance size: width x depth x height [mm]	77 x 120 x 150	
Weight carton with appliance [lbs] / [kg]	t.b.a. / t.b.a.	
Carton size: width x depth x height [in]	t.b.a.	
Carton size: width x depth x height [mm]	t.b.a.	
Form factor		Rugged, DIN rail
HARDWARE		
Cooling		Fanless
ENVIRONMENTAL		
Noise emission [db/A]		N/A
Operating temperature [°F] / [°C]		-4 to +158 / -20 to +70
Storage temperature [°F] / [°C]		-4 to +158 / -20 to +70
Operating humidity (non-condensing)		5% to 95%

This appliance is PoE-recipient compatible and, thus, has no external power brick included. However, an external power brick can be ordered as an option.

MTBF [SYSTEM]	
MTBF [yrs.] <sup>[b]</sup>	> 5
POWER & EFFICIENCY	
AuxDC in voltage range (2-pin terminal block MC420 3.5mm) [V]	12 - 57
WAN Port PoE Voltage range [V]	37 - 54
Compatible PoE provider (PSE)	IEEE 802.3at (Type 2) PD
POWER SUPPLY (OPTIONAL)	
Power supply	Single, external
Power supply type	External brick
Power type [AC/DC]	DC
Input rating [Volts]	12-36
Max. power draw [W]	60
Max. power draw @ 12V [Amps.]	2.5
Max. heat dissipation [W]	60
Max. heat dissipation [BTU]	205
Energy efficiency [average]	> 83%
CERTIFICATIONS AND COMPLIANCE (ALSO SEE PAGE 104 FF)	
CE emissions	✓
CE electrical safety	✓
FCC emissions	✓
ROHS compliant	✓
Shock and vibration resistance	IEC 60068 IEC 60950 IEC 61000 ISTA 2A
Protection classification	IP20 standard
PACKAGING CONTENT	
Appliance	✓
Straight network cable	✓
External power brick & cables	Optional
Quick start guide	✓
1x DIN rail bracket	✓
1x 2-pin power connector	✓
2x WiFi antenna	✓
4x Cellular antenna with 1.5m cable	✓

All performance values are measured under optimized conditions and are to be considered as „up to“ values and may vary depending on system configuration and infrastructure:

- a Site performance is based on 1415 Byte UDP packets, bidirectional using BreakingPoint traffic generator.
- b MTBF according to common usage. High load on SSD and extreme environmental conditions might reduce MTBF.

Errors and omissions excepted. Specifications subject to change without notice.



# Secure Connector 34

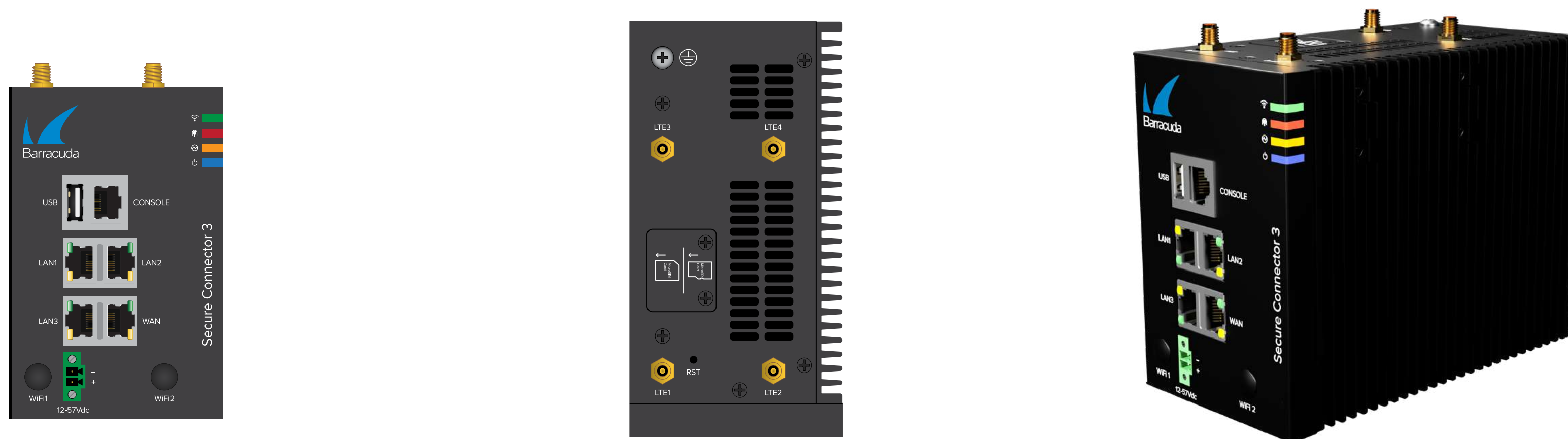

INTERFACES		
WAN copper ethernet NICs (PoE-recipient; 1 GbE)		1x
LAN copper NICs (LAN switch; 1 GbE)		3x
USB 2.0		1
Serial console		RJ45
WiFi (access point / client mode)		N/A
SUPPORTED CELLULAR NETWORKS		
4G / LTE		✓
PERFORMANCE [AS OF FIRMWARE RELEASE 8.3.X]		
Firewall throughput (UDP) [Mbps]		300
WiFi AP mode throughput (UDP) [Mbps]		N/A
Site performance (up to) (AES-128, SHA) [Mbps] <sup>[a]</sup>		30
MEMORY		
RAM [GB]		2
MASS STORAGE		
Size On-board [GB]		8
Size Micro SD [GB]		16
SIZE, WEIGHT, DIMENSIONS (ALSO SEE PAGE 70)		
Weight appliance [lbs] / [kg]	2.42	/ 1.1
Appliance size: width x depth x height [in]	3.03 x 4.72 x 5.91	
Appliance size: width x depth x height [mm]	77 x 120 x 150	
Weight carton with appliance [lbs] / [kg]	t.b.a.	/ t.b.a.
Carton size: width x depth x height [in]	t.b.a.	
Carton size: width x depth x height [mm]	t.b.a.	
Form factor	Rugged, DIN rail	
HARDWARE		
Cooling	Fanless	
ENVIRONMENTAL		
Noise emission [db/A]	N/A	
Operating temperature [°F] / [°C]	-4 to +158 / -20 to +70	
Storage temperature [°F] / [°C]	-4 to +158 / -20 to +70	
Operating humidity (non-condensing)	5% to 95%	

This appliance is PoE-recipient compatible and, thus, has no external power brick included. However, an external power brick can be ordered as an option.

MTBF [SYSTEM]	
MTBF [yrs.] <sup>[b]</sup>	> 5
POWER & EFFICIENCY	
AuxDC in voltage range (2-pin terminal block MC420 3.5mm) [V]	12 - 57
WAN Port PoE Voltage range [V]	37 - 54
Compatible PoE provider (PSE)	IEEE 802.3at (Type 2) PD
POWER SUPPLY (OPTIONAL)	
Power supply	Single, external
Power supply type	External brick
Power type [AC/DC]	DC
Input rating [Volts]	12-36
Max. power draw [W]	60
Max. power draw @ 12V [Amps.]	2.5
Max. heat dissipation [W]	60
Max. heat dissipation [BTU]	205
Energy efficiency [average]	> 83%
CERTIFICATIONS AND COMPLIANCE (ALSO SEE PAGE 104 FF)	
CE emissions	✓
CE electrical safety	✓
FCC emissions	✓
ROHS compliant	✓
Shock and vibration resistance	IEC 60068 IEC 60950 IEC 61000 ISTA 2A
Protection classification	IP20 standard
PACKAGING CONTENT	
Appliance	✓
Straight network cable	✓
External power brick & cables	Optional
Quick start guide	✓
1x DIN rail bracket	✓
1x 2-pin power connector	✓
4x Cellular antenna with 1.5m cable	✓

All performance values are measured under optimized conditions and are to be considered as „up to“ values and may vary depending on system configuration and infrastructure:

- a Site performance is based on 1415 Byte UDP packets, bidirectional using BreakingPoint traffic generator.
- b MTBF according to common usage. High load on SSD and extreme environmental conditions might reduce MTBF.

Errors and omissions excepted. Specifications subject to change without notice.



# Secure Connector 35

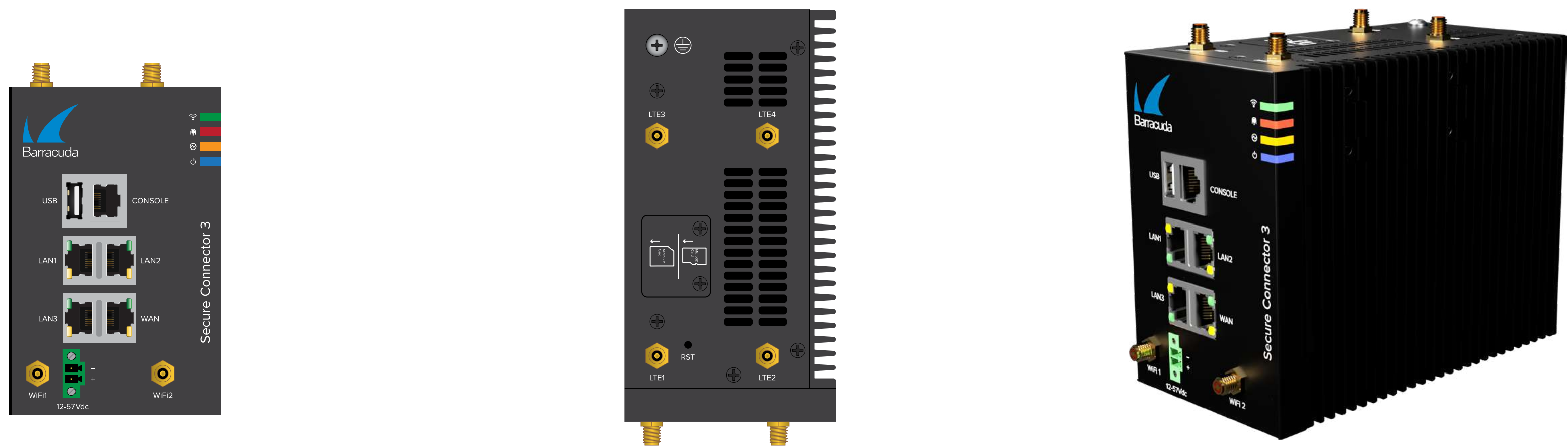

INTERFACES		
WAN copper ethernet NICs (PoE-recipient; 1 GbE)		1x
LAN copper NICs (LAN switch; 1 GbE)		3x
USB 2.0		1
Serial console		RJ45
WiFi (access point / client mode)		✓
SUPPORTED CELLULAR NETWORKS		
4G / LTE		✓
PERFORMANCE [AS OF FIRMWARE RELEASE 8.3.X]		
Firewall throughput (UDP) [Mbps]		300
WiFi AP mode throughput (UDP) [Mbps]		80
Site performance (up to) (AES-128, SHA) [Mbps] <sup>[a]</sup>		30
MEMORY		
RAM [GB]		2
MASS STORAGE		
Size On-board [GB]		8
Size Micro SD [GB]		16
SIZE, WEIGHT, DIMENSIONS (ALSO SEE PAGE 71)		
Weight appliance [lbs] / [kg]	2.42 / 1.1	
Appliance size: width x depth x height [in]	3.03 x 4.72 x 5.91	
Appliance size: width x depth x height [mm]	77 x 120 x 150	
Weight carton with appliance [lbs] / [kg]	t.b.a. / t.b.a.	
Carton size: width x depth x height [in]	t.b.a.	
Carton size: width x depth x height [mm]	t.b.a.	
Form factor		Rugged, DIN rail
HARDWARE		
Cooling		Fanless
ENVIRONMENTAL		
Noise emission [db/A]		N/A
Operating temperature [°F] / [°C]		-4 to +158 / -20 to +70
Storage temperature [°F] / [°C]		-4 to +158 / -20 to +70
Operating humidity (non-condensing)		5% to 95%

This appliance is PoE-recipient compatible and, thus, has no external power brick included. However, an external power brick can be ordered as an option.

MTBF [SYSTEM]	
MTBF [yrs.] <sup>[b]</sup>	> 5
POWER & EFFICIENCY	
AuxDC in voltage range (2-pin terminal block MC420 3.5mm) [V]	12 - 57
WAN Port PoE Voltage range [V]	37 - 54
Compatible PoE provider (PSE)	IEEE 802.3at (Type 2) PD
POWER SUPPLY (OPTIONAL)	
Power supply	Single, external
Power supply type	External brick
Power type [AC/DC]	DC
Input rating [Volts]	12-36
Max. power draw [W]	60
Max. power draw @ 12V [Amps.]	2.5
Max. heat dissipation [W]	60
Max. heat dissipation [BTU]	205
Energy efficiency [average]	> 83%
CERTIFICATIONS AND COMPLIANCE (ALSO SEE PAGE 104 FF)	
CE emissions	✓
CE electrical safety	✓
FCC emissions	✓
ROHS compliant	✓
Shock and vibration resistance	IEC 60068 IEC 60950 IEC 61000 ISTA 2A
Protection classification	IP20 standard
PACKAGING CONTENT	
Appliance	✓
Straight network cable	✓
External power brick & cables	Optional
Quick start guide	✓
1x DIN rail bracket	✓
1x 2-pin power connector	✓
2x WiFi antenna	✓
4x Cellular antenna with 1.5m cable	✓

All performance values are measured under optimized conditions and are to be considered as „up to“ values and may vary depending on system configuration and infrastructure:

- a Site performance is based on 1415 Byte UDP packets, bidirectional using BreakingPoint traffic generator.
- b MTBF according to common usage. High load on SSD and extreme environmental conditions might reduce MTBF.

Errors and omissions excepted. Specifications subject to change without notice.



# Additional hardware options

HARDWARE OPTION	F12A	F18B	F80B	F180B	F280C	F380B	F400C	F600D	F800C	F900B	F1000B
Built-in WiFi option	-	-	●	●	●	-	-	-	-	-	-
Spare power supply unit for sub-models with dual power supply	-	-	-	-	-	-	○	○	○	○	-
L-shape rack mount bracket (2x)	○	○	○	●	●	●	●	●	●	●	●
Rail kit	-	-	-	-	-	○	○	●	●	●	●
USB modem	○	○	○	○	○	○	○	○	○	○	○

○ optional    ● included

## Built-in Wi-Fi option

Barracuda CloudGen Firewall appliances F80B, F180B, and F280C offer built-in Wi-Fi.



Figure 14 - Rear view on model F80B with Wi-Fi antennas mounted

ITEM	SPECIFICATION
Standards	802.11b/g/n
Operating frequency	802.11b/g/n ISM Band: 2.412 ~ 2.4835 GHz
Modulation	802.11b: DSSS (DBPSK, DQPSK, CCK)
	802.11g: OFDM (BPSK, QPSK, 16-QAM, 64-QAM)
	802.11n: OFDM (BPSK, QPSK, 16-QAM, 64-QAM)
Output power	802.11b: 17dBm ± 2dBm
	802.11g: 16dBm ± 2dBm
	802.11gn HT20: 15dBm ± 2dBm@MCS7
	802.11gn HT40: 14dBm ± 2dBm@MCS7
Receive sensitivity	802.11b: ≤ -85dBm@11Mbps
	802.11g: ≤ -76dBm@54Mbps
	802.11gn HT20: ≤ -75dBm@MCS7
	802.11gn HT40: ≤ -72dBm@MCS7
Wireless security	64/128-bits WEP
	WPA
	WPA2

## Spare power supply unit

The spare power supply unit is available for model featuring standard dual power supply, i.e., F400C.F20, F600D.C20, F600D.F20, F600D.E20, all F800C and F900B sub-models.

## Barracuda L-shape rack mount bracket

The L-shape rack mount brackets are used for mounting desktop models in 1U Standard 19” rack slots. For CloudGen Firewall F12A, F18B, and F80B, the brackets are an optional item and, thus, to be ordered separately.

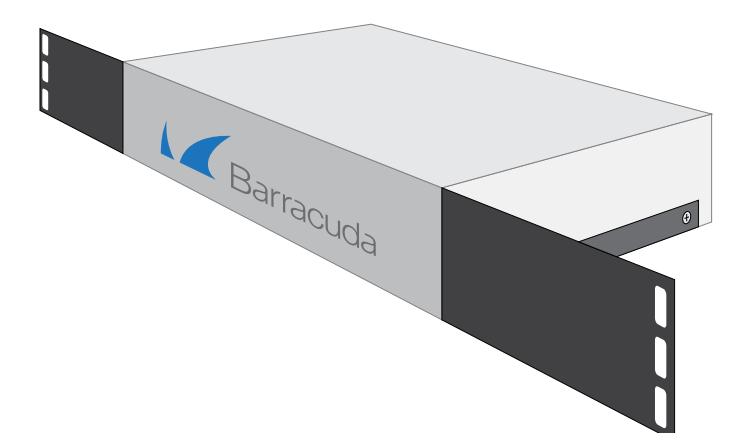



## USB modem

Especially for remote sites a USB modem is a cost effective, rapidly deployable and ultra-reliable WAN backup solution which can protect businesses and organizations against outages caused by accidental cable or fiber link cuts during construction, moves or maintenance work.

### Who can benefit from Barracuda USB modems?

- Enterprises looking for a cost effective secondary link in order to quickly increase total overall bandwidth and to reduce traffic volume on the primary link
- Enterprises relying on high quality WAN backup and WAN connectivity for business critical traffic
- Branch offices and remote sites looking for a cost effective alternative to earth bound uplinks
- Branch offices and remote sites looking to bridge the gap until cable connections become available
- Branch offices and remote sites residing in areas without a good selection of affordable or reliable Internet uplinks
- Construction sites, retail, rapid deployments, and portable businesses requiring quick access to Internet

MODEM M40	
Region	EMEA / APAC
<b>PERFORMANCE</b>	
Download / Upload	up to 150 Mbit/s / up to 50 Mbit/s
<b>SUPPORTED FREQUENCIES</b>	
LTE	800/850/900/1800/2100/2600 MHz
UTMS/HSPA/HSPA+	850/900/1900/2100 MHz
GSM	850/900/1800/1900 MHz
<b>ENVIRONMENTAL DATA, QUALITY, AND RELIABILITY</b>	
Operating temperature	-40 to 85 °C / -40 to 185 °F
RoHS compliant	lead-free
Manufactured in	ISO/TS 16949 cert. production sites
<b>ELECTRICAL DATA</b>	
Power supply DC	3.0 to 3.6 V
Power consumption	Idle: 1.8 mA / LTE max power: 815 mA
Certifications and approvals	FCC, CE, RED (R&TTE) RCM / NCC / KC / Giteki / Softbank

### Note:

Barracuda cannot guarantee signal reception. In case your server rooms are located in a basement or in a place with insufficient signal reception make sure that the signal quality is sufficient, especially prior to purchasing large quantities. SIM card is not included and has to be obtained through a mobile phone provider.



# CloudGen Firewall F93A.R

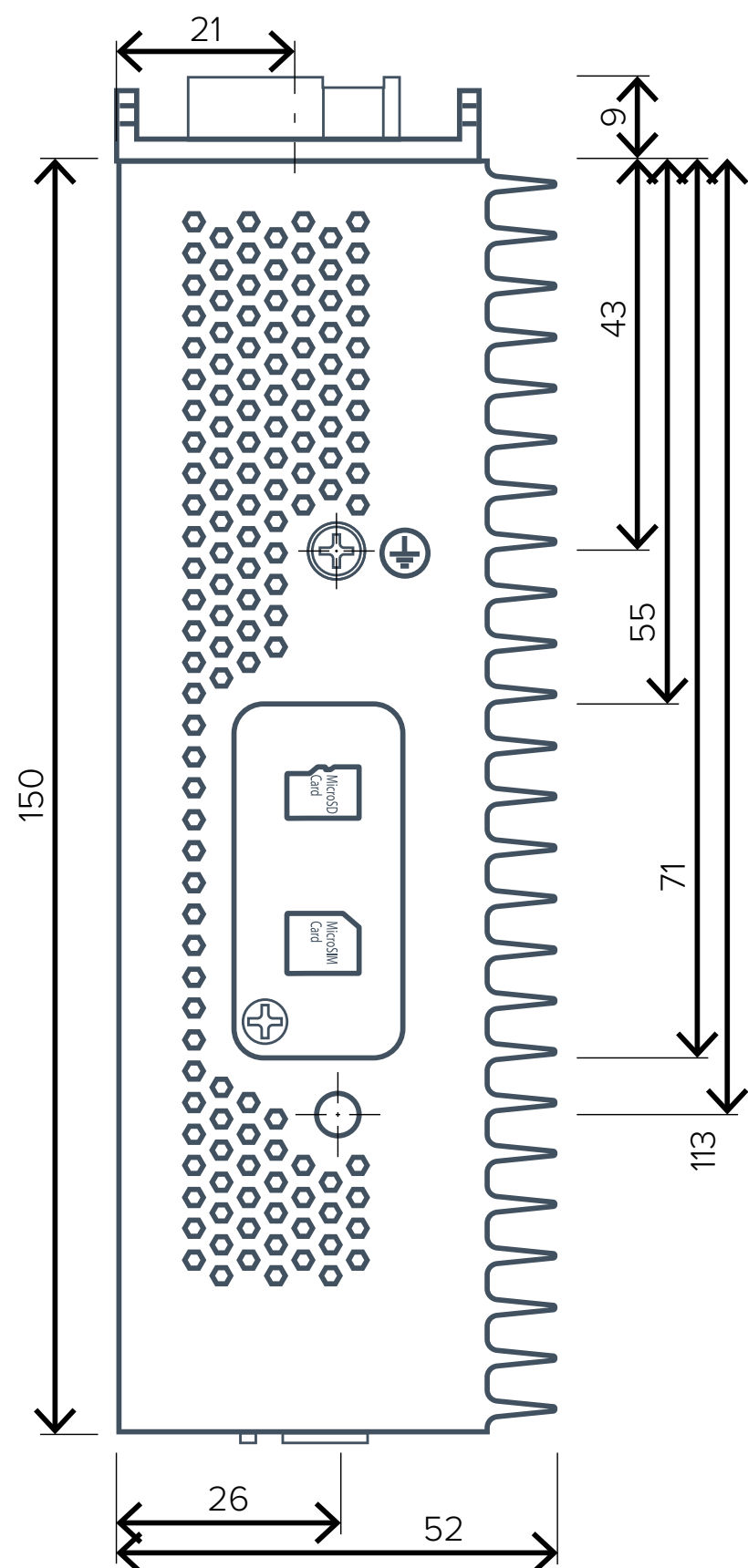
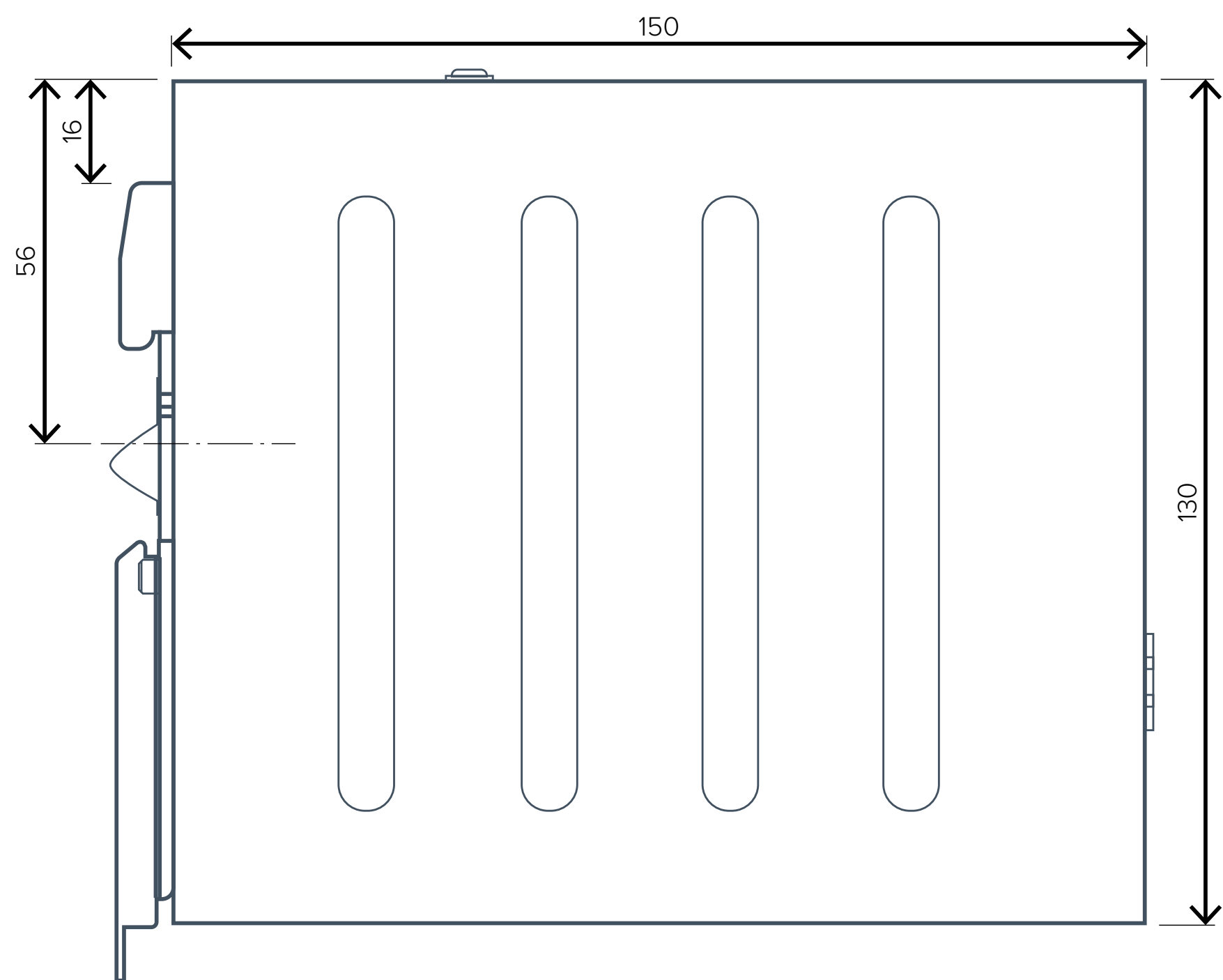
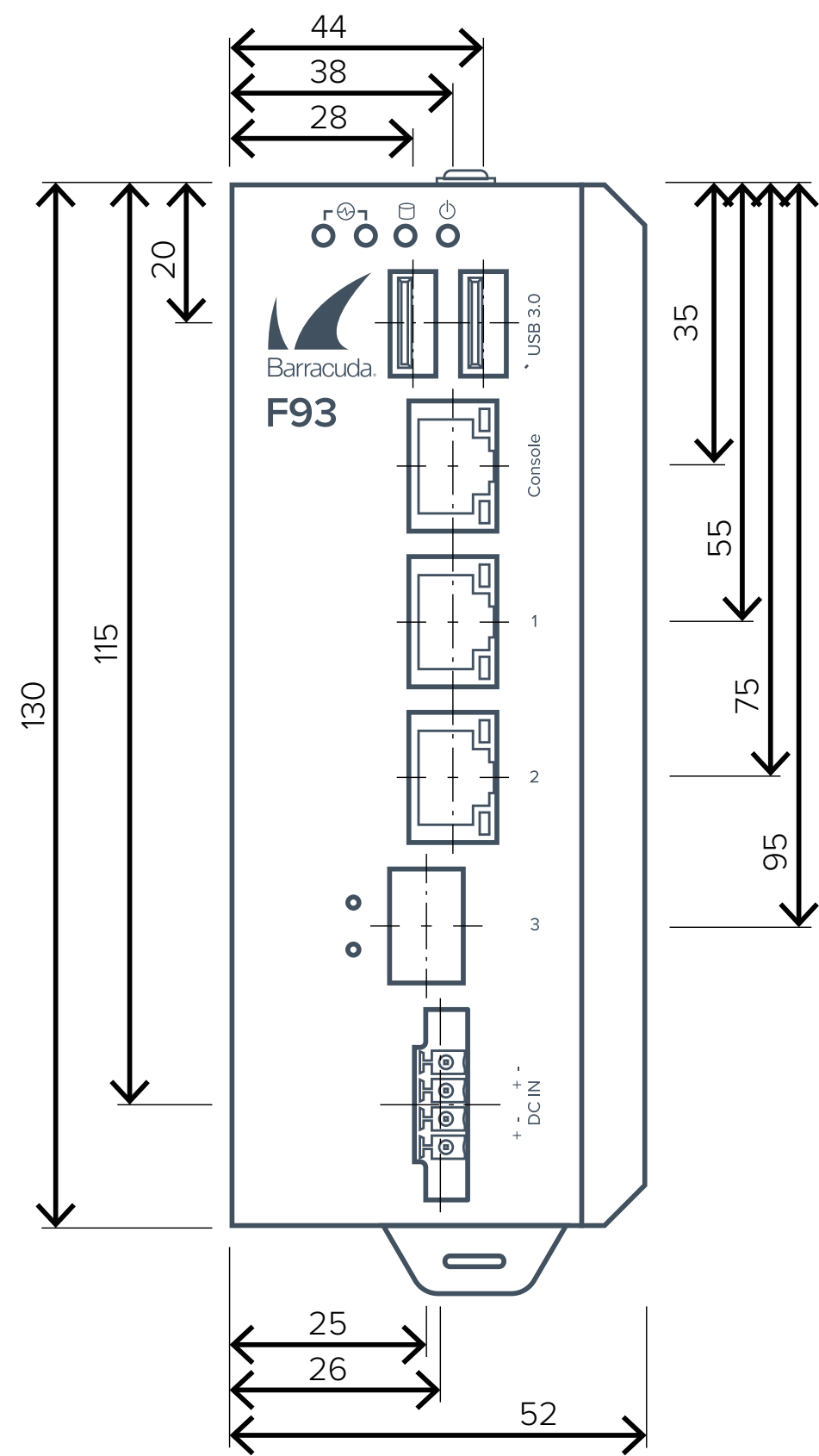

No scale illustration.  
All dimensions in mm.



# CloudGen Firewall F193A.R

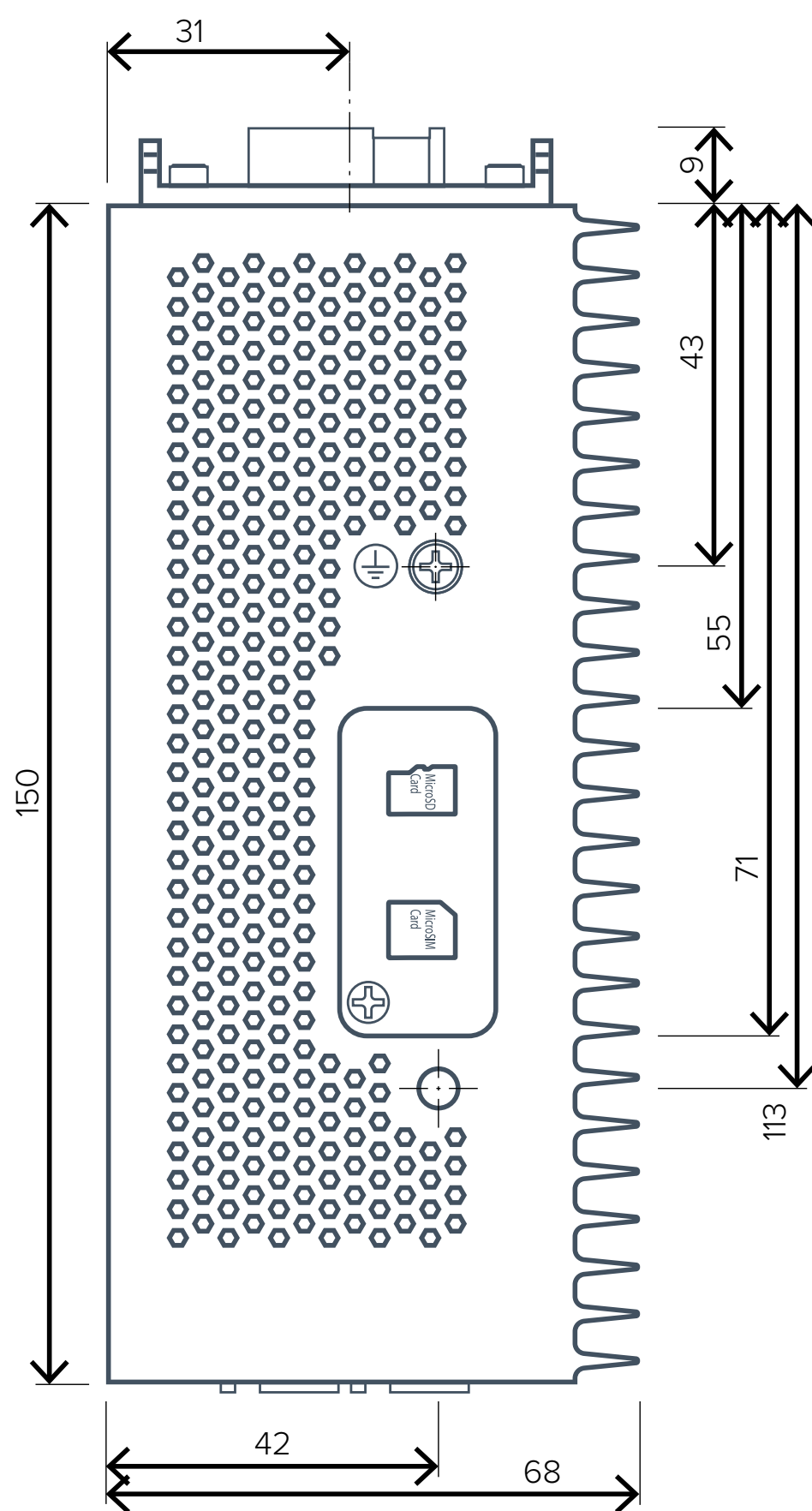
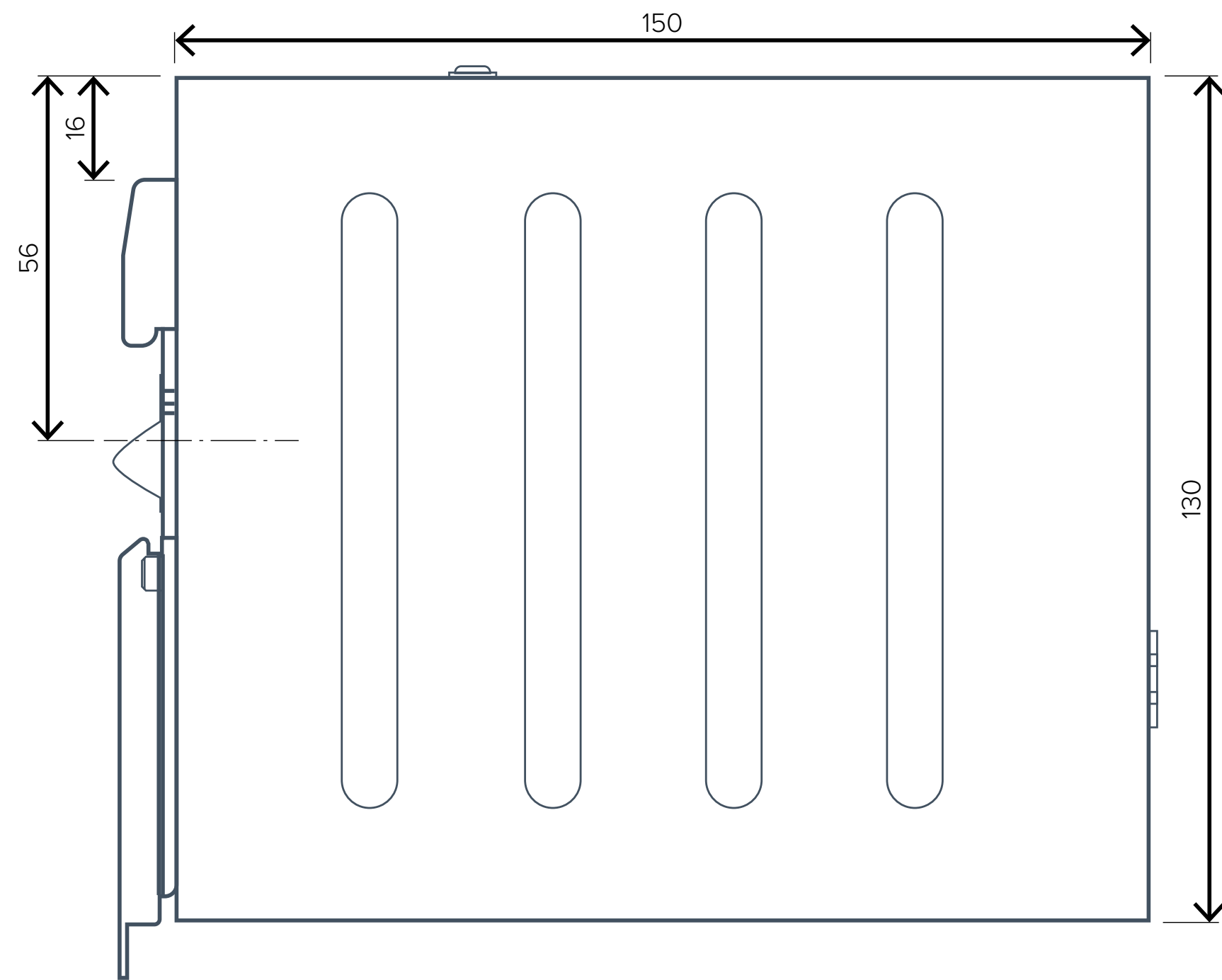
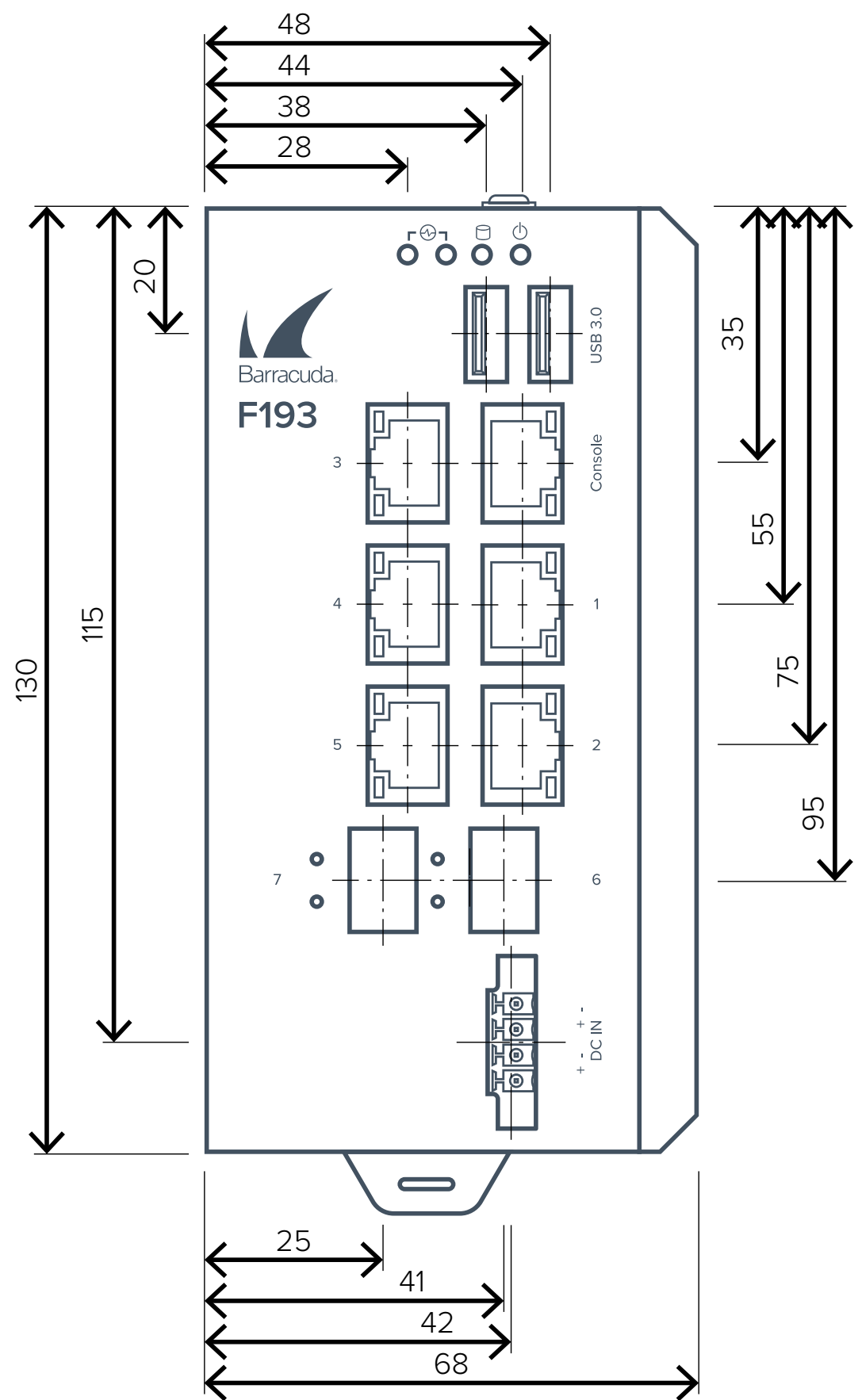

No scale illustration.  
All dimensions in mm.



# Secure Connector 20

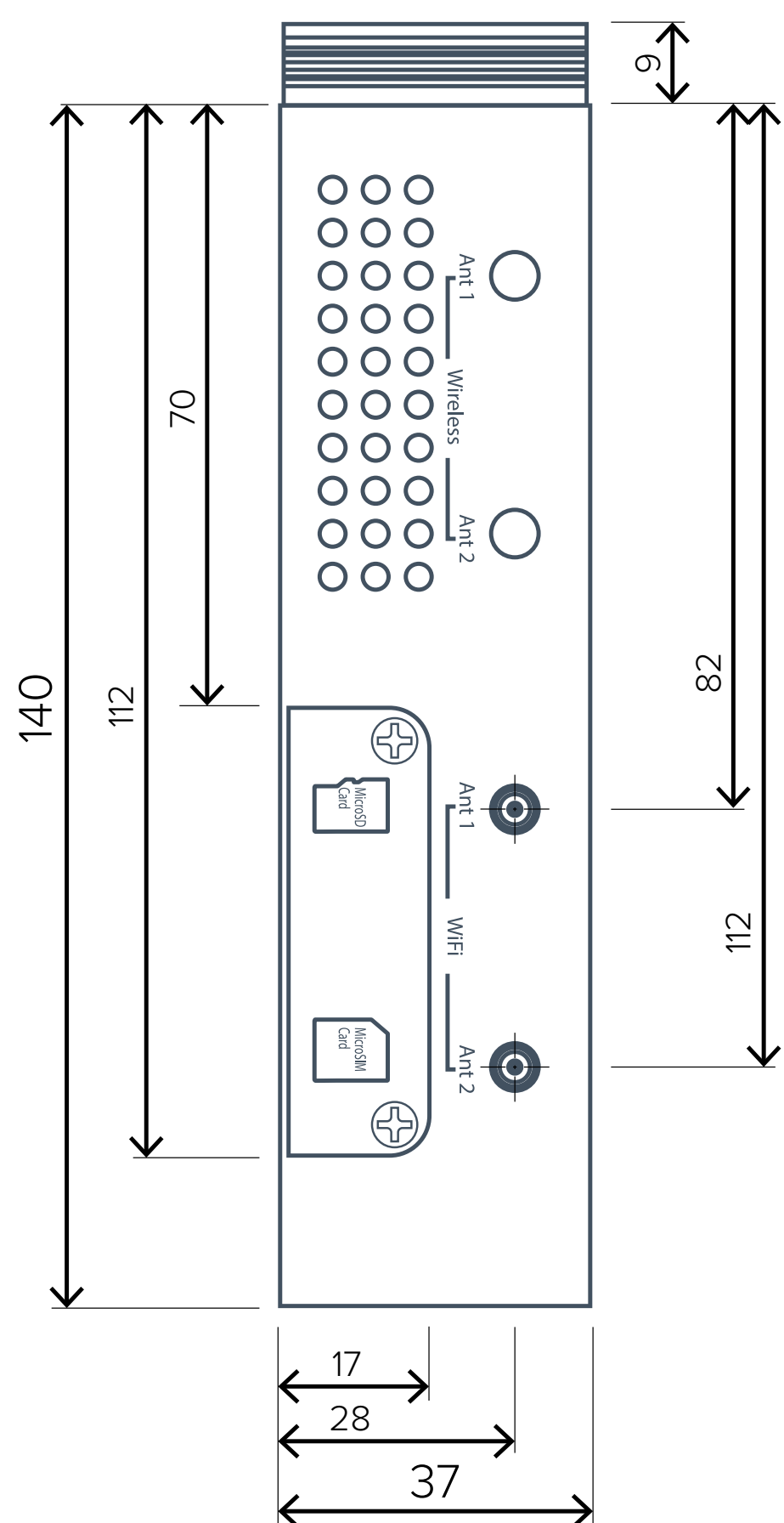
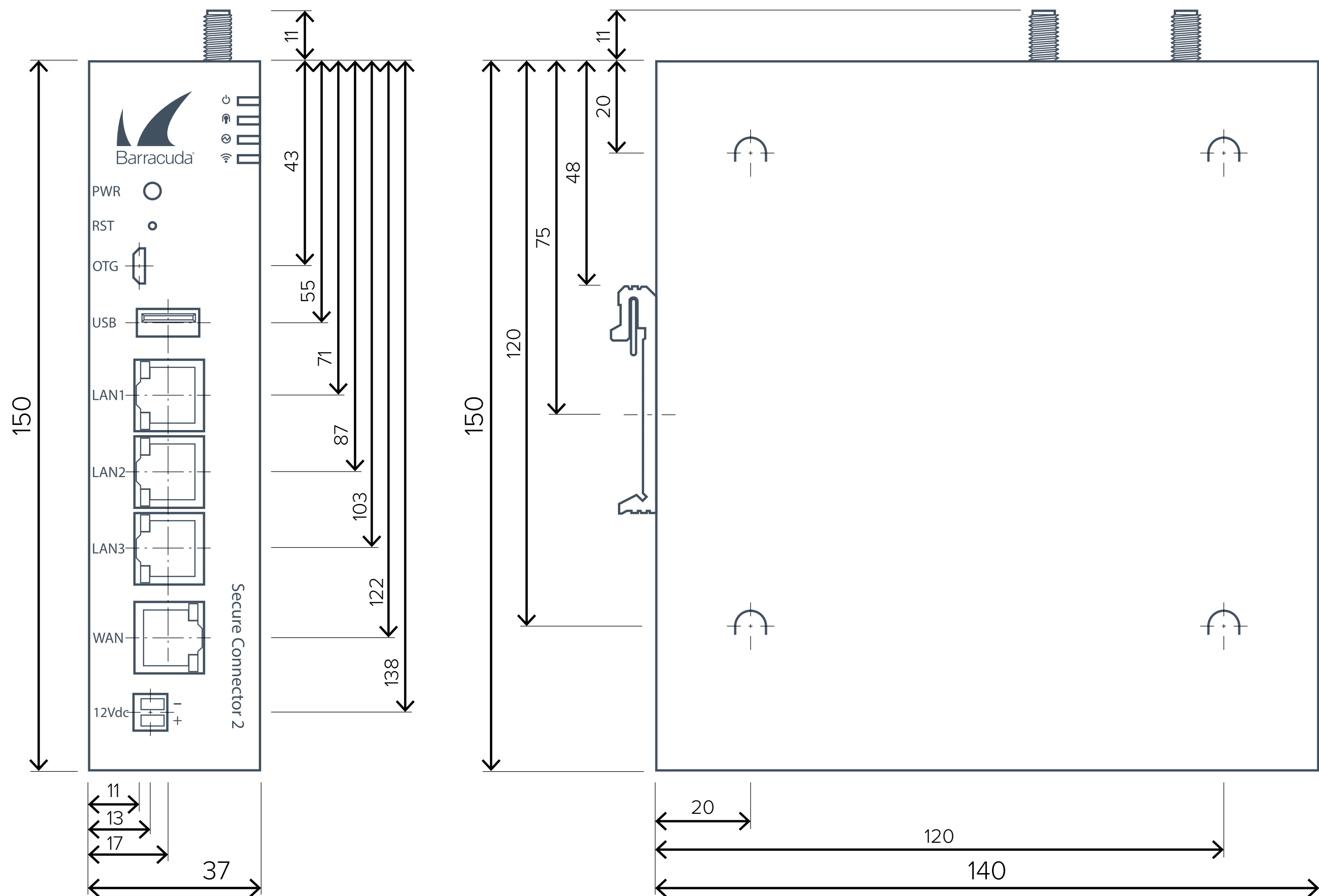

No scale illustration.  
All dimensions in mm.



# Secure Connector 21

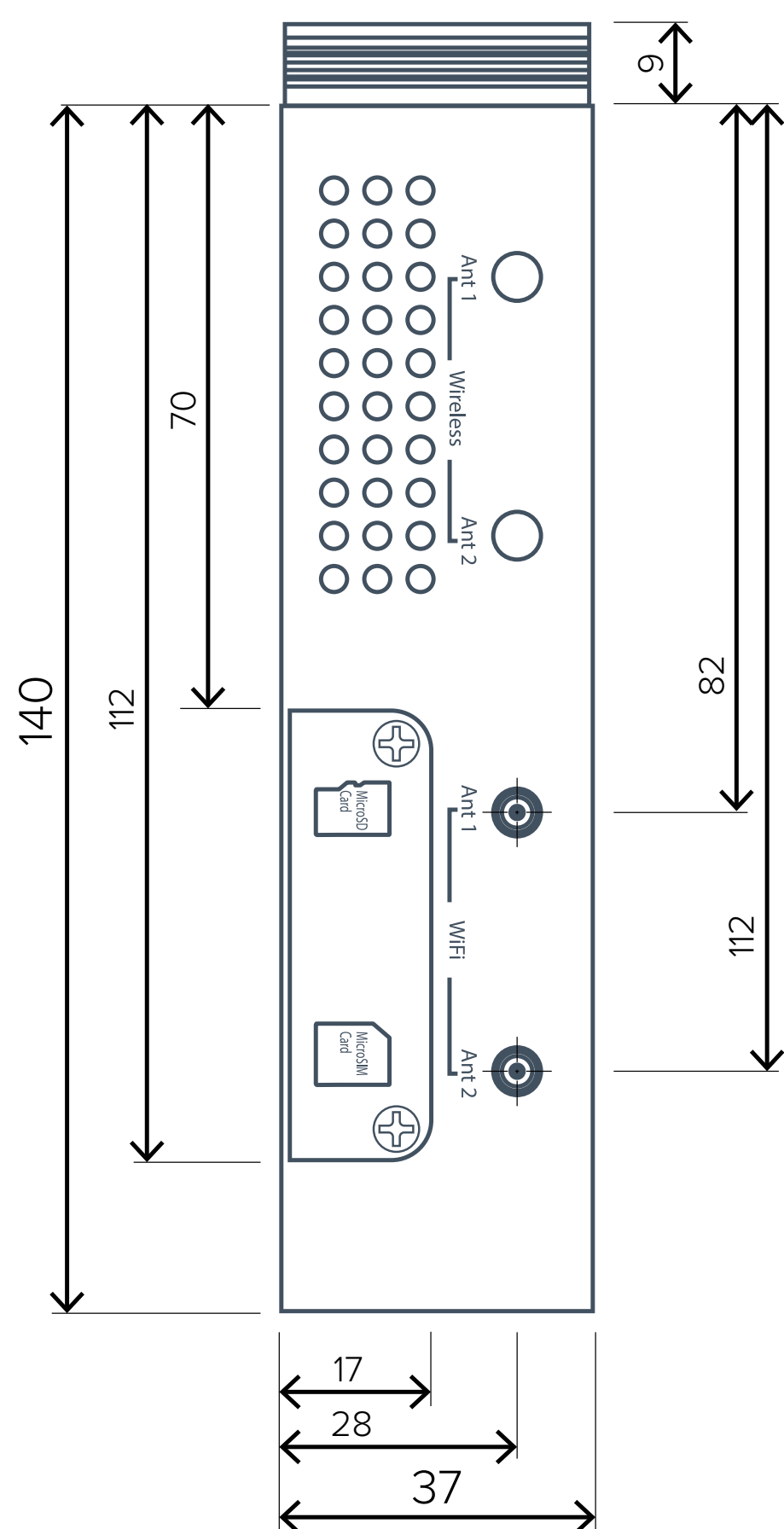
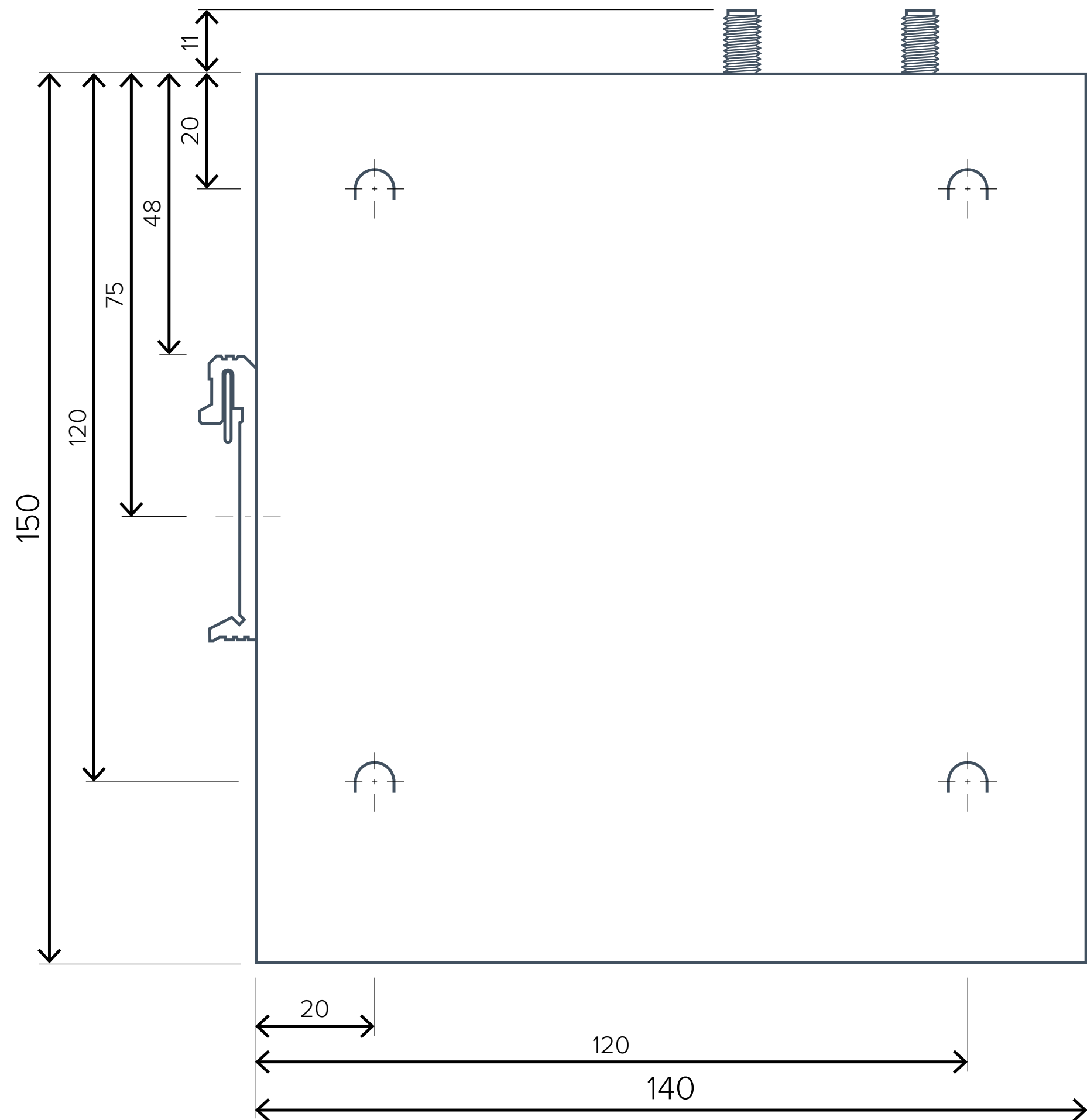
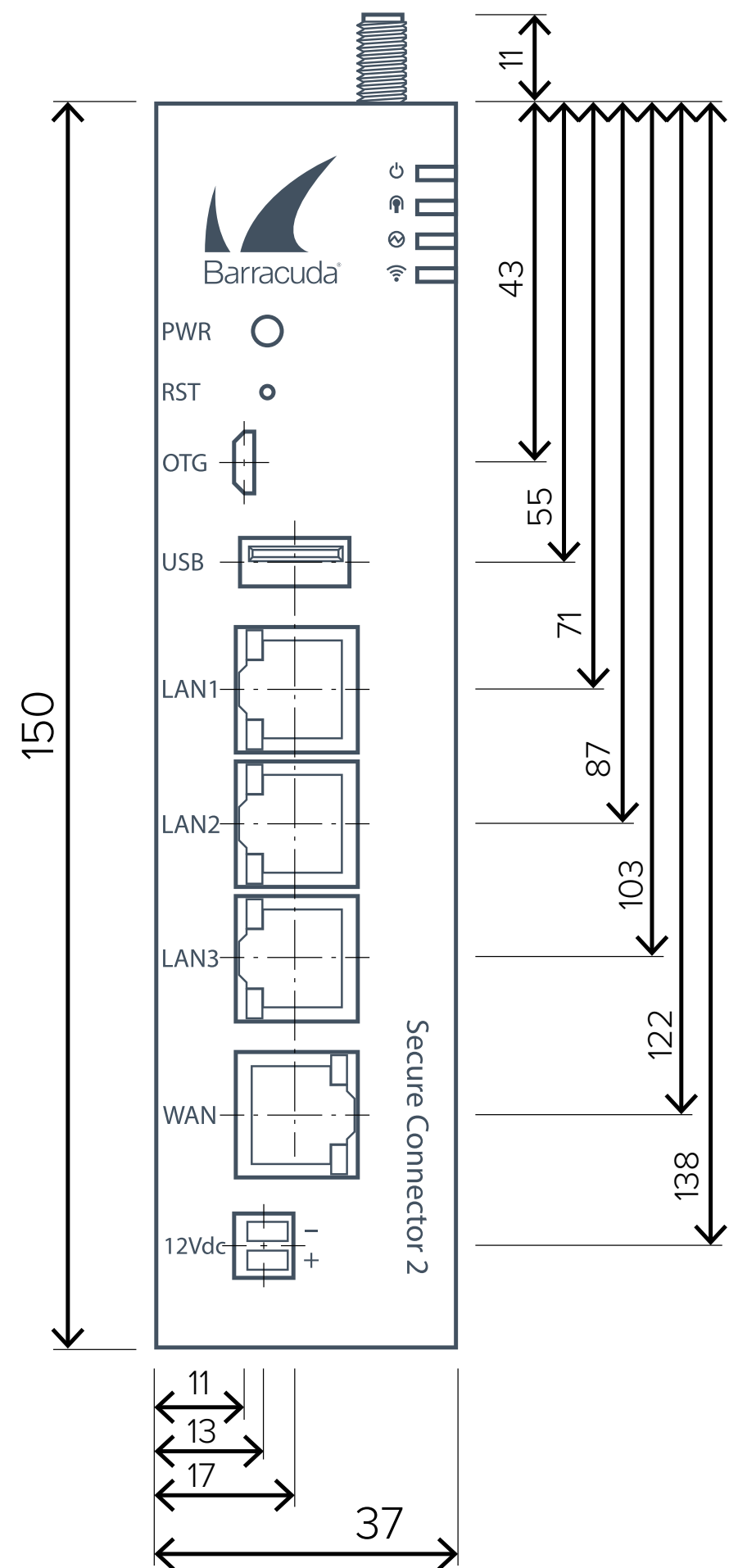

No scale illustration.  
All dimensions in mm.



# Secure Connector 24

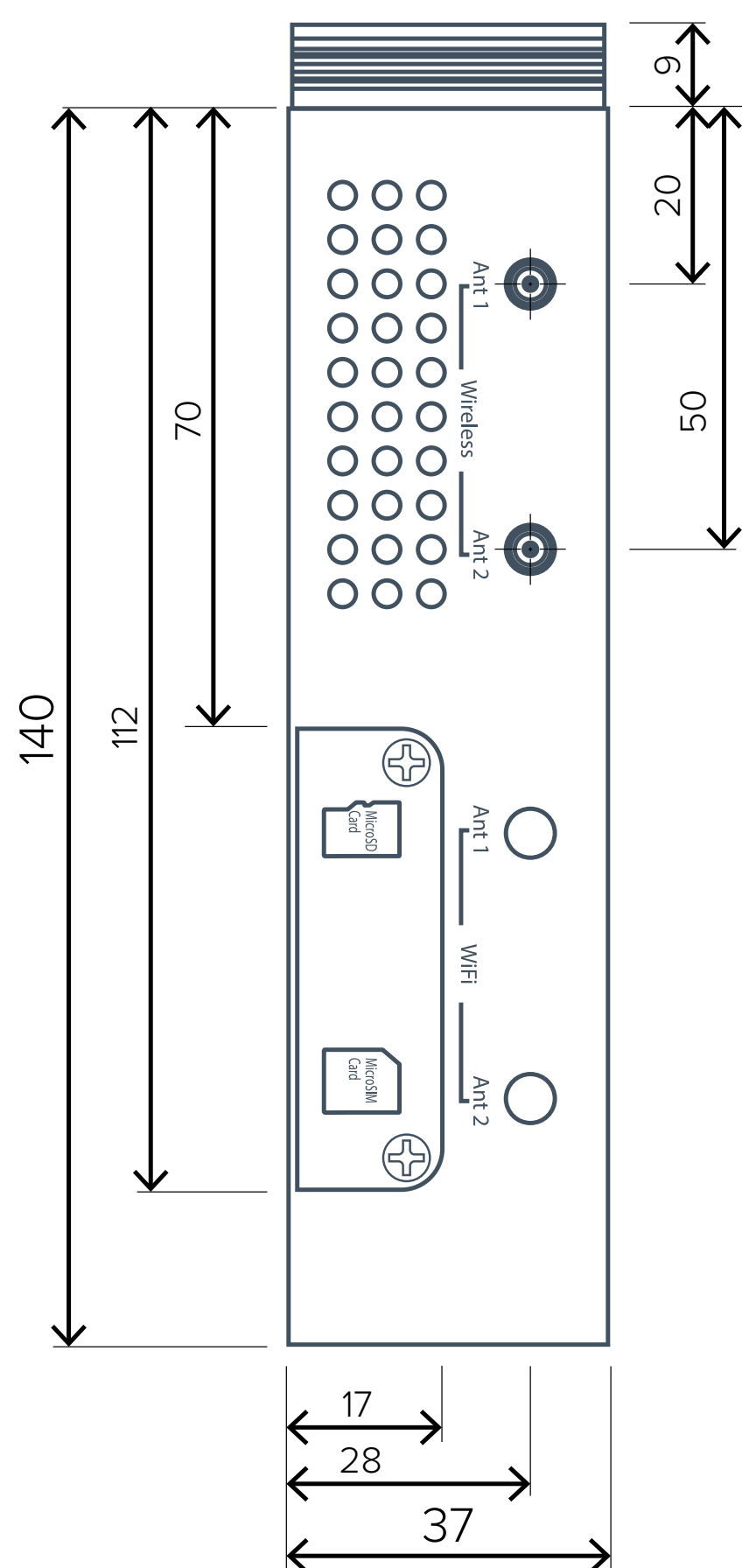
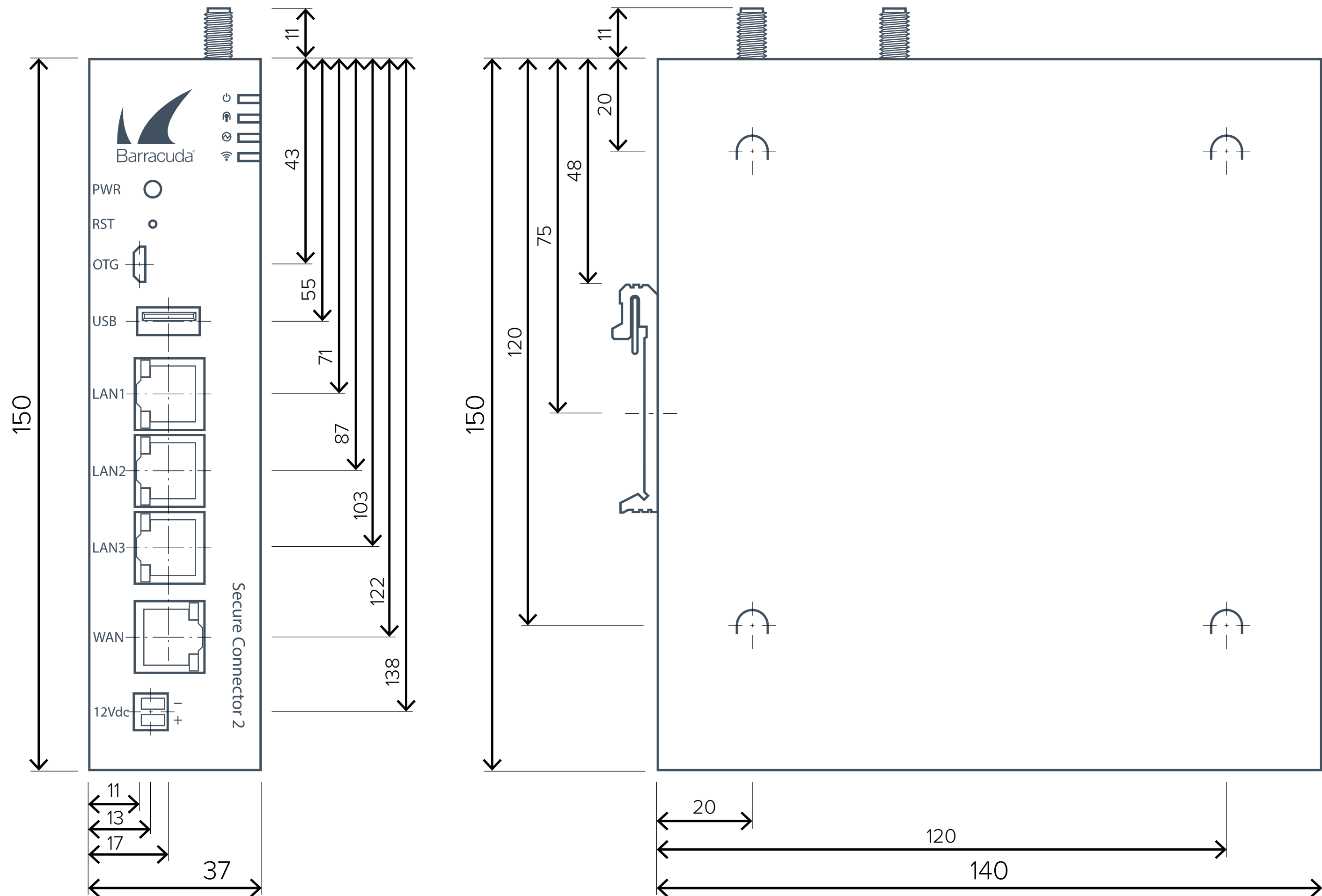

No scale illustration.  
All dimensions in mm.



# Secure Connector 25

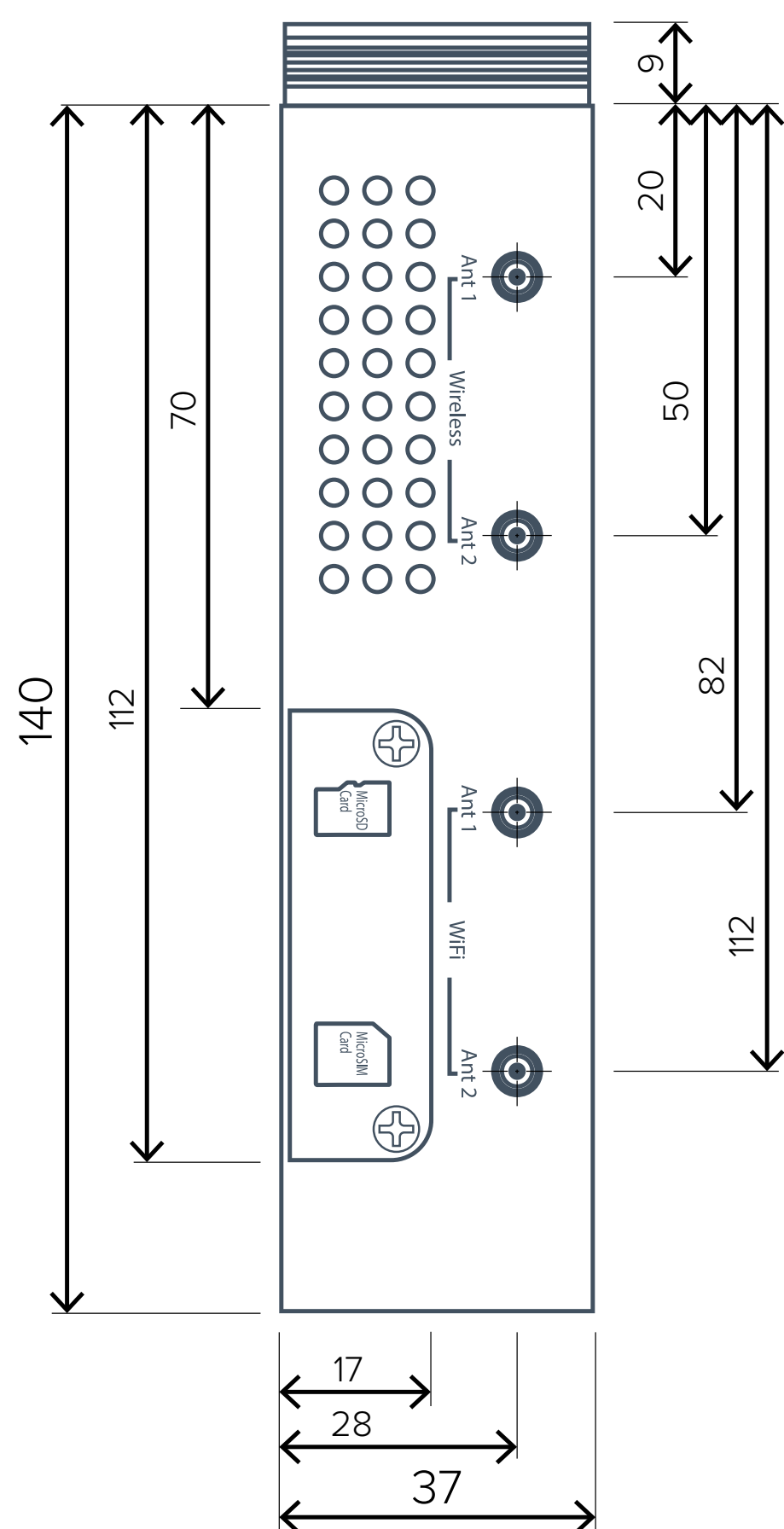
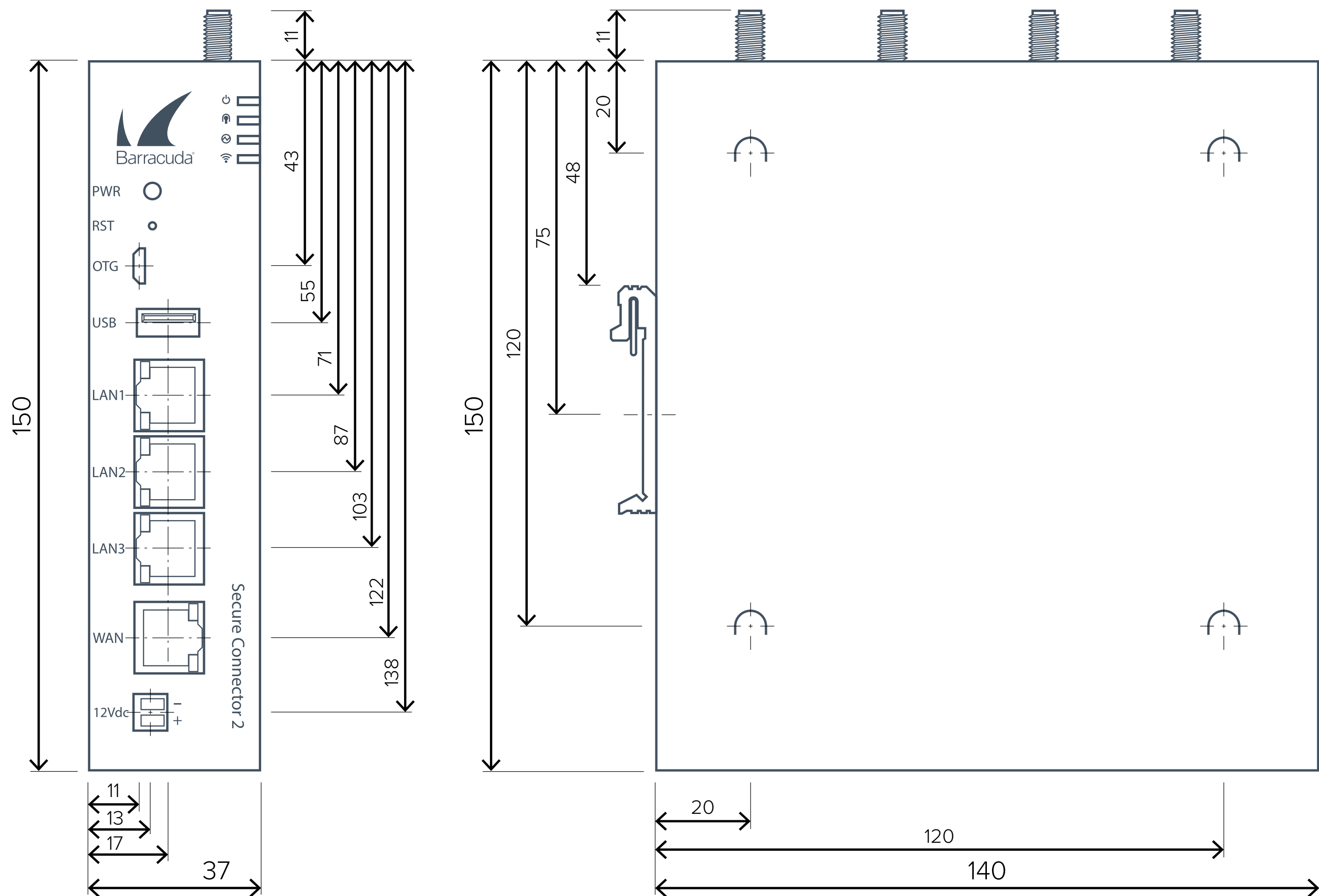

No scale illustration.  
All dimensions in mm.



# Secure Connector 30

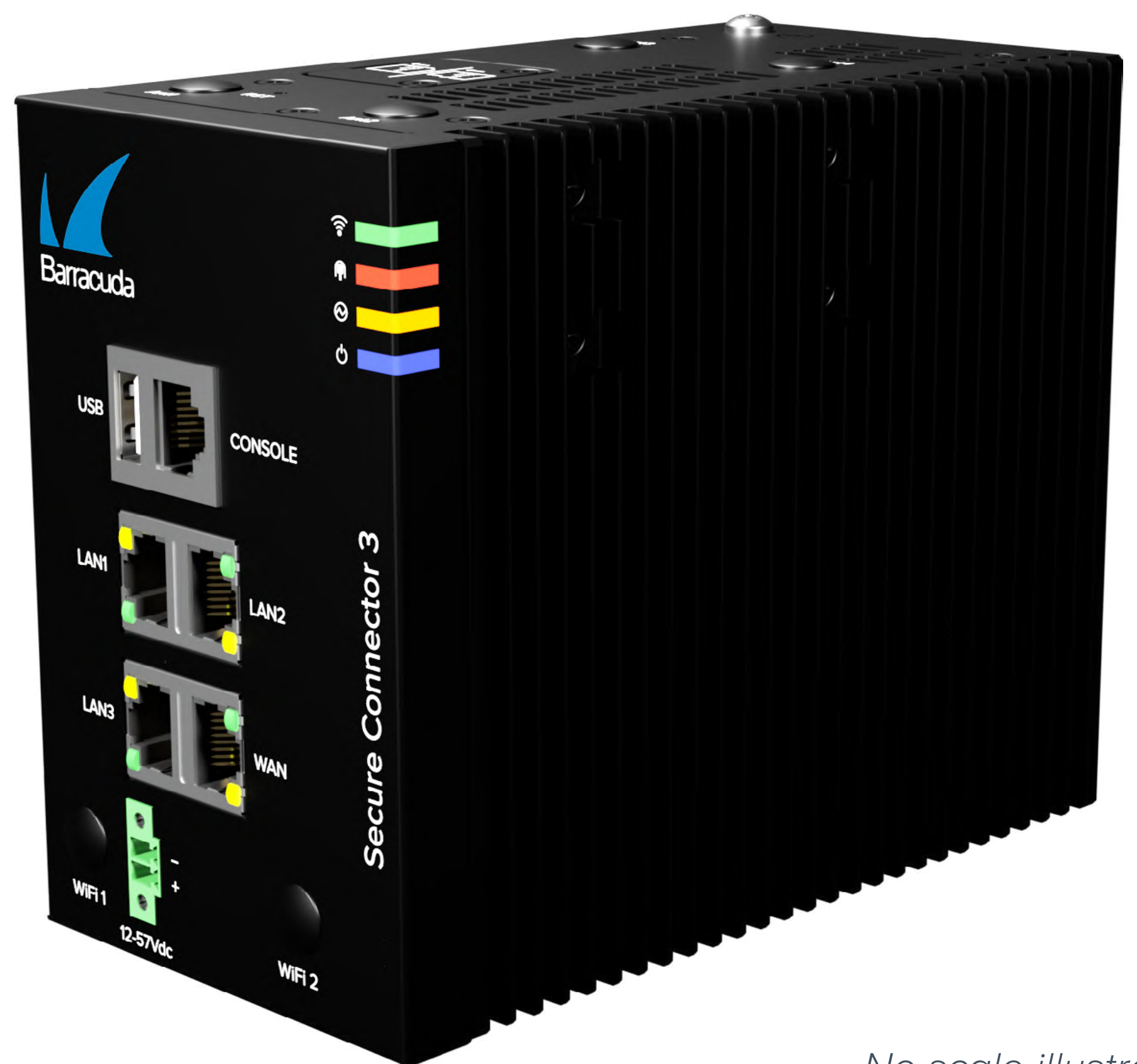
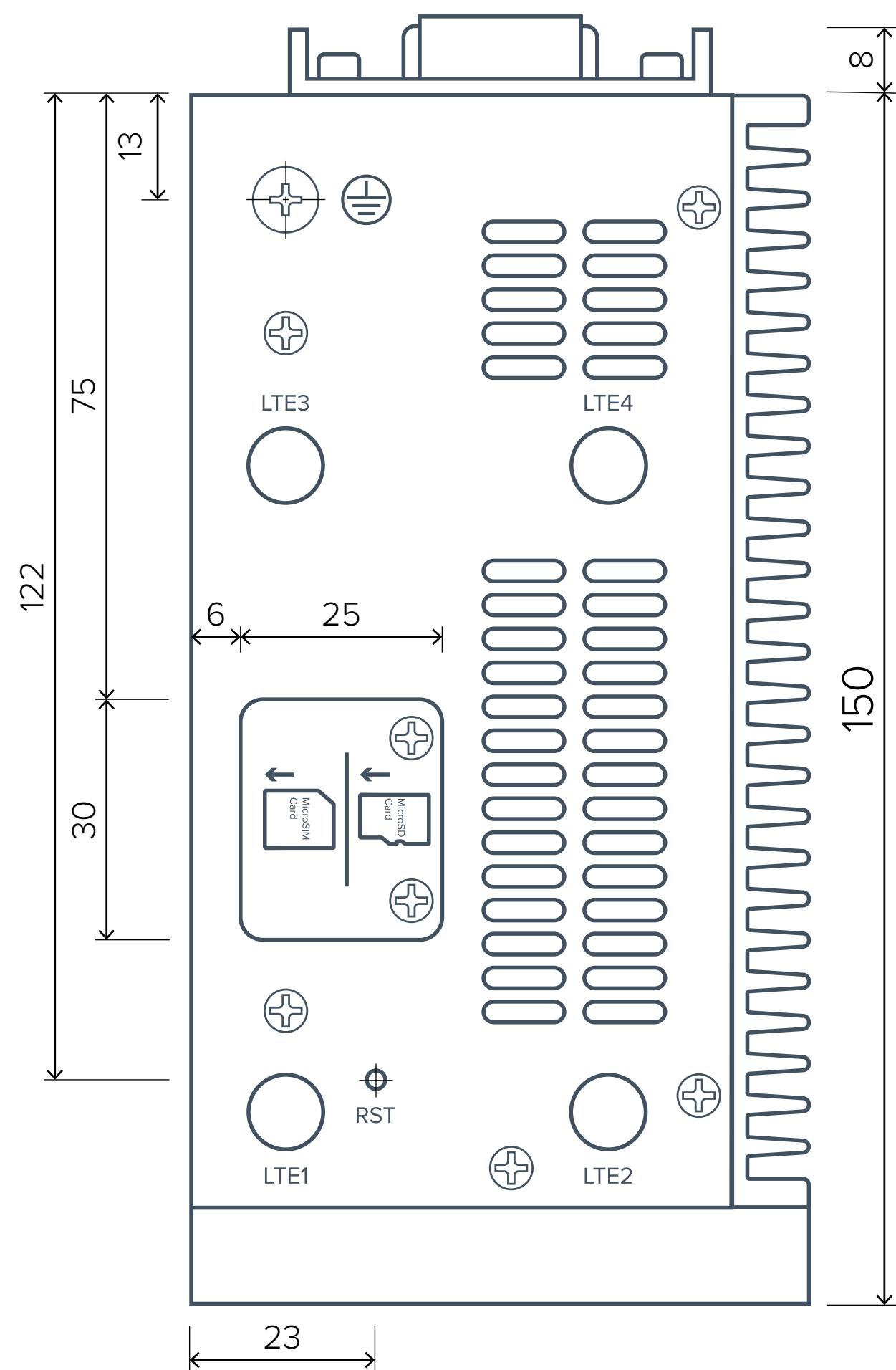
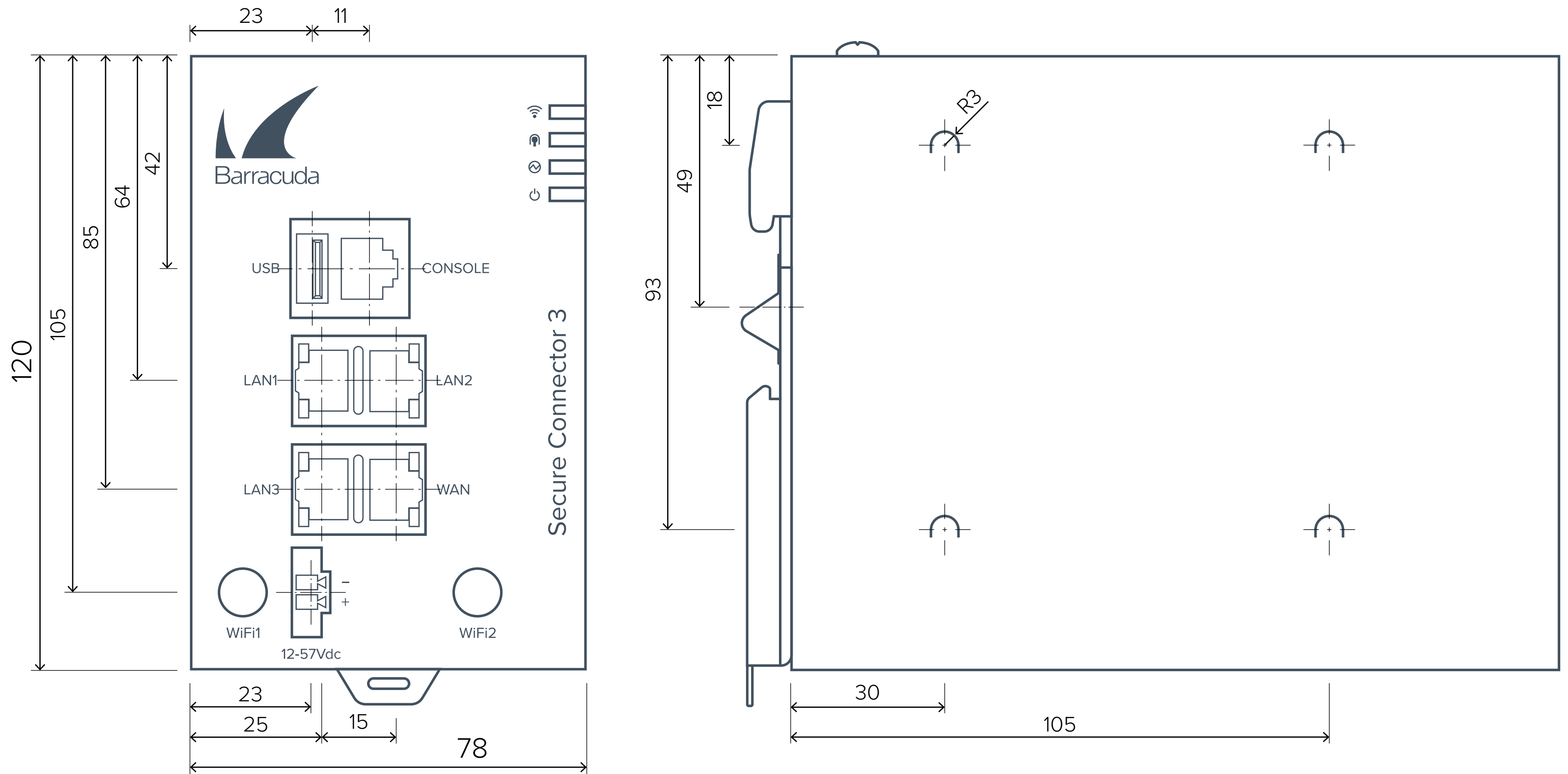

No scale illustration.  
All dimensions in mm.



# Secure Connector 31

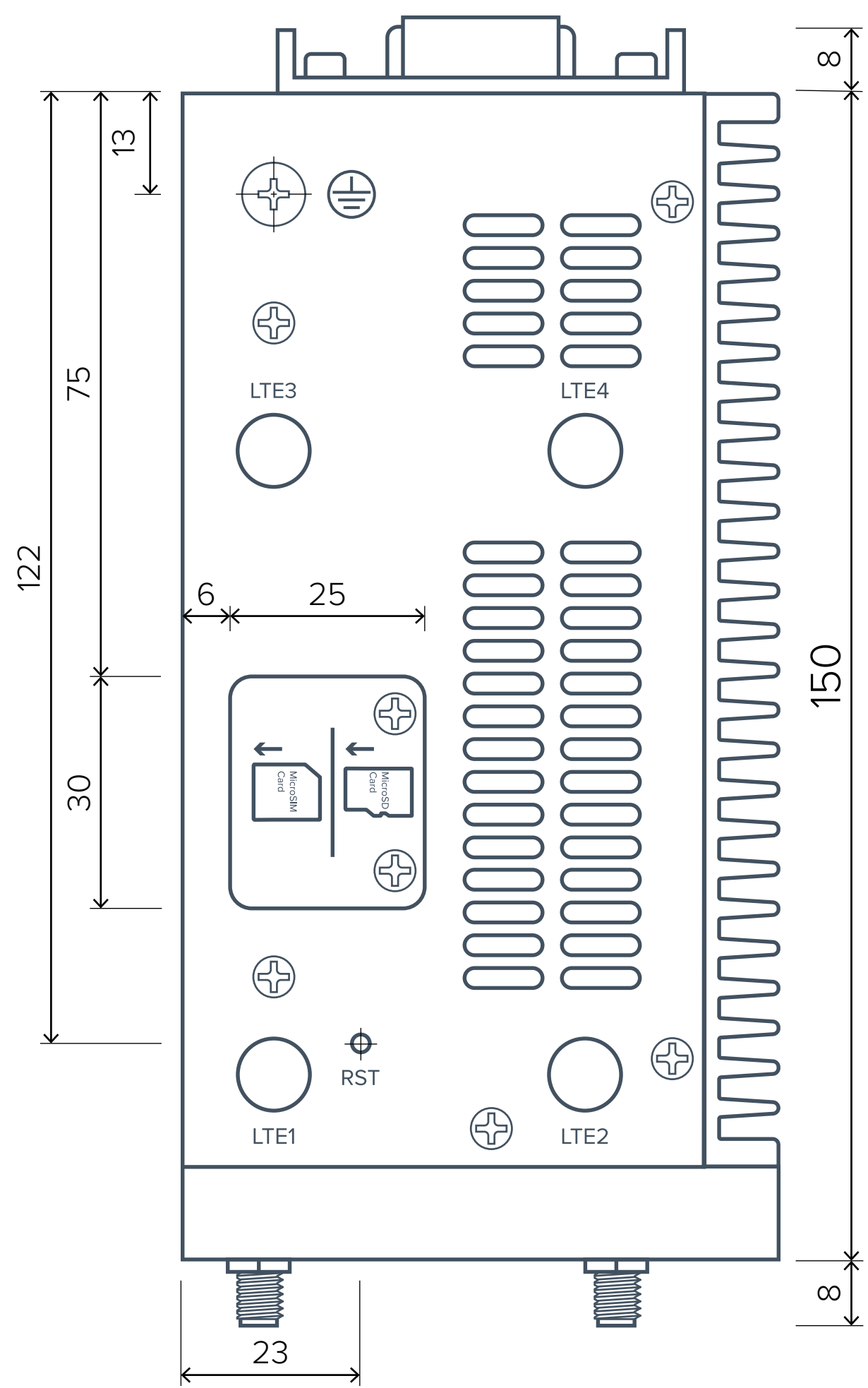
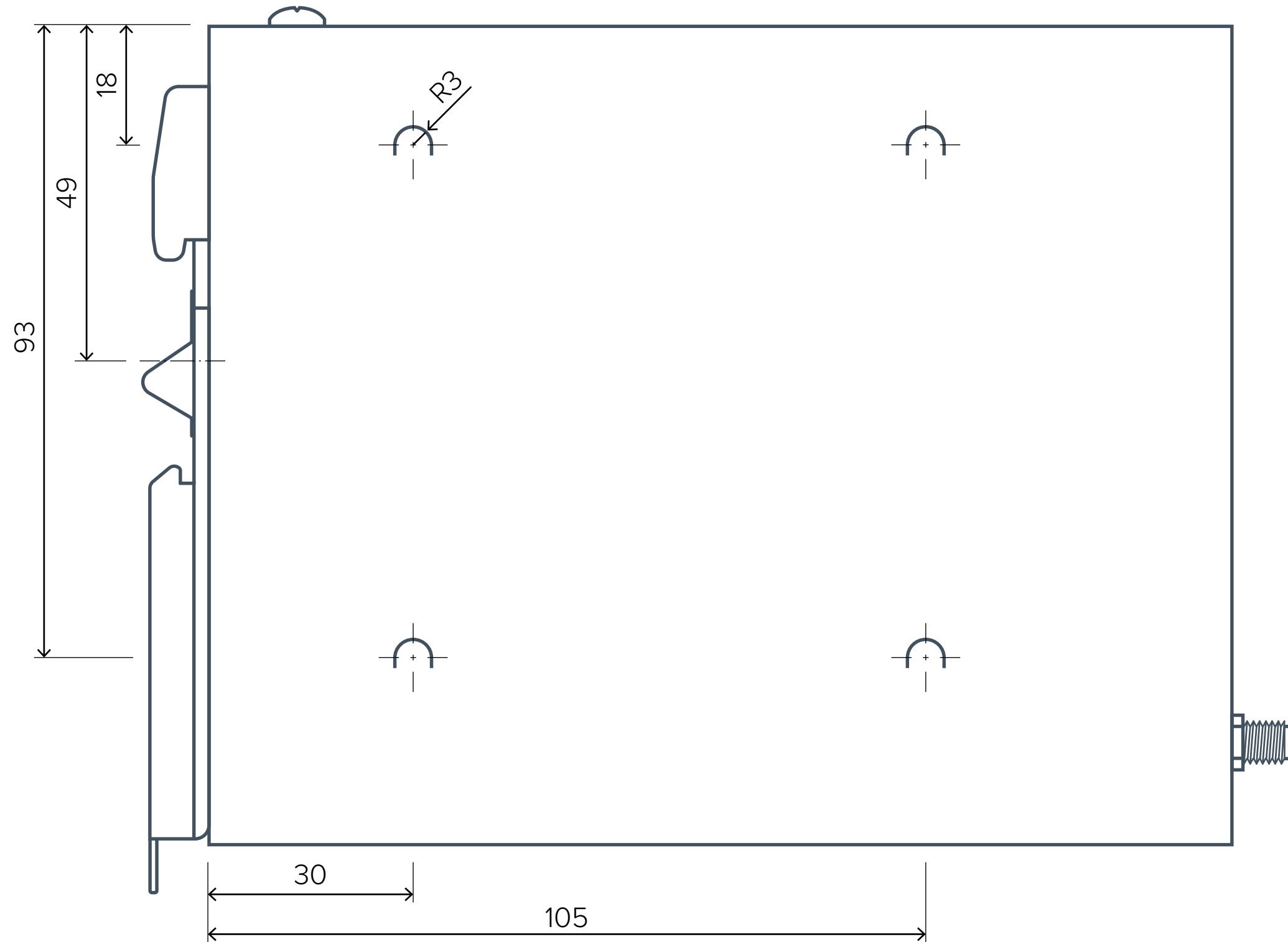
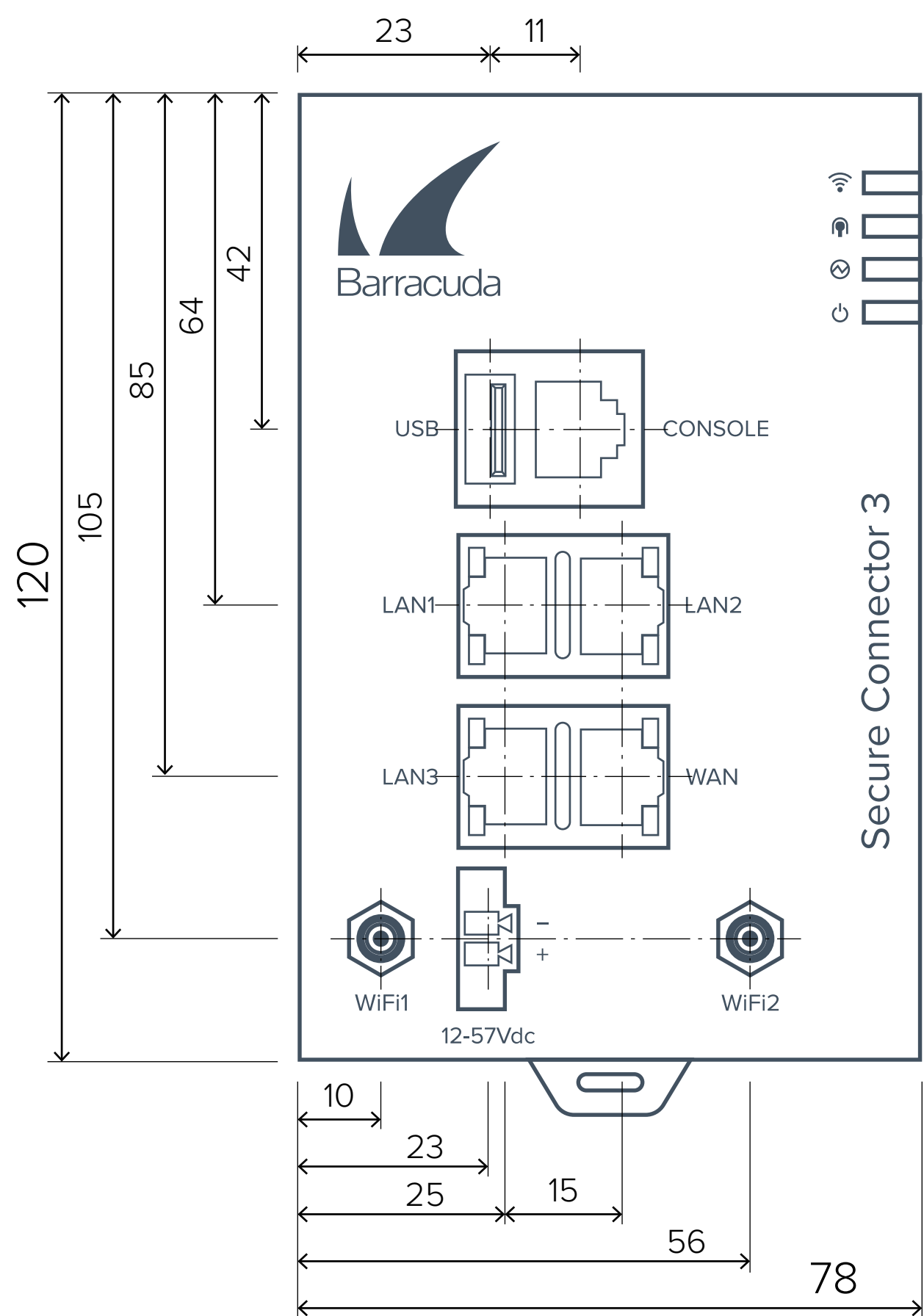

No scale illustration.  
All dimensions in mm.



# Secure Connector 34

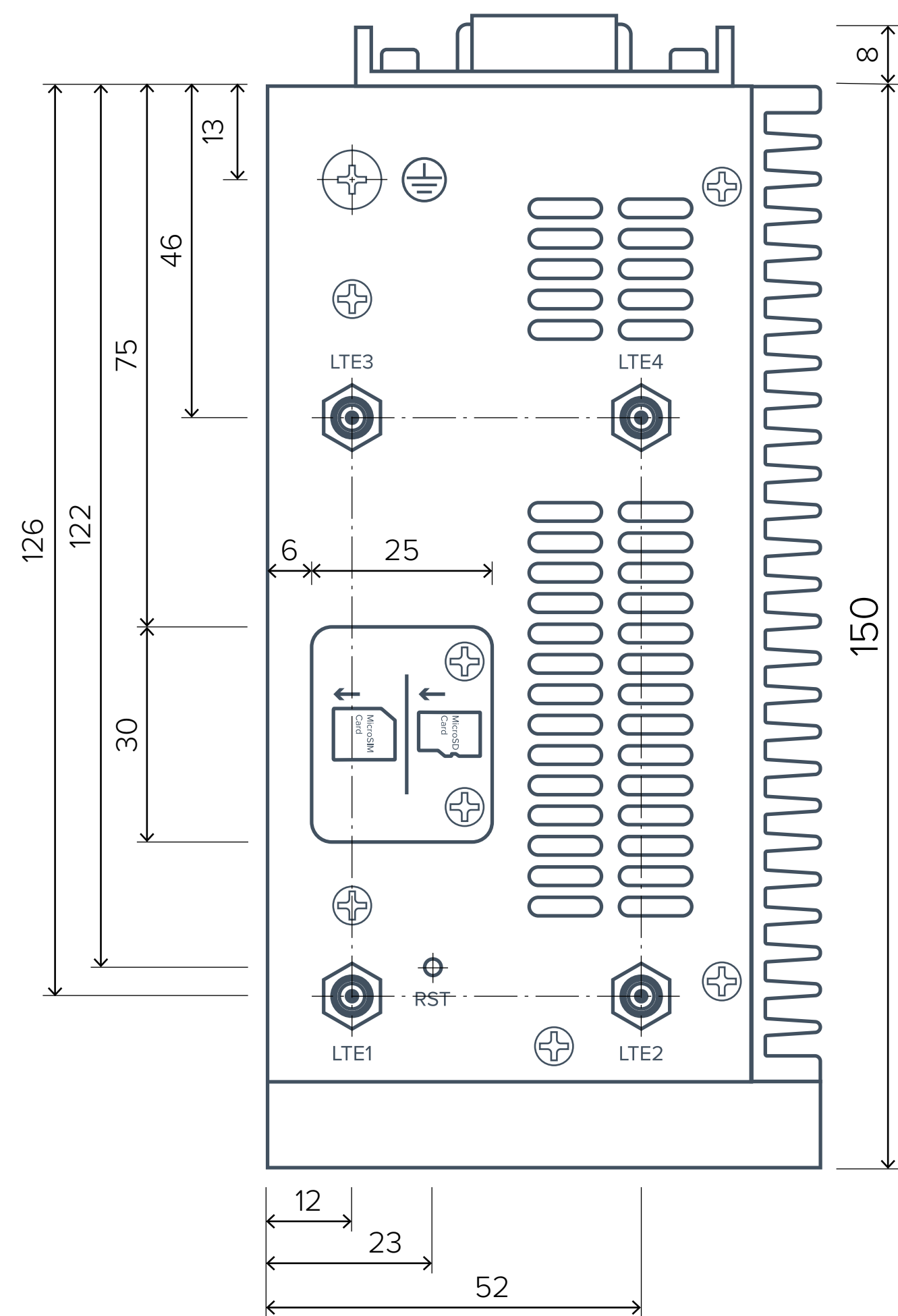
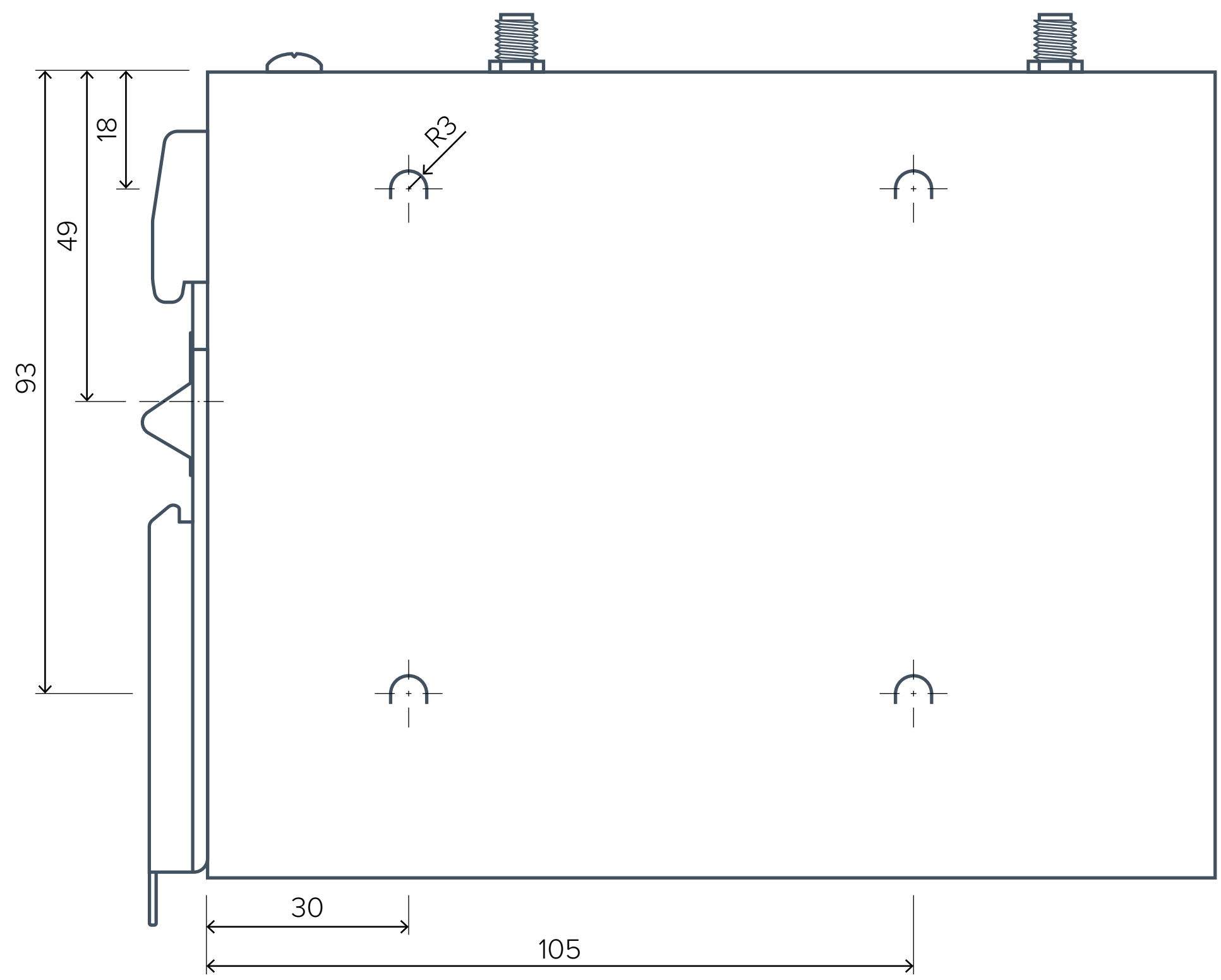
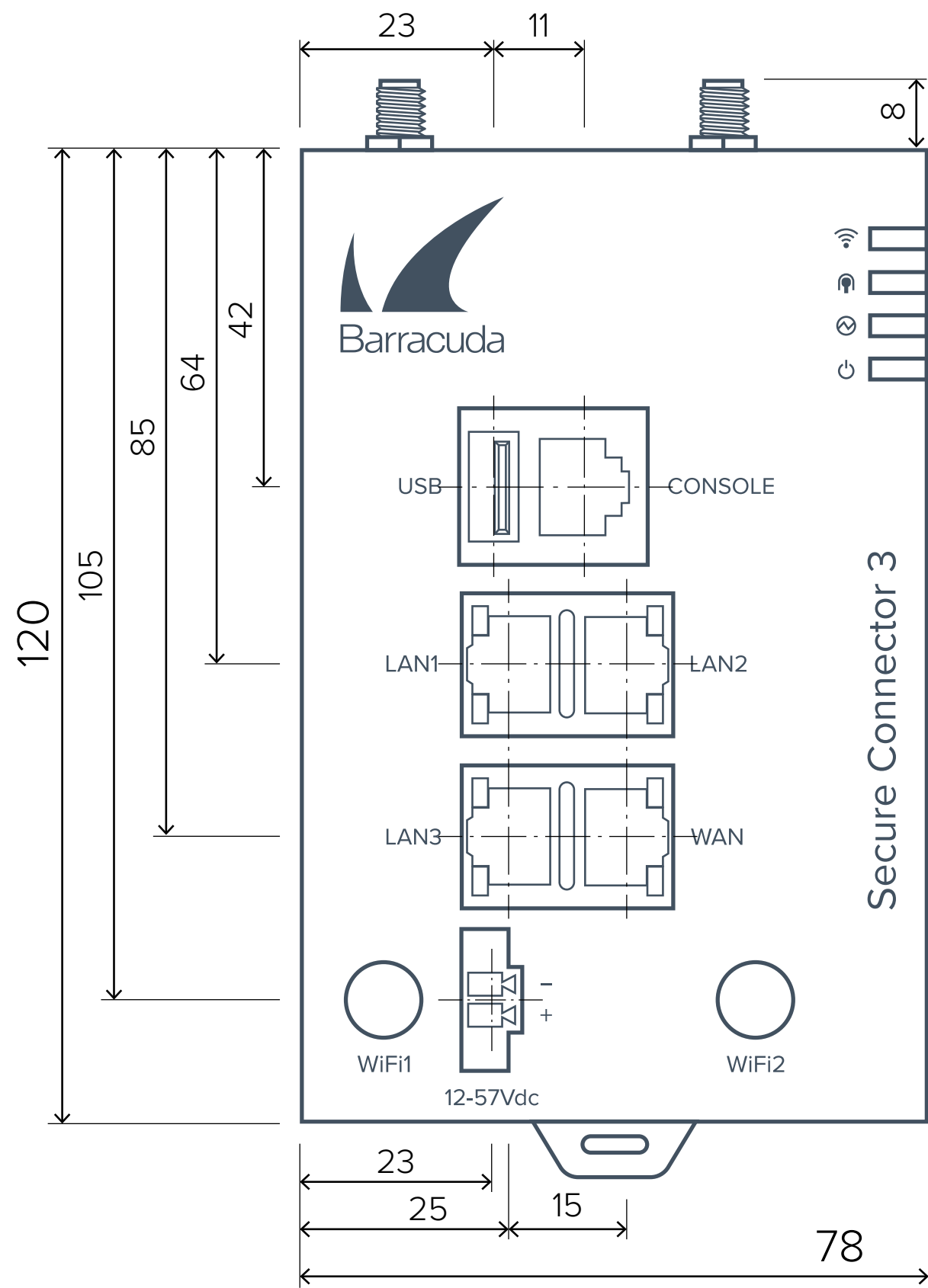

No scale illustration.  
All dimensions in mm.



# Secure Connector 35

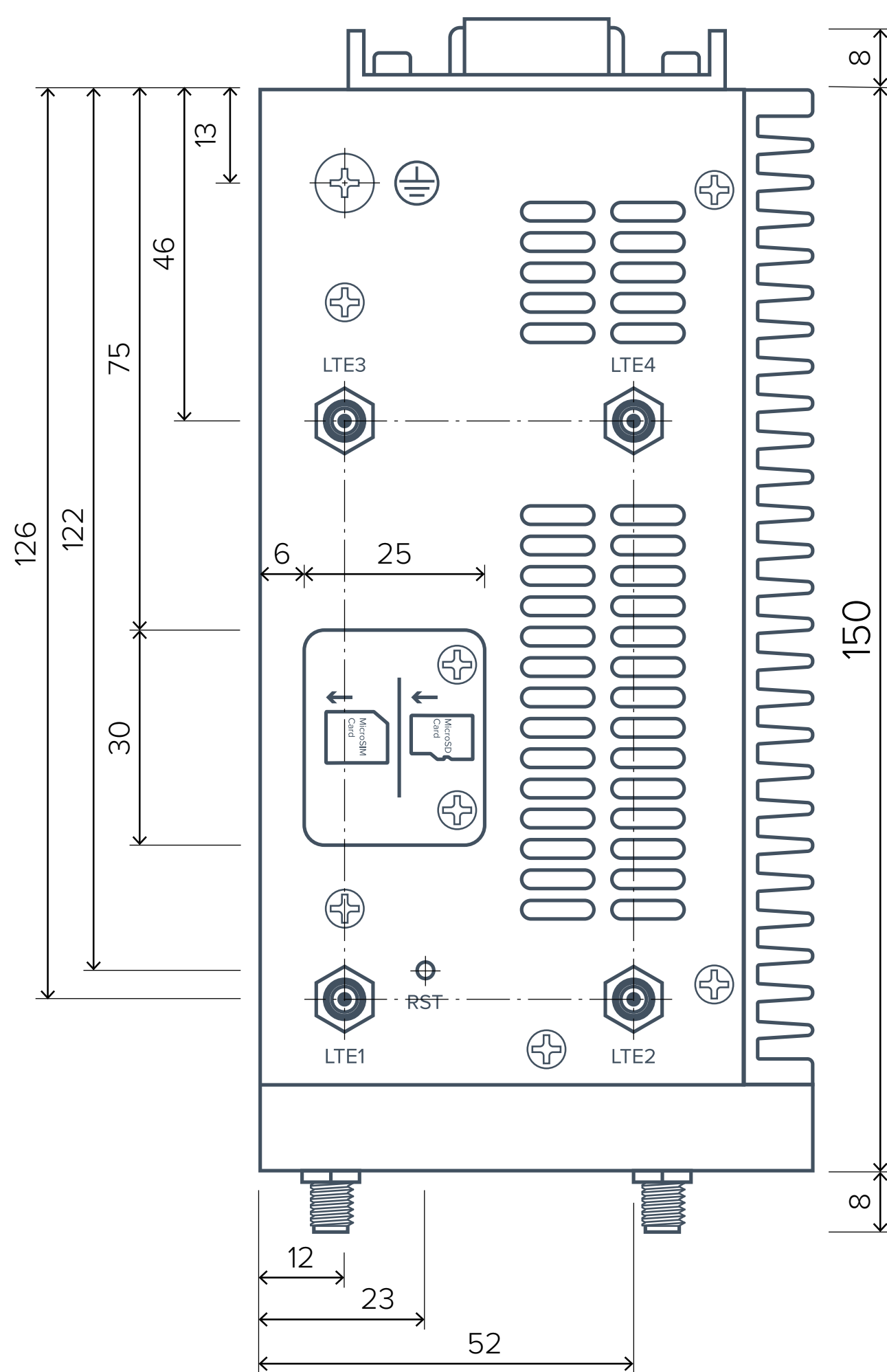
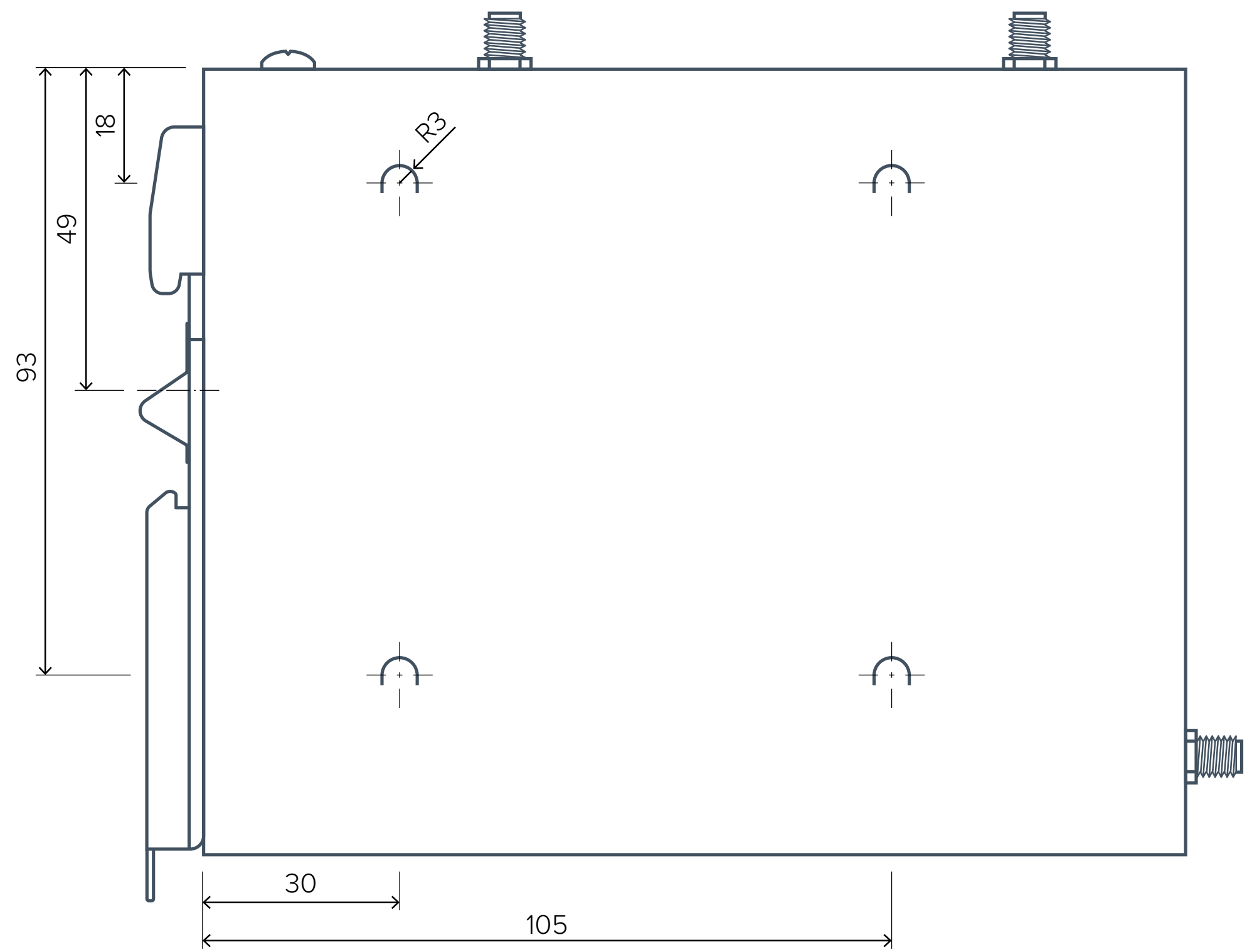
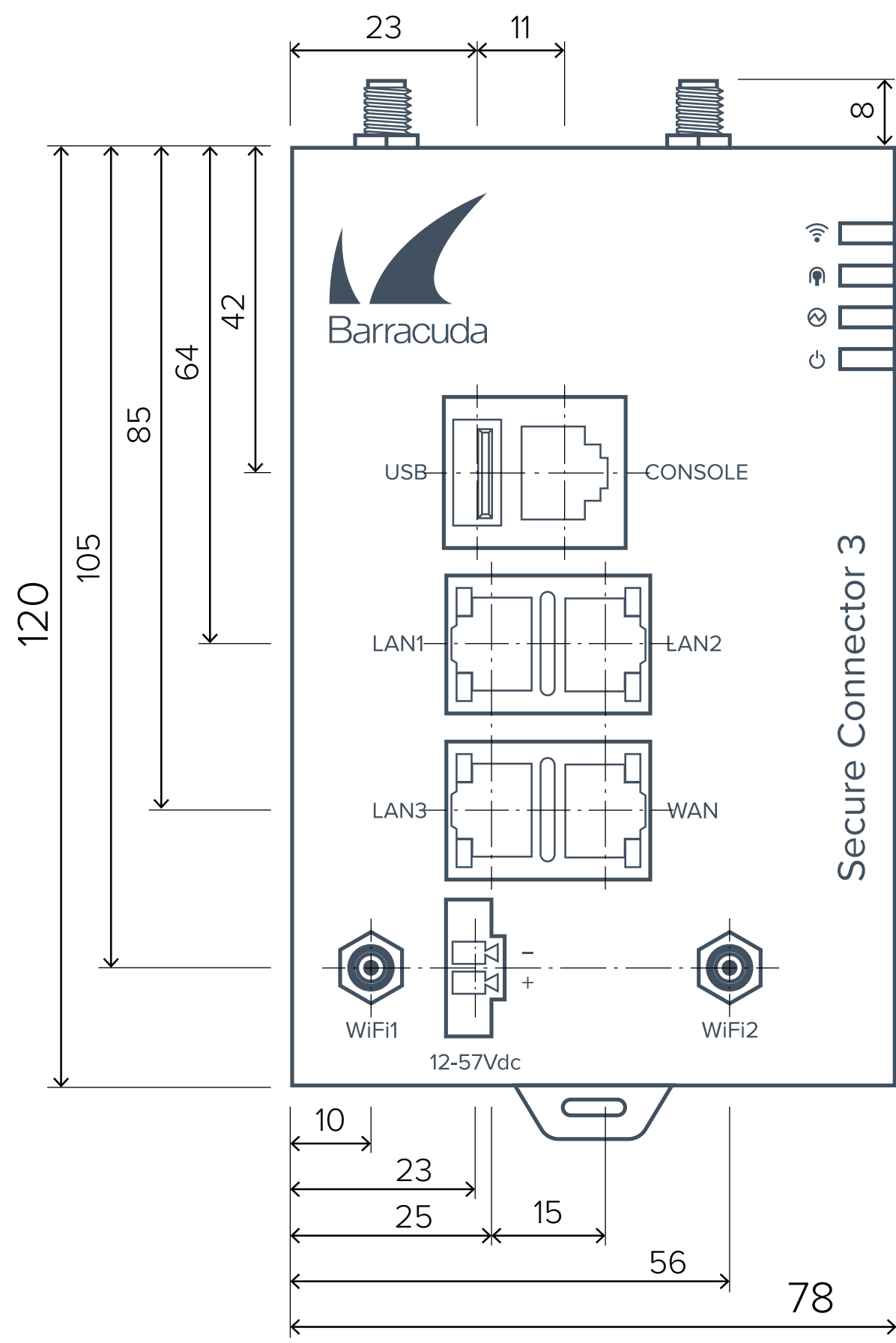

No scale illustration.  
All dimensions in mm.

# Virtual appliances

As organizations have adopted virtualization for their server infrastructures, there has been a corresponding trend to extend the benefits of virtualization to the security layer. The CloudGen Firewall Vx provides the same powerful technology, comprehensive features, and ease-of-use found in a CloudGen Firewall hardware appliance. It is ideally suited for organizations that are standardizing hardware platforms or deploying virtual environments.

Beyond its powerful network firewall, IPS, SD-WAN, and remote access technologies, CloudGen Firewall Vx integrates a comprehensive set of next-generation firewall technologies, including application control, availability, and traffic flow optimization across the wide area network, web filtering, antivirus, anti-spam, and network access control enforcement.

For more details on Barracuda virtual appliances, please visit [barracuda.com/solutions/virtual](https://barracuda.com/solutions/virtual).

All virtual editions are available for:



VX EDITIONS	VF10	VF25	VF50	VF100	VF250	VF500	VF1000	VF2000	VF4000	VF8000
<b>CAPACITY</b>										
Number of protected IPs	10	25	50	100	250	500	Unlimited	Unlimited	Unlimited	Unlimited
Allowed cores	1	2	2	2	2	2	2	4	8	16
<b>AVAILABLE SUBSCRIPTIONS</b>										
<a href="#">Barracuda Firewall Insights</a>	Optional	Optional	Optional	Optional	Optional	Optional	Optional	Optional	Optional	Optional
<a href="#">Malware Protection</a>	-	Optional	Optional	Optional	Optional	Optional	Optional	Optional	Optional	Optional
<a href="#">Advanced Threat Protection</a>	-	Optional	Optional	Optional	Optional	Optional	Optional	Optional	Optional	Optional
<a href="#">Advanced Remote Access</a>	-	Optional	Optional	Optional	Optional	Optional	Optional	Optional	Optional	Optional
<a href="#">Advanced Threat and Malware Protection Bundle</a>	-	Optional	Optional	Optional	Optional	Optional	Optional	Optional	Optional	Optional



# Features and capabilities

BARRACUDA CLOUDGEN FIREWALL FIREWALL	F12	F18	F80	F180	F280	F380	F400	F600	F800	F900	F1000	VIRTUAL
Stateful packet forwarding (per rule)	✓	✓	✓	✓	✓	✓	✓	✓	✓	✓	✓	✓
Transparent proxy (TCP; per rule)	✓	✓	✓	✓	✓	✓	✓	✓	✓	✓	✓	✓
Inline graphical packet analyser	✓	✓	✓	✓	✓	✓	✓	✓	✓	✓	✓	✓
NAT (src, dst, nets), PAT	✓	✓	✓	✓	✓	✓	✓	✓	✓	✓	✓	✓
Policy-based NAT (per rule)	✓	✓	✓	✓	✓	✓	✓	✓	✓	✓	✓	✓
Protocol support (IPv4, IPv6 <sup>3</sup> )	✓	✓	✓	✓	✓	✓	✓	✓	✓	✓	✓	✓
IP-less configuration via named networks (IPv4, IPv6)	✓	✓	✓	✓	✓	✓	✓	✓	✓	✓	✓	✓
Wildcard network objects	✓	✓	✓	✓	✓	✓	✓	✓	✓	✓	✓	✓
Gigabit performance	✓	✓	✓	✓	✓	✓	✓	✓	✓	✓	✓	✓
Object oriented rule set	✓	✓	✓	✓	✓	✓	✓	✓	✓	✓	✓	✓
Virtual rule sets	✓	✓	✓	✓	✓	✓	✓	✓	✓	✓	✓	✓
Virtual rule test environment	✓	✓	✓	✓	✓	✓	✓	✓	✓	✓	✓	✓
Realtime connection status	✓	✓	✓	✓	✓	✓	✓	✓	✓	✓	✓	✓
Historical access caches	✓	✓	✓	✓	✓	✓	✓	✓	✓	✓	✓	✓
Event triggered notification	✓	✓	✓	✓	✓	✓	✓	✓	✓	✓	✓	✓
Load balancing for protected servers	✓	✓	✓	✓	✓	✓	✓	✓	✓	✓	✓	✓
Multipath load balancing	✓	✓	✓	✓	✓	✓	✓	✓	✓	✓	✓	✓
Firewall-to-firewall compression (stream & packet compression)	✓	✓	✓	✓	✓	✓	✓	✓	✓	✓	✓	✓
Dynamic rules with timer triggered deactivation (per rule)	✓	✓	✓	✓	✓	✓	✓	✓	✓	✓	✓	✓
Bridging mode / routing mode (mixed)	✓	✓	✓	✓	✓	✓	✓	✓	✓	✓	✓	✓
Virtual IP (proxyARP) support	✓	✓	✓	✓	✓	✓	✓	✓	✓	✓	✓	✓
Transparent IP to user mapping	✓	✓	✓	✓	✓	✓	✓	✓	✓	✓	✓	✓
User authentication	x.509, Microsoft® NTLM, RADIUS, RSA SecurID, LDAP/LDAPS, Microsoft® Active Directory®, TACACS+, local											
RPC protocol support (ONC-RPC, DCE-RPC)	✓	✓	✓	✓	✓	✓	✓	✓	✓	✓	✓	✓
VoIP support (H.323, SIP, SCCP (skinny))	✓	✓	✓	✓	✓	✓	✓	✓	✓	✓	✓	✓
Deep inspection of ICS / SCADA protocols	✓	✓	✓	✓	✓	✓	✓	✓	✓	✓	✓	✓
DHCP relaying with packet loop protection & configurable agent-ID policy	✓	✓	✓	✓	✓	✓	✓	✓	✓	✓	✓	✓
Standby mode	Active-Active (with external load balancer only) and Active-Passive											
Network notification on failover	✓	✓	✓	✓	✓	✓	✓	✓	✓	✓	✓	✓
Key-based authentication	✓	✓	✓	✓	✓	✓	✓	✓	✓	✓	✓	✓
Encrypted HA communication	✓	✓	✓	✓	✓	✓	✓	✓	✓	✓	✓	✓
Provider/link failover	✓	✓	✓	✓	✓	✓	✓	✓	✓	✓	✓	✓
Transparent failover without session loss	✓	✓	✓	✓	✓	✓	✓	✓	✓	✓	✓	✓

3 IPv6 firewall forwarding traffic, IPS, and application control - only in conjunction with administration via Barracuda Firewall Admin.

BARRACUDA CLOUDGEN FIREWALL	F12	F18	F80	F180	F280	F380	F400	F600	F800	F900	F1000	VIRTUAL
<b>APPLICATION CONTROL</b>												
Deep packet inspection	✓	✓	✓	✓	✓	✓	✓	✓	✓	✓	✓	✓
Application behavior analysis	✓	✓	✓	✓	✓	✓	✓	✓	✓	✓	✓	✓
Thousands of applications and protocols supported (Skype, BitTorrent, etc.)	✓	✓	✓	✓	✓	✓	✓	✓	✓	✓	✓	✓
Social media application support (Facebook, Google+, etc.)	✓	✓	✓	✓	✓	✓	✓	✓	✓	✓	✓	✓
Media streaming application support (YouTube, Netflix, etc.)	✓	✓	✓	✓	✓	✓	✓	✓	✓	✓	✓	✓
Proxy and anonymizer detection (Hide Me, Cyberghost, etc.)	✓	✓	✓	✓	✓	✓	✓	✓	✓	✓	✓	✓
Application objects based on category, risk, properties, and popularity	✓	✓	✓	✓	✓	✓	✓	✓	✓	✓	✓	✓
Predefined categories such as business, conferencing, instant messaging, media streaming, etc.	✓	✓	✓	✓	✓	✓	✓	✓	✓	✓	✓	✓
Interception of SSL/TLS encrypted traffic	✓	✓	✓	✓	✓	✓	✓	✓	✓	✓	✓	✓
Inspection of SSL/TLS encrypted traffic	✓	✓	✓	✓	✓	✓	✓	✓	✓	✓	✓	✓
Filtering of SSL/TLS encrypted traffic	✓	✓	✓	✓	✓	✓	✓	✓	✓	✓	✓	✓
Creation of customized applications	✓	✓	✓	✓	✓	✓	✓	✓	✓	✓	✓	✓
Deep application context	✓	✓	✓	✓	✓	✓	✓	✓	✓	✓	✓	✓
Google SafeSearch enforcement	✓	✓	✓	✓	✓	✓	✓	✓	✓	✓	✓	✓
Google Accounts enforcement	✓	✓	✓	✓	✓	✓	✓	✓	✓	✓	✓	✓
Application Based Provider Selection	✓	✓	✓	✓	✓	✓	✓	✓	✓	✓	✓	✓
Bandwidth and QoS assignment	✓	✓	✓	✓	✓	✓	✓	✓	✓	✓	✓	✓
Application logging	✓	✓	✓	✓	✓	✓	✓	✓	✓	✓	✓	✓
Application blocking	✓	✓	✓	✓	✓	✓	✓	✓	✓	✓	✓	✓
Application monitor and drill-down function	✓	✓	✓	✓	✓	✓	✓	✓	✓	✓	✓	✓
Reporting	✓	✓	✓	✓	✓	✓	✓	✓	✓	✓	✓	✓



BARRACUDA CLOUDGEN FIREWALL	F12	F18	F80	F180	F280	F380	F400	F600	F800	F900	F1000	VIRTUAL
<b>INTRUSION PREVENTION SYSTEM</b>												
Inline intrusion prevention	✓	✓	✓	✓	✓	✓	✓	✓	✓	✓	✓	✓
Regular online pattern updates	✓	✓	✓	✓	✓	✓	✓	✓	✓	✓	✓	✓
Packet anomaly protection	✓	✓	✓	✓	✓	✓	✓	✓	✓	✓	✓	✓
Packet reassembly	✓	✓	✓	✓	✓	✓	✓	✓	✓	✓	✓	✓
TCP stream reassembly	✓	✓	✓	✓	✓	✓	✓	✓	✓	✓	✓	✓
TCP checksum check	✓	✓	✓	✓	✓	✓	✓	✓	✓	✓	✓	✓
TCP split handshake protection	✓	✓	✓	✓	✓	✓	✓	✓	✓	✓	✓	✓
TCP stream segmentation check	✓	✓	✓	✓	✓	✓	✓	✓	✓	✓	✓	✓
Generic patten filter	✓	✓	✓	✓	✓	✓	✓	✓	✓	✓	✓	✓
Active ARP handling	✓	✓	✓	✓	✓	✓	✓	✓	✓	✓	✓	✓
Malformed packet check	✓	✓	✓	✓	✓	✓	✓	✓	✓	✓	✓	✓
SMB & NetBIOS evasion protection	✓	✓	✓	✓	✓	✓	✓	✓	✓	✓	✓	✓
HTML decoding	✓	✓	✓	✓	✓	✓	✓	✓	✓	✓	✓	✓
HTML decompression	✓	✓	✓	✓	✓	✓	✓	✓	✓	✓	✓	✓
HTML obfuscation protection	✓	✓	✓	✓	✓	✓	✓	✓	✓	✓	✓	✓
<b>URL OBFUSCATION PROTECTION</b>												
Escape encoding support	✓	✓	✓	✓	✓	✓	✓	✓	✓	✓	✓	✓
Microsoft %u encoding support	✓	✓	✓	✓	✓	✓	✓	✓	✓	✓	✓	✓
Path character transformations and expansions supported	✓	✓	✓	✓	✓	✓	✓	✓	✓	✓	✓	✓
<b>RPC FRAGMENTATION PROTECTION</b>												
MS-RPC (DCE) defragmentation supported (RFC 1151)	✓	✓	✓	✓	✓	✓	✓	✓	✓	✓	✓	✓
SUN-RPC (ONC) defragmentation supported (RFC 1151)	✓	✓	✓	✓	✓	✓	✓	✓	✓	✓	✓	✓
<b>FTP EVASION PROTECTION</b>												
Detection of inserted spaces in FTP command lines	✓	✓	✓	✓	✓	✓	✓	✓	✓	✓	✓	✓
Detection of additional telnet control sequences in FTP commands	✓	✓	✓	✓	✓	✓	✓	✓	✓	✓	✓	✓
<b>DENIAL OF SERVICE, SPOOFING &amp; FLOODING PROTECTION</b>												
IP spoofing protection	✓	✓	✓	✓	✓	✓	✓	✓	✓	✓	✓	✓
Port scan protection	✓	✓	✓	✓	✓	✓	✓	✓	✓	✓	✓	✓
Sniffing protection	✓	✓	✓	✓	✓	✓	✓	✓	✓	✓	✓	✓
SYN/DoS/DDoS attack protection	✓	✓	✓	✓	✓	✓	✓	✓	✓	✓	✓	✓
LAND attack protection	✓	✓	✓	✓	✓	✓	✓	✓	✓	✓	✓	✓
Teardrop / IP fragment attack protection	✓	✓	✓	✓	✓	✓	✓	✓	✓	✓	✓	✓
UDP flood protection	✓	✓	✓	✓	✓	✓	✓	✓	✓	✓	✓	✓
ICMP fragment protection	✓	✓	✓	✓	✓	✓	✓	✓	✓	✓	✓	✓
ICMP flood ping protection	✓	✓	✓	✓	✓	✓	✓	✓	✓	✓	✓	✓
Reverse routing path check	✓	✓	✓	✓	✓	✓	✓	✓	✓	✓	✓	✓
IPS exceptions (allow listing)	✓	✓	✓	✓	✓	✓	✓	✓	✓	✓	✓	✓
<b>IPS EXCEPTIONS BASED ON</b>												
Source / destination	✓	✓	✓	✓	✓	✓	✓	✓	✓	✓	✓	✓
Port & port range	✓	✓	✓	✓	✓	✓	✓	✓	✓	✓	✓	✓
Signature / CVE	✓	✓	✓	✓	✓	✓	✓	✓	✓	✓	✓	✓

BARRACUDA CLOUDGEN FIREWALL MALWARE PROTECTION	F12	F18	F80	F180	F280	F380	F400	F600	F800	F900	F1000	VIRTUAL
Single-pass mode	✓	✓	✓	✓	✓	✓	✓	✓	✓	✓	✓	✓ <sup>[5]</sup>
Proxy mode	✓	✓	✓	✓	✓	✓	✓	✓	✓	✓	✓	✓ <sup>[5]</sup>
Configurable archive recursion depth	✓ <sup>[4]</sup>	✓	✓	✓	✓	✓	✓	✓	✓	✓	✓	✓ <sup>[5]</sup>
Quarantine functionality for proxy	✓ <sup>[4]</sup>	✓	✓	✓	✓	✓	✓	✓	✓	✓	✓	✓ <sup>[5]</sup>
Configurable unknown archive policy	✓ <sup>[4]</sup>	✓	✓	✓	✓	✓	✓	✓	✓	✓	✓	✓ <sup>[5]</sup>
Configurable maximum archive size	✓ <sup>[4]</sup>	✓	✓	✓	✓	✓	✓	✓	✓	✓	✓	✓ <sup>[5]</sup>
Archiver package support	✓ <sup>[4]</sup>	✓	✓	✓	✓	✓	✓	✓	✓	✓	✓	✓ <sup>[5]</sup>
Office file-types support	✓ <sup>[4]</sup>	✓	✓	✓	✓	✓	✓	✓	✓	✓	✓	✓ <sup>[5]</sup>
Proactive detection of new threats	✓ <sup>[4]</sup>	✓	✓	✓	✓	✓	✓	✓	✓	✓	✓	✓ <sup>[5]</sup>
Advanced heuristics detection techniques	✓ <sup>[4]</sup>	✓	✓	✓	✓	✓	✓	✓	✓	✓	✓	✓ <sup>[5]</sup>
Number of signatures	Billions <sup>[4]</sup>	Hundreds of thousands <sup>[5]</sup>										
Frequency of signature updates	Online <sup>[4]</sup>	Multiple updates per day <sup>[5]</sup>										
Dynamic, on-demand analysis of malware programs (sandbox)	✓	✓	✓	✓	✓	✓	✓	✓	✓	✓	✓	✓ <sup>[5]</sup>

BARRACUDA CLOUDGEN FIREWALL ADVANCED THREAT PROTECTION	F12	F18	F80	F180	F280	F380	F400	F600	F800	F900	F1000	VIRTUAL
Dynamic analysis of documents with embedded exploits (PDF, Office, etc.)	✓	✓	✓	✓	✓	✓	✓	✓	✓	✓	✓	✓ <sup>[5]</sup>
Detailed forensics for both, malware binaries, and web threats (exploits)	✓	✓	✓	✓	✓	✓	✓	✓	✓	✓	✓	✓ <sup>[5]</sup>
High resolution malware analysis (monitoring, execution from the inside)	✓	✓	✓	✓	✓	✓	✓	✓	✓	✓	✓	✓ <sup>[5]</sup>
TypoSquatting and link protection for emails	✓	✓	✓	✓	✓	✓	✓	✓	✓	✓	✓	✓ <sup>[5]</sup>
Support for multiple operating systems (Windows, Android, etc.)	✓	✓	✓	✓	✓	✓	✓	✓	✓	✓	✓	✓ <sup>[5]</sup>
Flexible malware analysis in the cloud	✓	✓	✓	✓	✓	✓	✓	✓	✓	✓	✓	✓ <sup>[5]</sup>
<b>SUPPORTED FILE TYPES</b>												
Microsoft executables (exe, msi, dll, class, wsf)	✓	✓	✓	✓	✓	✓	✓	✓	✓	✓	✓	✓ <sup>[5]</sup>
Adobe PDF documents	✓	✓	✓	✓	✓	✓	✓	✓	✓	✓	✓	✓ <sup>[5]</sup>
Android APK files	✓	✓	✓	✓	✓	✓	✓	✓	✓	✓	✓	✓ <sup>[5]</sup>
ZIP archives	✓	✓	✓	✓	✓	✓	✓	✓	✓	✓	✓	✓ <sup>[5]</sup>
RAR archives	✓	✓	✓	✓	✓	✓	✓	✓	✓	✓	✓	✓ <sup>[5]</sup>
macOS executables (dmg)	✓	✓	✓	✓	✓	✓	✓	✓	✓	✓	✓	✓ <sup>[5]</sup>
Microsoft Office (doc, docx, xls, xlsx, ...)	✓	✓	✓	✓	✓	✓	✓	✓	✓	✓	✓	✓ <sup>[5]</sup>
Microsoft Office macro enabled (doc, docx, xls, xlsx, ...)	✓	✓	✓	✓	✓	✓	✓	✓	✓	✓	✓	✓ <sup>[5]</sup>
OpenOffice (odt, ods, rtf, ...)	✓	✓	✓	✓	✓	✓	✓	✓	✓	✓	✓	✓ <sup>[5]</sup>
Javascript (manual scan)	✓	✓	✓	✓	✓	✓	✓	✓	✓	✓	✓	✓ <sup>[5]</sup>
Other archives (7z, lzh, bz, bz2, chm, cab, tar, gzip, gz)	✓	✓	✓	✓	✓	✓	✓	✓	✓	✓	✓	✓ <sup>[5]</sup>
<b>SUPPORTED PROTOCOLS</b>												
HTTP	✓	✓	✓	✓	✓	✓	✓	✓	✓	✓	✓	✓ <sup>[5]</sup>
HTTPS	✓	✓	✓	✓	✓	✓	✓	✓	✓	✓	✓	✓ <sup>[5]</sup>
FTP	✓	✓	✓	✓	✓	✓	✓	✓	✓	✓	✓	✓ <sup>[5]</sup>
FTPS	✓	✓	✓	✓	✓	✓	✓	✓	✓	✓	✓	✓ <sup>[5]</sup>
SMTP	✓	✓	✓	✓	✓	✓	✓	✓	✓	✓	✓	✓ <sup>[5]</sup>
SMTPS	✓	✓	✓	✓	✓	✓	✓	✓	✓	✓	✓	✓ <sup>[5]</sup>

4 Model F12A doesn't provide on-board malware protection but online malware protection as part of an active Advanced Threat Protection subscription. Hash calculation takes place on-board and the hash is then sent to BATP for verification.  
 5 Does not apply for virtual model VF10.



BARRACUDA CLOUDGEN FIREWALL WEB FILTER	F12	F18	F80	F180	F280	F380	F400	F600	F800	F900	F1000	VIRTUAL
Block/allow lists (per rule)	✓	✓	✓	✓	✓	✓	✓	✓	✓	✓	✓	✓ <sup>[6]</sup>
Filter categories	95 <sup>[6]</sup>											
Number of URLs categorized	>100 million <sup>[6]</sup>											
Alexa top 1 million coverage	> 90% <sup>[6]</sup>											
Temporal constraints	✓	✓	✓	✓	✓	✓	✓	✓	✓	✓	✓	✓ <sup>[6]</sup>
User specific / group specific restrictions	✓	✓	✓	✓	✓	✓	✓	✓	✓	✓	✓	✓ <sup>[6]</sup>
Cached online category database	✓	✓	✓	✓	✓	✓	✓	✓	✓	✓	✓	✓ <sup>[6]</sup>
Local update interval	N/A											
Online update interval	continuously <sup>[6]</sup>											

BARRACUDA CLOUDGEN FIREWALL TRAFFIC INTELLIGENCE & SD-WAN	F12	F18	F80	F180	F280	F380	F400	F600	F800	F900	F1000	VIRTUAL
SD-WAN (incl. Traffic shaping inside encrypted tunnels)	✓	✓	✓	✓	✓	✓	✓	✓	✓	✓	✓	✓
Optimized direct internet uplink selection	✓	✓	✓	✓	✓	✓	✓	✓	✓	✓	✓	✓
Distribution of site-to-site encrypted traffic across up to 24 uplinks	✓	✓	✓	✓	✓	✓	✓	✓	✓	✓	✓	✓
Quality of service (QoS)	✓	✓	✓	✓	✓	✓	✓	✓	✓	✓	✓	✓
Automatic backup uplink activation	✓	✓	✓	✓	✓	✓	✓	✓	✓	✓	✓	✓
Automatic activation of alternate QoS policy upon main WAN failure and backup uplink activation	✓	✓	✓	✓	✓	✓	✓	✓	✓	✓	✓	✓
Dynamic bandwidth and latency detection between peers	✓	✓	✓	✓	✓	✓	✓	✓	✓	✓	✓	✓
Performance-based transport selection	✓	✓	✓	✓	✓	✓	✓	✓	✓	✓	✓	✓
Adaptive bandwidth protection	✓	✓	✓	✓	✓	✓	✓	✓	✓	✓	✓	✓
Adaptive session balancing	✓	✓	✓	✓	✓	✓	✓	✓	✓	✓	✓	✓
Traffic replication	✓	✓	✓	✓	✓	✓	✓	✓	✓	✓	✓	✓
Firewall / encrypted traffic compression	✓	✓	✓	✓	✓	✓	✓	✓	✓	✓	✓	✓
Zero-touch deployment	✓	✓	✓	✓	✓	✓	✓	✓	✓	✓	✓	-
Data deduplication	✓	✓	✓	✓	✓	✓	✓	✓	✓	✓	✓	✓
Link aggregation	✓	✓	✓	✓	✓	✓	✓	✓	✓	✓	✓	✓
Maximum overall bandwidth per interface	✓	✓	✓	✓	✓	✓	✓	✓	✓	✓	✓	✓
On-the-fly reprioritization via firewall status GUI	✓	✓	✓	✓	✓	✓	✓	✓	✓	✓	✓	✓
Ingress shaping per interface	✓	✓	✓	✓	✓	✓	✓	✓	✓	✓	✓	✓
Application-specific bandwidth assignment	✓	✓	✓	✓	✓	✓	✓	✓	✓	✓	✓	✓
Application-based provider selection	✓	✓	✓	✓	✓	✓	✓	✓	✓	✓	✓	✓
URL-filter-category specific provider selection	✓	✓	✓	✓	✓	✓	✓	✓	✓	✓	✓	✓
Dynamic forward error correction (FEC) for packet loss mitigation	✓	✓	✓	✓	✓	✓	✓	✓	✓	✓	✓	✓

6 Does not apply for virtual model VF10.

BARRACUDA CLOUDGEN FIREWALL ROUTING & NETWORKING	F12	F18	F80	F180	F280	F380	F400	F600	F800	F900	F1000	VIRTUAL
HA capable with transparent session failover	✓	✓	✓	✓	✓	✓	✓	✓	✓	✓	✓	✓
GbE ethernet support	✓	✓	✓	✓	✓	✓	✓	✓	✓	✓	✓	✓
Max. number of physical interfaces	5	5	5	16	16	10	14	20	24	32	40	n/a
Integrated DSL modem	-	-	-	-	-	-	-	-	-	-	-	n/a
802.1q VLAN support	✓	✓	✓	✓	✓	✓	✓	✓	✓	✓	✓	✓
xDSL support (PPPoE, PPTP (multi-link))	✓	✓	✓	✓	✓	✓	✓	✓	✓	✓	✓	✓
DHCP client support	✓	✓	✓	✓	✓	✓	✓	✓	✓	✓	✓	✓
ISDN support (EuroISDN (syncppp, rawip))	✓	✓	✓	✓	✓	-	-	-	-	-	-	-
Link monitoring (DHCP, xDSL, ISDN)	✓	✓	✓	✓	✓	✓	✓	✓	✓	✓	✓	✓
Policy routing support	✓	✓	✓	✓	✓	✓	✓	✓	✓	✓	✓	✓
Ethernet channel bonding	✓	✓	✓	✓	✓	✓	✓	✓	✓	✓	✓	✓
Multiple networks on interface, IP aliases	✓	✓	✓	✓	✓	✓	✓	✓	✓	✓	✓	✓
Multiple provider / WAN link support	✓	✓	✓	✓	✓	✓	✓	✓	✓	✓	✓	✓
Configurable MTU size (per route)	✓	✓	✓	✓	✓	✓	✓	✓	✓	✓	✓	✓
Jumbo frames (up to 9,000 bytes)	✓	✓	✓	✓	✓	✓	✓	✓	✓	✓	✓	✓
IPinIP and GRE tunnels	✓	✓	✓	✓	✓	✓	✓	✓	✓	✓	✓	✓
PPTP	✓	✓	✓	✓	✓	✓	✓	✓	✓	✓	✓	✓
BGP	✓	✓	✓	✓	✓	✓	✓	✓	✓	✓	✓	✓
Virtual routing and forwarding (VRF) instances	10	10	10	10	10	10	10	10	15	20	25	✓ <sup>[7]</sup>
Dynamic routing of encrypted traffic	✓	✓	✓	✓	✓	✓	✓	✓	✓	✓	✓	✓
Dynamic routing (BGP, OSPF, RIP)	✓	✓	✓	✓	✓	✓	✓	✓	✓	✓	✓	✓

BARRACUDA CLOUDGEN FIREWALL REMOTE ACCESS	F12	F18	F80	F180	F280	F380	F400	F600	F800	F900	F1000	VIRTUAL
Encryption support	AES-128/256, 3DES/ DES, CAST, Blowfish, Null											
Private CA (up to 4,096 bit RSA)	✓	✓	✓	✓	✓	✓	✓	✓	✓	✓	✓	✓
External PKI support	✓	✓	✓	✓	✓	✓	✓	✓	✓	✓	✓	✓
x.509v3 policy extensions (fully recognized)	✓	✓	✓	✓	✓	✓	✓	✓	✓	✓	✓	✓
Certificate revocation (OCSP, CRL)	✓	✓	✓	✓	✓	✓	✓	✓	✓	✓	✓	✓
Site-to-site encrypted SD-WAN with traffic intelligence	✓	✓	✓	✓	✓	✓	✓	✓	✓	✓	✓	✓
Dynamic mesh remote encrypted connectivity	✓	✓	✓	✓	✓	✓	✓	✓	✓	✓	✓	✓
Traffic compression	✓	✓	✓	✓	✓	✓	✓	✓	✓	✓	✓	✓
Star (hub and spoke) remote access network topology	✓	✓	✓	✓	✓	✓	✓	✓	✓	✓	✓	✓
Client remote access	✓	✓	✓	✓	✓	✓	✓	✓	✓	✓	✓	✓
Microsoft® domain logon (Pre-logon)	✓	✓	✓	✓	✓	✓	✓	✓	✓	✓	✓	✓
Strong user authentication	✓	✓	✓	✓	✓	✓	✓	✓	✓	✓	✓	✓
Replay protection	✓	✓	✓	✓	✓	✓	✓	✓	✓	✓	✓	✓
NAT traversal	✓	✓	✓	✓	✓	✓	✓	✓	✓	✓	✓	✓
HTTPS and SOCKS proxy compatible	✓	✓	✓	✓	✓	✓	✓	✓	✓	✓	✓	✓
Redundant gateways	✓	✓	✓	✓	✓	✓	✓	✓	✓	✓	✓	✓
Native IPsec for third-party connectivity	✓	✓	✓	✓	✓	✓	✓	✓	✓	✓	✓	✓
PPTP/L2TP (IPsec; remote access client only)	✓	✓	✓	✓	✓	✓	✓	✓	✓	✓	✓	✓
Dynamic routing (OSPF, BGP) over encrypted remote access	✓	✓	✓	✓	✓	✓	✓	✓	✓	✓	✓	✓

<sup>7</sup> For detailed information regarding VRF instances on virtual deployments, please check [Barracuda Campus](#).



BARRACUDA CLOUDGEN FIREWALL SYSTEM MANAGEMENT	F12	F18	F80	F180	F280	F380	F400	F600	F800	F900	F1000	VIRTUAL
Central management	✓	✓	✓	✓	✓	✓	✓	✓	✓	✓	✓	✓
Local management	✓	✓	✓	✓	✓	✓	✓	✓	✓	✓	✓	✓
Comprehensive GUI-based configuration management	✓	✓	✓	✓	✓	✓	✓	✓	✓	✓	✓	✓
WebUI-based configuration management	-	✓	✓	✓	✓	✓	✓	-	-	-	-	- <sup>[8]</sup>
Command-line interface (CLI) available	✓	✓	✓	✓	✓	✓	✓	✓	✓	✓	✓	✓
SSH-based access	✓	✓	✓	✓	✓	✓	✓	✓	✓	✓	✓	✓
Multiple administrators	✓	✓	✓	✓	✓	✓	✓	✓	✓	✓	✓	✓
Role-based administrators	✓	✓	✓	✓	✓	✓	✓	✓	✓	✓	✓	✓
Real-time accounting and visualization	✓	✓	✓	✓	✓	✓	✓	✓	✓	✓	✓	✓
Easy roll-out and recovery	✓	✓	✓	✓	✓	✓	✓	✓	✓	✓	✓	✓
USB installation and recovery	✓	✓	✓	✓	✓	✓	✓	✓	✓	✓	✓	✓
Zero-touch deployment	✓	✓	✓	✓	✓	✓	✓	✓	✓	✓	✓	-
Full life-cycle management	✓	✓	✓	✓	✓	✓	✓	✓	✓	✓	✓	✓
In-band management	✓	✓	✓	✓	✓	✓	✓	✓	✓	✓	✓	✓
Dedicated management interface	✓	✓	✓	✓	✓	✓	✓	✓	✓	✓	✓	✓
Serial interfaces	✓	✓	✓	✓	✓	✓	✓	✓	✓	✓	✓	✓
Central management interface	✓	✓	✓	✓	✓	✓	✓	✓	✓	✓	✓	✓
All management via encrypted remote access connections	✓	✓	✓	✓	✓	✓	✓	✓	✓	✓	✓	✓

BARRACUDA CLOUDGEN FIREWALL LOGGING/MONITORING/ACCOUNTING	F12	F18	F80	F180	F280	F380	F400	F600	F800	F900	F1000	VIRTUAL
System health, activity monitoring	✓	✓	✓	✓	✓	✓	✓	✓	✓	✓	✓	✓
Human readable log files	✓	✓	✓	✓	✓	✓	✓	✓	✓	✓	✓	✓
Statistics	-	-	-	✓	✓	✓	✓	✓	✓	✓	✓	✓
Active event notification	Email / Execute program / SNMP trap / Apple push notification service / Slack notification											
Real-time accounting and reporting	✓	✓	✓	✓	✓	✓	✓	✓	✓	✓	✓	✓
Syslog streaming (fully GUI configurable)	✓	✓	✓	✓	✓	✓	✓	✓	✓	✓	✓	✓

BARRACUDA CLOUDGEN FIREWALL ADDITIONAL FUNCTIONS	F12	F18	F80	F180	F280	F380	F400	F600	F800	F900	F1000	VIRTUAL
SNMP queries	✓	✓	✓	✓	✓	✓	✓	✓	✓	✓	✓	✓
SMS control	✓	✓	✓	✓	✓	✓	✓	✓	✓	✓	✓	✓
NTP4 time server and clients	✓	✓	✓	✓	✓	✓	✓	✓	✓	✓	✓	✓

BARRACUDA CLOUDGEN FIREWALL DNS	F12	F18	F80	F180	F280	F380	F400	F600	F800	F900	F1000	VIRTUAL
Multi-domain support	✓	✓	✓	✓	✓	✓	✓	✓	✓	✓	✓	✓
DNS operation types	Primary, secondary, forwarder, cacher											
Split DNS	✓	✓	✓	✓	✓	✓	✓	✓	✓	✓	✓	✓
Health probing	✓	✓	✓	✓	✓	✓	✓	✓	✓	✓	✓	✓
DNS doctoring	✓	✓	✓	✓	✓	✓	✓	✓	✓	✓	✓	✓
DNS translation	✓	✓	✓	✓	✓	✓	✓	✓	✓	✓	✓	✓
DNS interception	✓	✓	✓	✓	✓	✓	✓	✓	✓	✓	✓	✓
Detect and block DNS tunneling	✓	✓	✓	✓	✓	✓	✓	✓	✓	✓	✓	✓

8 WebUI-based configuration management is available for deployments in Amazon Web Services (BYOL and PAYG), Microsoft Azure (BYOL and PAYG), and Google Cloud Platform (BYOL)

BARRACUDA CLOUDGEN FIREWALL AUTHORITATIVE DNS SERVER	F12	F18	F80	F180	F280	F380	F400	F600	F800	F900	F1000	VIRTUAL
Local DNS cache	✓	✓	✓	✓	✓	✓	✓	✓	✓	✓	✓	✓
Inbound link balancing	✓	✓	✓	✓	✓	✓	✓	✓	✓	✓	✓	✓
Multi-domain support	✓	✓	✓	✓	✓	✓	✓	✓	✓	✓	✓	✓
Zone transfer (allows / prevent)	✓	✓	✓	✓	✓	✓	✓	✓	✓	✓	✓	✓
Time-to-live (TTL) enforcement	✓	✓	✓	✓	✓	✓	✓	✓	✓	✓	✓	✓
A server record support (A)	✓	✓	✓	✓	✓	✓	✓	✓	✓	✓	✓	✓
Name server record support (NS)	✓	✓	✓	✓	✓	✓	✓	✓	✓	✓	✓	✓
Mail server record support (MX)	✓	✓	✓	✓	✓	✓	✓	✓	✓	✓	✓	✓
TXT / SPF record support (TXT)	✓	✓	✓	✓	✓	✓	✓	✓	✓	✓	✓	✓
Canonical name support (CNAME)	✓	✓	✓	✓	✓	✓	✓	✓	✓	✓	✓	✓
Services available record support (SRV)	✓	✓	✓	✓	✓	✓	✓	✓	✓	✓	✓	✓
Pointer resource record support (PTR)	✓	✓	✓	✓	✓	✓	✓	✓	✓	✓	✓	✓
Customizable DNS record support (OTHER)	✓	✓	✓	✓	✓	✓	✓	✓	✓	✓	✓	✓
Health checks per IP	✓	✓	✓	✓	✓	✓	✓	✓	✓	✓	✓	✓
Configurable health check interval	✓	✓	✓	✓	✓	✓	✓	✓	✓	✓	✓	✓
Configurable update interval for dynamic IPs	✓	✓	✓	✓	✓	✓	✓	✓	✓	✓	✓	✓
Support for static uplinks	✓	✓	✓	✓	✓	✓	✓	✓	✓	✓	✓	✓
Support for dynamic uplinks	✓	✓	✓	✓	✓	✓	✓	✓	✓	✓	✓	✓

BARRACUDA CLOUDGEN FIREWALL DHCP	F12	F18	F80	F180	F280	F380	F400	F600	F800	F900	F1000	VIRTUAL
DHCP server	✓	✓	✓	✓	✓	✓	✓	✓	✓	✓	✓	✓
DHCP relay	✓	✓	✓	✓	✓	✓	✓	✓	✓	✓	✓	✓
Lease DB visualization & management	✓	✓	✓	✓	✓	✓	✓	✓	✓	✓	✓	✓
Multi-homing, multi-netting	✓	✓	✓	✓	✓	✓	✓	✓	✓	✓	✓	✓
Class-based filtering	✓	✓	✓	✓	✓	✓	✓	✓	✓	✓	✓	✓
Dynamic DNS support	✓	✓	✓	✓	✓	✓	✓	✓	✓	✓	✓	✓

BARRACUDA CLOUDGEN FIREWALL MAIL SECURITY	F12	F18	F80	F180	F280	F380	F400	F600	F800	F900	F1000	VIRTUAL
Supported protocols	SMTP, SMTP with StartTLS, SMTPS, POP3, POP3S <sup>[12]</sup>											
SSL Interception	-	✓	✓	✓	✓	✓	✓	✓	✓	✓	✓	✓ <sup>[9]</sup>
DNS block list	✓	✓	✓	✓	✓	✓	✓	✓	✓	✓	✓	✓ <sup>[9]</sup>
Antivirus for email	-	optional <sup>[9]</sup>										
Advanced Threat Protection for email	✓	optional <sup>[9]</sup>										

9 Does not apply for virtual model VF10.



BARRACUDA CLOUDGEN FIREWALL WEB PROXY	F12	F18	F80	F180	F280	F380	F400	F600	F800	F900	F1000	VIRTUAL
Supports cache hierarchies (parenting, neighboring)	✓	✓	✓	✓	✓	✓	✓	✓	✓	✓	✓	✓
Cache hierarchies supporting protocols	ICP, HTCP, CARP, Cache Digest, WCCP											
Proxying and caching (HTTP, FTP, and others)	✓	✓	✓	✓	✓	✓	✓	✓	✓	✓	✓	✓
Proxying for SSL (no inspection)	✓	✓	✓	✓	✓	✓	✓	✓	✓	✓	✓	✓
Transparent caching	✓	✓	✓	✓	✓	✓	✓	✓	✓	✓	✓	✓
HTTP server acceleration	✓	✓	✓	✓	✓	✓	✓	✓	✓	✓	✓	✓
Caching of DNS lookups	✓	✓	✓	✓	✓	✓	✓	✓	✓	✓	✓	✓
Central user authentication	Native NTLM, RADIUS, RSA ACE, LDAP, MS Active Directory, TACACS+											
Support for external virus scanning (ICAP)	✓	✓	✓	✓	✓	✓	✓	✓	✓	✓	✓	✓

BARRACUDA CLOUDGEN FIREWALL REST API EXTENSIONS	F12	F18	F80	F180	F280	F380	F400	F600	F800	F900	F1000	VIRTUAL
Please note that the following is a non-exhaustive list. For more details, please refer to <a href="https://campus.barracuda.com">campus.barracuda.com</a> .												
REST for all common access rule operations	Create / delete / list / change											
REST calls for network objects (stand-alone + CC)	✓	✓	✓	✓	✓	✓	✓	✓	✓	✓	✓	✓
REST calls for service objects (CC + stand-alone)	✓	✓	✓	✓	✓	✓	✓	✓	✓	✓	✓	✓
REST calls for enabling and activating IPS	✓	✓	✓	✓	✓	✓	✓	✓	✓	✓	✓	✓
REST calls to allow you to manage box administrators	✓	✓	✓	✓	✓	✓	✓	✓	✓	✓	✓	✓
REST calls to allow you to manage tokens	✓	✓	✓	✓	✓	✓	✓	✓	✓	✓	✓	✓
CLI tool to enable REST by default on cloud firewalls	✓	✓	✓	✓	✓	✓	✓	✓	✓	✓	✓	✓

BARRACUDA CLOUDGEN FIREWALL CLOUD-SPECIFICS	MICROSOFT AZURE	AMAZON WEB SERVICES	GOOGLE CLOUD PLATFORM
In addition to supporting features as mentioned above in column "Virtual", the public cloud editions support unique capabilities.			
Cloud-SDK support	✓	✓	✓
Auto Scaling Cluster	-	✓	-
Cold Standby Cluster	-	✓	-
Log File Streaming and Custom Metrics for AWS CloudWatch	-	✓	-
Log File Streaming to Azure OMS	✓	-	-
Azure Virtual WAN support	✓	-	-

BARRACUDA CLOUDGEN FIREWALL ZERO TRUST ACCESS	BARRACUDA CLOUDGEN ACCESS INTEGRATION
<b>CLOUDGEN ACCESS PROXY</b>	
SSO and authentication enforcement	✓
Access privilege enforcement	✓
Listen to requests	✓
Check permissions and proxies accordingly	✓

ADVANCED REMOTE ACCESS	
REMOTE & NETWORK ACCESS CLIENTS	
<b>ARCHITECTURE</b>	
Integrated remote access client	✓
Integrated health agent and managed personal firewall	✓ <sup>[13]</sup>
Full NAC policy support	✓ <sup>[13]</sup>
Customizable user interface	✓
Low power consumption network stack	✓
<b>SUPPORTED OS VARIANTS</b>	
Microsoft Windows Vista (32-bit, 64-bit)	✓
Microsoft Windows 7 (32-bit, 64-bit)	✓
Microsoft Windows 8 (32-bit, 64-bit)	✓
Microsoft Windows 10 (32-bit, 64-bit)	✓
Linux (kernel 2.4, kernel 2.6)	✓
macOS (10.5-10.15, 11)	✓
<b>MANAGEMENT</b>	
Central management of configuration	✓
Diagnostic log	✓
System diagnostics report	✓
Status monitoring	✓
Attack access cache	✓
Packet log (capture)	✓
Groups	✓
Silent client setup	✓
Password protection of settings	✓ <sup>[10], [11]</sup>
<b>AUTHENTICATION SUPPORT</b>	
Microsoft® Certificate Management (Crypto API)	✓ <sup>[10]</sup>
Microsoft® Active Directory	✓ <sup>[10]</sup>
LDAP	✓ <sup>[12]</sup>
RADIUS	✓ <sup>[12]</sup>
MSNT	✓ <sup>[10], [12]</sup>
RSAACE	✓ <sup>[12]</sup>
SAML	✓
External X509 certificates	✓
Azure AD	✓
SMS PASSCODE	✓ <sup>[12]</sup>
RSA tokens	✓ <sup>[12]</sup>
Smart cards	✓ <sup>[13]</sup>
Microsoft domain logon support (prelogon)	✓ <sup>[13]</sup>
Two-factor authentication (RSA SecurID, Radius, TOTP)	✓ <sup>[13]</sup>
<b>PERSONAL FIREWALL CAPABILITIES</b>	
Dynamic adapter object & user object handling	✓
RPC handling	✓
Multiple rule sets support	✓
Client side policy enforcement	✓
Application control	✓
Adapter control	✓
User context enforcement	✓
NetBIOS protection	✓
DoS attack protection	✓
Executable scripts	✓

10 Only for Microsoft operating systems.  
 11 Also prevents changes to client settings by users with administrator rights.  
 12 Queried by Barracuda CloudGen Firewall remote access server on behalf of client.  
 13 For manufacturer with Microsoft Crypto Service Provider.



ADVANCED REMOTE ACCESS CUDALAUNCH	CUDALAUNCH				BROWSER-BASED ACCESS
	WINDOWS	MACOS	IOS	ANDROID	
Access to web apps (reverse proxied internal apps)	✓	✓	✓	✓	✓
Access to tunnel web apps (internal apps via SSL tunnel)	✓	✓	✓	✓	-
RDP (via SSL tunnel)	✓	✓	✓	✓	-
SSL tunnels for native client apps	✓	✓	✓	✓	-
IP remote access connections (connect device to network)	TINA protocol	-	IPsec	TINA protocol	-
Built-in demo setup	✓	✓	✓	✓	✓
Central administration via CloudGen Firewall and Firewall Admin	✓	✓	✓	✓	✓
Automatic self-configuration and management of remote access connections	✓	✓	✓	✓	-
Integration with CloudGen Firewall User Authentication	✓	✓	✓	✓	✓
Access policies utilizing multi-factor and multi-policy authentication	✓	✓	✓	✓	✓
Client certificate authentication	✓	✓	✓	✓	-
Single sign-on to internal apps	✓	✓	✓	✓	✓
Launchpad favorites (apps or remote access connections)	✓	✓	✓	✓	-
User attributes (ability for end users to edit)	✓	✓	✓	✓	✓
Dynamic firewall rule control (for system administrators)	✓	✓	✓	✓	✓
Custom help or info text for your organization	✓	✓	✓	✓	✓
Manually edit and create IP remote access connections	✓	✓	✓	✓	-
Debug log for easy support	✓	✓	✓	✓	-
Multi-factor authentication (up to 6 schemes)	✓	✓	✓	✓	✓
<b>SUPPORTED MULTI-FACTOR AUTHENTICATION SCHEMES</b>					
MS Active Directory	✓	✓	✓	✓	✓
LDAP	✓	✓	✓	✓	✓
Radius	✓	✓	✓	✓	✓
RSA SecurID	✓	✓	✓	✓	✓
TacPlus	✓	✓	✓	✓	✓
NGF Local	✓	✓	✓	✓	✓
MSNT	✓	✓	✓	✓	✓
Time-based OTP	✓	✓	✓	✓	✓

BARRACUDA FIREWALL CONTROL CENTER CONFIGURATION MANAGEMENT	STANDARD EDITION (VC400 / VCC400)	ENTERPRISE EDITION (VC610 / VCC610)	GLOBAL EDITION (VC820)
Tenants	1	1 <sup>[14]</sup>	5
Configuration groups <sup>[15]</sup>	1	Unlimited	Unlimited
Maximum managed gateways [recommended]	Unlimited [20]	Unlimited [200]	Unlimited [1,000+; dependings on HW]
Configuration templates (repositories)	✓	✓	✓
Shared configuration data	✓	✓	✓
Zero-touch deployment	✓	✓	✓
Operating system parameters	✓	✓	✓
Networking/routing parameters	✓	✓	✓
FW/SD-WAN/remote access policies, application gateway parameters	✓	✓	✓
Flat file data storage	✓	✓	✓
Database characteristics (transaction orientation, locking, etc.)	✓	✓	✓
Backup and restore functionality	✓	✓	✓
Gateway configuration archive for speed install	✓	✓	✓
Configuration update monitoring	✓	✓	✓
Full RCS versioning	✓	✓	✓
Graphical tunnel interface for SD-WAN	✓	✓	✓
Dynamic mesh site-to-site SD-WAN support	✓	✓	✓
Barracuda Network Access Client policy management	✓	✓	✓
Multi-release management	-	✓	✓
Multi-platform management	✓	✓	✓

BARRACUDA FIREWALL CONTROL CENTER STATUS MONITORING	STANDARD EDITION (VC400 / VCC400)	ENTERPRISE EDITION (VC610 / VCC610)	GLOBAL EDITION (VC820)
Gateway health state	✓	✓	✓
Launch pad functionality	✓	✓	✓
Customizable layout	✓	✓	✓

BARRACUDA FIREWALL CONTROL CENTER TRUST CENTER	STANDARD EDITION (VC400 / VCC400)	ENTERPRISE EDITION (VC610 / VCC610)	GLOBAL EDITION (VC820)
Gateway x.509 certificate CA	✓	✓	✓
Gateway SSH key management	✓	✓	✓
Server for management tunnels to gateways	✓	✓	✓
Virtual IP addresses for gateways (ProxyARP)	✓	✓	✓
Dynamic gateway IP address support	✓	✓	✓

BARRACUDA FIREWALL CONTROL CENTER LICENSE CENTER	STANDARD EDITION (VC400 / VCC400)	ENTERPRISE EDITION (VC610 / VCC610)	GLOBAL EDITION (VC820)
License timestamp server	✓	✓	✓
License status display	✓	✓	✓
Central event message list	✓	✓	✓
Event forwarding (SNMP, mail)	✓	✓	✓
Event log	✓	✓	✓

14 The public cloud edition VCC610 supports two tenants.

15 "Configuration Groups" ("cluster" in the firmware) refers to an administratively bundled group of CloudGen Firewall appliances and not to a load sharing cluster.



BARRACUDA FIREWALL CONTROL CENTER CENTRAL SOFTWARE UPDATE	STANDARD EDITION (VC400 / VCC400)	ENTERPRISE EDITION (VC610 / VCC610)	GLOBAL EDITION (VC820)
Real-time version display	✓	✓	✓
Kernel and OS updates	✓	✓	✓
Barracuda CloudGen Firewall updates & log viewer	✓	✓	✓

BARRACUDA FIREWALL CONTROL CENTER SECURE REMOTE EXEC. ENVIRONMENT (SSHV2)	STANDARD EDITION (VC400 / VCC400)	ENTERPRISE EDITION (VC610 / VCC610)	GLOBAL EDITION (VC820)
Job scheduling	✓	✓	✓
Script management	✓	✓	✓
Execution log viewer	✓	✓	✓

BARRACUDA FIREWALL CONTROL CENTER ADMINISTRATIVE MODEL	STANDARD EDITION (VC400 / VCC400)	ENTERPRISE EDITION (VC610 / VCC610)	GLOBAL EDITION (VC820)
Fully GUI-based access (Barracuda Firewall Admin management tool)	✓	✓	✓
Strong authentication & AES encryption	✓	✓	✓
Configurable role-based administration	✓	✓	✓
Adjustable view on configuration tree	✓	✓	✓
Configurable administrative domains	-	✓	✓
Multiple domains per administrator	-	✓	✓
Configurable access on OS level	✓	✓	✓
Configurable access notification	✓	✓	✓

BARRACUDA FIREWALL CONTROL CENTER REPORTING AND ACCOUNTING	STANDARD EDITION (VC400 / VCC400)	ENTERPRISE EDITION (VC610 / VCC610)	GLOBAL EDITION (VC820)
Historical reports on gateway activity	✓	✓	✓
Customer-based gateway activity reports	✓	✓	✓
Policy distribution	✓	✓	✓
Control Center resource utilization	✓	✓	✓
Gateway-resource utilization	✓	✓	✓
Central log host	✓	✓	✓
Streaming/relaying to external log host	✓	✓	✓
Barracuda Report Server integration	✓	✓	✓

BARRACUDA FIREWALL CONTROL CENTER ADDITIONAL FUNCTIONS	STANDARD EDITION (VC400 / VCC400)	ENTERPRISE EDITION (VC610 / VCC610)	GLOBAL EDITION (VC820)
NTP4 time server for gateways	✓	✓	✓
Integrated DNS server	✓	✓	✓
High availability	Optional	Optional	HA license included
SIEM syslog interface	✓	✓	✓
Public key infrastructure	-	✓	✓
Revision control system	✓	✓	✓
Access monitor	✓	✓	✓

BARRACUDA FIREWALL INSIGHTS	F12	F18	F80	F180	F280	F380	F400	F600	F800	F900	F1000	VIRTUAL
<b>AVAILABLE DASHBOARDS</b>												
SD-WAN dashboard	✓	✓	✓	✓	✓	✓	✓	✓	✓	✓	✓	✓
SD-WAN tunnel status dashboard	✓	✓	✓	✓	✓	✓	✓	✓	✓	✓	✓	✓
Security and web traffic dashboard	✓	✓	✓	✓	✓	✓	✓	✓	✓	✓	✓	✓
Network traffic dashboard	✓	✓	✓	✓	✓	✓	✓	✓	✓	✓	✓	✓
<b>GENERAL REPORT TYPES</b>												
Customizable reports	✓	✓	✓	✓	✓	✓	✓	✓	✓	✓	✓	✓
On-demand reports	✓	✓	✓	✓	✓	✓	✓	✓	✓	✓	✓	✓
Scheduled reports	✓	✓	✓	✓	✓	✓	✓	✓	✓	✓	✓	✓
<b>PRE-DEFINED REPORTS</b>												
Predefined productivity reports	✓	✓	✓	✓	✓	✓	✓	✓	✓	✓	✓	✓
Predefined web activity reports	✓	✓	✓	✓	✓	✓	✓	✓	✓	✓	✓	✓
Predefined safety and liability reports	✓	✓	✓	✓	✓	✓	✓	✓	✓	✓	✓	✓
Predefined network activity reports	✓	✓	✓	✓	✓	✓	✓	✓	✓	✓	✓	✓
Predefined threat and security reports	✓	✓	✓	✓	✓	✓	✓	✓	✓	✓	✓	✓
Predefined infection activity reports	✓	✓	✓	✓	✓	✓	✓	✓	✓	✓	✓	✓
Predefined traffic reports	✓	✓	✓	✓	✓	✓	✓	✓	✓	✓	✓	✓
<b>CLOUDGEN FIREWALL DASHBOARD</b>												
Overview of allowed and blocked sessions along with an explanation	✓	✓	✓	✓	✓	✓	✓	✓	✓	✓	✓	✓
Threats overview by user, source, and destination	✓	✓	✓	✓	✓	✓	✓	✓	✓	✓	✓	✓
Web activity and productivity: Categories, users, and domains accessed by number of requests, bandwidth, and browse time	✓	✓	✓	✓	✓	✓	✓	✓	✓	✓	✓	✓
<b>SUMMARY REPORTS</b>												
Safety and liability	✓	✓	✓	✓	✓	✓	✓	✓	✓	✓	✓	✓
Network activity	✓	✓	✓	✓	✓	✓	✓	✓	✓	✓	✓	✓
Threat summary	✓	✓	✓	✓	✓	✓	✓	✓	✓	✓	✓	✓
Web traffic summary	✓	✓	✓	✓	✓	✓	✓	✓	✓	✓	✓	✓
Total usage	✓	✓	✓	✓	✓	✓	✓	✓	✓	✓	✓	✓
<b>SAFETY AND LIABILITY REPORTS (BASED ON USER AND REQUESTS)</b>												
Traffic to adult-rated sites	✓	✓	✓	✓	✓	✓	✓	✓	✓	✓	✓	✓
Anonymizer sites	✓	✓	✓	✓	✓	✓	✓	✓	✓	✓	✓	✓
File-sharing and P2P	✓	✓	✓	✓	✓	✓	✓	✓	✓	✓	✓	✓
Intolerance and hate	✓	✓	✓	✓	✓	✓	✓	✓	✓	✓	✓	✓
Spyware	✓	✓	✓	✓	✓	✓	✓	✓	✓	✓	✓	✓
Violence and terrorism	✓	✓	✓	✓	✓	✓	✓	✓	✓	✓	✓	✓
Based on user and requests	✓	✓	✓	✓	✓	✓	✓	✓	✓	✓	✓	✓
<b>SECURITY REPORTS BY SUBTYPE (BASED ON USER, TIME, SOURCE IP, AND DESTINATION)</b>												
ATP	✓	✓	✓	✓	✓	✓	✓	✓	✓	✓	✓	✓
IPS	✓	✓	✓	✓	✓	✓	✓	✓	✓	✓	✓	✓
Virus	✓	✓	✓	✓	✓	✓	✓	✓	✓	✓	✓	✓
Malware	✓	✓	✓	✓	✓	✓	✓	✓	✓	✓	✓	✓
Spyware	✓	✓	✓	✓	✓	✓	✓	✓	✓	✓	✓	✓
Blocked file content	✓	✓	✓	✓	✓	✓	✓	✓	✓	✓	✓	✓
<b>OT, IIOT, AND SCADA REPORTS</b>												
Traffic summary	✓	✓	✓	✓	✓	✓	✓	✓	✓	✓	✓	✓
Traffic per protocol	✓	✓	✓	✓	✓	✓	✓	✓	✓	✓	✓	✓
SCADA traffic per hour or day (S7, S7+, DNP3, Modbus, IEC60870-5-104 traffic)	✓	✓	✓	✓	✓	✓	✓	✓	✓	✓	✓	✓



# Available subscriptions

## Availability matrix

CLOUDGEN FIREWALL	F12A	F18B	F80B	F180B	F280C	F380B	F400C	F600D	F800C	F900B	F1000B	F93A.R	F193A.R	SC2X	SC3X	VX	PUBLIC CLOUD	
																	BYOL	PAYG
<b>AVAILABLE SOFTWARE/FEATURE SUBSCRIPTIONS</b>																		
Energize Updates (EU)	Mandatory																–	–
Virtual subscription (incl. EU)	–	–	–	–	–	–	–	–	–	–	–	–	–	–	–	–	Mandatory	✓
Barracuda Firewall Insights	Optional													–	–	Optional	✓	
Malware Protection	Optional <sup>[16]</sup>													–	–	Optional	–	
Advanced Threat Protection	Optional													–	–	Optional	–	
Advanced Remote Access	–	Optional													–	–	Optional	✓
<b>AVAILABLE HARDWARE/SUPPORT SUBSCRIPTIONS</b>																		
Warranty Extension	Optional															–	–	–
Instant Replacement	Optional															–	–	–
Premium Support	on request							Optional							–	–	Optional	–
On-site cold spare unit	Optional															–	–	–

### High Availability (“HA”):

All subscriptions have to be licensed separately for the HA partner. For further information, please contact your local partner or Barracuda Sales at [sales@barracuda.com](mailto:sales@barracuda.com).

## Energize Updates

Barracuda Energize Updates help you secure your investment in the ever-changing IT world. Benefit from security updates to patch or repair any security vulnerabilities, keep your Barracuda product up-to-date and fully functional at all times, and get access to our award-winning support.

Energize Updates are available for all CloudGen Firewall hardware and virtual models. Available for up to 5 years. Purchasing at least 12 months of Energize Updates is required with every CloudGen Firewall.

Energize Updates includes:

- Enhanced support providing 24x7 technical support via phone, live chat, online portal, and e-mail
- Firmware maintenance including new firmware updates with feature enhancements and bug fixes
- Early Release Firmware program (optional)
- Unlimited number of remote access connections
- Security updates to patch/repair any security vulnerabilities
- URL filter based on Barracuda Web Filter online URL categorization in single-pass as well as in proxy mode
- Regular updates for Application Control database
- IPS signature and pattern updates
- Barracuda CloudGen Access support.

16 For model F12A, malware protection utilizes cloud-based malware protection as part of an active Advanced Threat Protection subscription.

## Barracuda Firewall Insights

Barracuda Firewall Insights allows to consolidate security, application flow, and connectivity information from hundreds or even thousands of firewalls on the extended WAN – regardless of whether they are hardware, virtual, or cross-cloud-based deployments.

For a Firewall Insights deployment, every device requires an active Firewall Insights subscription and access to the central Firewall Insights server.

Firewall Insights server is available as a virtual image for KVM, VMWare, and Hyper-V with the following requirements:

SSD data size: Unlimited (min. 2 TB)

RAM: Unlimited (min. 32 GB)

CPU cores: Unlimited (min. 8)

IOPS: Unlimited (min. 24,000)

## On-Site Cold Spare Unit

The cold spare unit provides Barracuda customers a cold standby appliance of the same type as the main unit.

This cold standby unit can be activated quickly in case the active unit fails for any reason. The cold standby appliance includes a “Cold Standby License” for CloudGen Firewall firmware only; no productive use for firewalling or other functions is possible. In this way, the firmware of the appliance can be upgraded to the patch level that corresponds to the main unit (fully licensed unit). If the main unit fails, the on-site cold spare unit may be used to temporarily host the license and backup file (“par” file, including the license) of the defective main unit for a period of up to 15 days.

If the defective unit is covered under Instant Replacement or is still under warranty, Barracuda Networks will ship the customer a replacement unit of the same type as the defective unit. The former cold spare unit inherits the license features of the former main unit by a swap with a new license issued, effectively transforming the cold spare to the new main unit. The shipped unit includes a cold spare license and effectively become the new cold spare.

The customer needs to ship the defective unit to Barracuda Networks or certify destruction. If the customer fails to do so, Barracuda reserves the right to charge the customer for a full CloudGen Firewall deployment.



## Warranty Extension

Provides an extended warranty, and ships a replacement unit on the next business day (best effort) with standard mail upon notification of a failed unit.

Must be purchased within 60 days of hardware purchase and is a continuous subscription from date of activation. Available for up to 3 years.

## Instant Replacement

One hundred percent uptime is important in corporate environments, but sometimes equipment can fail. In the rare case that a Barracuda product fails, Barracuda ships a replacement unit on the same or next business day. And by means of the Hardware Refresh Program, we ensure that customers benefit from the latest hardware improvements and firmware capabilities:

- Enhanced support providing phone and email support 24/7
- Hard disk replacement on models that have swappable RAID drives
- Free hardware refresh after four years of continuous IR coverage.

Must be purchased within 60 days of hardware purchase and is a continuous subscription from date of activation. Available for up to 5 years.

## Comparison “Warranty Extension - Instant Replacement”

	WARRANTY EXTENSION	INSTANT REPLACEMENT
Replacement	Next business day (best effort)	Same day or next business day
Shipment	Standard	Express
Hard disk replacement (swappable RAID)	Standard shipping	Standard shipping
Support	Basic support (with EU)	Enhanced support
Available subscriptions	up to 3 years	up to 5 years
Free hardware refresh after 4 years	-	✓

## Premium Support

Premium Support ensures that an organisation's network is running at its peak performance by providing the highest level of 24/7 technical support for mission-critical environments. A dedicated Premium Support Account Manager and a team of technical engineers provide fast solutions to high-priority support issues, thereby ensuring that Barracuda Networks equipment maintains continuous uptime.

### Key benefits of Premium Support:

- Dedicated phone and email support 24/7
- Priority response time to resolve mission-critical issues
- Priority Level Agreement (PLAs) to guarantee that issues are handled, resolved, and closed quickly
- Dedicated Support Account Manager who is familiar with the customer's environment
- Proactive ticket monitoring and reporting to provide comprehensive information and control

#### Note:

Available for all CloudGen Firewall hardware and virtual models. Premium Support for CloudGen Firewall hardware appliances can only be purchased in combination with Instant Replacement. Premium Support may be purchased on CloudGen Firewall virtual appliances without Instant Replacement. Available for up to 5 years.

For more information on Premium Support, please visit [www.barracuda.com/support](http://www.barracuda.com/support).

## Advanced Remote Access

This optional subscription adds a customizable and easy-to-use browser-based remote access, sophisticated Network Access Control (NAC) functionality, and CudaLaunch support.

**CudaLaunch** is a simple-to-use remote connectivity application specifically designed to securely extend the company network to BYOD and mobile devices. The app is available for Windows, macOS, iOS, and Android, can be downloaded from the App Stores.

The Barracuda **Network Access Client** provides a sophisticated remote access client for Windows, macOS, and Linux that provides richer performance and functionality than standard IPsec client software. The Barracuda Network Access Client, when used with a CloudGen Firewall, provides centrally managed Network Access Control (NAC) and an advanced Personal Firewall. This enforces client health and security policies for remote users connecting to the corporate network.

For CloudGen Firewall deployments in public cloud offerings like Amazon Web Services and/or Azure with Pay-As-You-Go licencing, this subscription is included.

### User Session Limits

- Unlimited concurrent CudaLaunch sessions
- Multiple concurrent remote access sessions by the same user



## Advanced Threat Protection

Prevent malicious files—even unknown ones—from entering the organization. Avoid network breaches, identify zero-day malware exploits, targeted attacks, advanced persistent threats and other advanced malware that routinely bypass traditional signature based IPS and antivirus engines before they do harm to your network.

### Compatibility and licensing:

Available for CloudGen Firewall models F18B and higher, as well as all CloudGen Firewall virtual appliances.

Available for up to 5 years. Requires a valid Web Security or Malware Protection subscription.

In case the monthly file capacity is reached, the system stops forwarding files to the ATP cloud for the rest of the current month.

## Malware Protection

The Malware Protection subscription provides gateway-based protection against malware, viruses, spyware, and other unwanted programs inside SMTP/S, HTTP/S, POP3/S, FTP, and SFTP traffic.

Key Benefits of Malware Protection:

- Configurable archive recursion depth
- Quarantine functionality for proxy
- Configurable unknown archive policy
- Configurable maximum archive size
- Archiver package support
- Office file-types support
- Proactive detection of new threats
- Advanced heuristics detection techniques
- Hundreds of thousands signatures

CloudGen Firewall model F12A features online malware protection as part of this subscription.

### Compatibility and licensing:

Available for CloudGen Firewall models F12A and higher, as well as all CloudGen Firewall virtual appliances. Unlimited user license if purchased with a CloudGen Firewall hardware appliance. If purchased for a virtual appliance the number of protected IPs (capacity) applies.

Available for up to 5 years.

In High Availability (HA) environments each unit needs to be licensed separately.

# Ordering information

## Barracuda CloudGen Firewall

### Calculation of co-terminus subscriptions:

To allow customers to consolidate their maintenance and subscription offerings to a single end or renewal date, daily rates for all subscription types are offered. These daily rates should be used to extend expiring subscriptions to coincide with the dates of subscriptions expiring in the future. Barracuda does credit early termination of subscriptions using these daily rates.

### Hardware appliances - Entry level / branch offices

CLOUDGEN FIREWALL F12A	SKU
Barracuda CloudGen Firewall F12A hardware unit	BNGF12A
Energize Updates (monthly; for up to 5 years)	BNGF12A-e<duration>
Instant Replacement (monthly; for up to 5 years)	BNGF12A-h<duration>
Warranty extension (monthly; for up to 3 years)	BNGF12A-we<duration>
Premium Support (monthly; for up to 5 years)	BNGF12A-p<duration>
Advanced Threat Protection (monthly; for up to 5 years)	BNGF12A-a<duration>
Firewall Insights (monthly; for up to 5 years)	BNGF12A-fi<duration>
Cold spare F12A	BNGF12A--c
L-shape Rack Mount Bracket (2x)	BPRAC-05
USB modem 4G/LTE (Europe / International)	BNGM40a
USB modem 4G/LTE Instant Replacement (monthly; for up to 5 years)	BNGM40a-h<duration>
USB modem 4G/LTE Warranty extension (monthly; for up to 3 years)	BNGM40a-we<duration>
USB modem 4G/LTE (North America)	BNGM41a
USB modem 4G/LTE Instant Replacement (monthly; for up to 5 years)	BNGM41a-h<duration>
USB modem 4G/LTE Warranty extension (monthly; for up to 3 years)	BNGM41a-we<duration>
USB modem 4G/LTE (Verizon)	BNGM42a
USB modem 4G/LTE Instant Replacement (monthly; for up to 5 years)	BNGM42a-h<duration>
USB modem 4G/LTE Warranty extension (monthly; for up to 3 years)	BNGM42a-we<duration>

CLOUDGEN FIREWALL F18B	SKU
Barracuda CloudGen Firewall F18B hardware unit	BNGF18B
Energize Updates (monthly; for up to 5 years)	BNGF18B-e<duration>
Instant Replacement (monthly; for up to 5 years)	BNGF18B-h<duration>
Warranty extension (monthly; for up to 3 years)	BNGF18B-we<duration>
Premium Support (monthly; for up to 5 years)	BNGF18B-p<duration>
Malware Protection (monthly; for up to 5 years)	BNGF18B-m<duration>
Advanced Threat Protection (monthly; for up to 5 years)	BNGF18B-a<duration>
Advanced Remote Access (monthly; for up to 5 years)	BNGF18B-vp<duration>
Firewall Insights (monthly; for up to 5 years)	BNGF18B-fi<duration>
Cold spare F18B	BNGF18B--c
L-shape Rack Mount Bracket (2x)	BPRAC-04
USB modem 4G/LTE (Europe / International)	BNGM40a
USB modem 4G/LTE Instant Replacement (monthly; for up to 5 years)	BNGM40a-h<duration>
USB modem 4G/LTE Warranty extension (monthly; for up to 3 years)	BNGM40a-we<duration>
USB modem 4G/LTE (North America)	BNGM41a
USB modem 4G/LTE Instant Replacement (monthly; for up to 5 years)	BNGM41a-h<duration>
USB modem 4G/LTE Warranty extension (monthly; for up to 3 years)	BNGM41a-we<duration>
USB modem 4G/LTE (Verizon)	BNGM42a
USB modem 4G/LTE Instant Replacement (monthly; for up to 5 years)	BNGM42a-h<duration>
USB modem 4G/LTE Warranty extension (monthly; for up to 3 years)	BNGM42a-we<duration>

CLOUDGEN FIREWALL F80B	SKU
Barracuda CloudGen Firewall F80B hardware unit	BNGF80B
Energize Updates (monthly; for up to 5 years)	BNGF80B-e<duration>
Instant Replacement (monthly; for up to 5 years)	BNGF80B-h<duration>
Warranty extension (monthly; for up to 3 years)	BNGF80B-we<duration>
Premium Support (monthly; for up to 5 years)	BNGF80B-p<duration>
Malware Protection (monthly; for up to 5 years)	BNGF80B-m<duration>
Advanced Threat Protection (monthly; for up to 5 years)	BNGF80B-a<duration>
Advanced Remote Access (monthly; for up to 5 years)	BNGF80B-vp<duration>
Firewall Insights (monthly; for up to 5 years)	BNGF80B-fi<duration>
Cold spare F80B	BNGF80B--c
L-shape Rack Mount Bracket (2x)	BNGF80B.RK015
Barracuda External Power Supply Adapter	BNGF80B.PA008
USB modem 4G/LTE (Europe / International)	BNGM40a
USB modem 4G/LTE Instant Replacement (monthly; for up to 5 years)	BNGM40a-h<duration>
USB modem 4G/LTE Warranty extension (monthly; for up to 3 years)	BNGM40a-we<duration>
USB modem 4G/LTE (North America)	BNGM41a
USB modem 4G/LTE Instant Replacement (monthly; for up to 5 years)	BNGM41a-h<duration>
USB modem 4G/LTE Warranty extension (monthly; for up to 3 years)	BNGM41a-we<duration>
USB modem 4G/LTE (Verizon)	BNGM42a
USB modem 4G/LTE Instant Replacement (monthly; for up to 5 years)	BNGM42a-h<duration>
USB modem 4G/LTE Warranty extension (monthly; for up to 3 years)	BNGM42a-we<duration>

CLOUDGEN FIREWALL F180B	SKU
Barracuda CloudGen Firewall F180B hardware unit	BNGF180B
Energize Updates (monthly; for up to 5 years)	BNGF180B-e<duration>
Instant Replacement (monthly; for up to 5 years)	BNGF180B-h<duration>
Warranty extension (monthly; for up to 3 years)	BNGF180B-we<duration>
Premium Support (monthly; for up to 5 years)	BNGF180B-p<duration>
Malware Protection (monthly; for up to 5 years)	BNGF180B-m<duration>
Advanced Threat Protection (monthly; for up to 5 years)	BNGF180B-a<duration>
Advanced Remote Access (monthly; for up to 5 years)	BNGF180B-vp<duration>
Firewall Insights (monthly; for up to 5 years)	BNGF180B-fi<duration>
Cold spare F180B	BNGF180B--c
USB modem 4G/LTE (Europe / International)	BNGM40a
USB modem 4G/LTE Instant Replacement (monthly; for up to 5 years)	BNGM40a-h<duration>
USB modem 4G/LTE Warranty extension (monthly; for up to 3 years)	BNGM40a-we<duration>
USB modem 4G/LTE (North America)	BNGM41a
USB modem 4G/LTE Instant Replacement (monthly; for up to 5 years)	BNGM41a-h<duration>
USB modem 4G/LTE Warranty extension (monthly; for up to 3 years)	BNGM41a-we<duration>
USB modem 4G/LTE (Verizon)	BNGM42a
USB modem 4G/LTE Instant Replacement (monthly; for up to 5 years)	BNGM42a-h<duration>
USB modem 4G/LTE Warranty extension (monthly; for up to 3 years)	BNGM42a-we<duration>



CLOUDGEN FIREWALL F280C	SKU
Barracuda CloudGen Firewall F280C hardware unit	BNGF280C
Energize Updates (monthly; for up to 5 years)	BNGF280C-e<duration>
Instant Replacement (monthly; for up to 5 years)	BNGF280C-h<duration>
Warranty extension (monthly; for up to 3 years)	BNGF280C-we<duration>
Premium Support (monthly; for up to 5 years)	BNGF280C-p<duration>
Malware Protection (monthly; for up to 5 years)	BNGF280C-m<duration>
Advanced Threat Protection (monthly; for up to 5 years)	BNGF280C-a<duration>
Advanced Remote Access (monthly; for up to 5 years)	BNGF280C-vp<duration>
Firewall Insights (monthly; for up to 5 years)	BNGF280C-fi<duration>
Cold spare F280C	BNGF280C--c

CLOUDGEN FIREWALL F280C	SKU
USB modem 4G/LTE (Europe / International)	BNGM40a
USB modem 4G/LTE Instant Replacement (monthly; for up to 5 years)	BNGM40a-h<duration>
USB modem 4G/LTE Warranty extension (monthly; for up to 3 years)	BNGM40a-we<duration>
USB modem 4G/LTE (North America)	BNGM41a
USB modem 4G/LTE Instant Replacement (monthly; for up to 5 years)	BNGM41a-h<duration>
USB modem 4G/LTE Warranty extension (monthly; for up to 3 years)	BNGM41a-we<duration>
USB modem 4G/LTE (Verizon)	BNGM42a
USB modem 4G/LTE Instant Replacement (monthly; for up to 5 years)	BNGM42a-h<duration>
USB modem 4G/LTE Warranty extension (monthly; for up to 3 years)	BNGM42a-we<duration>

## Hardware appliances - Mid-range

CLOUDGEN FIREWALL F380B	SKU
Barracuda CloudGen Firewall F380B hardware unit	BNGF380B
Energize Updates (monthly; for up to 5 years)	BNGF380B-e<duration>
Instant Replacement (monthly; for up to 5 years)	BNGF380B-h<duration>
Warranty extension (monthly; for up to 3 years)	BNGF380B-we<duration>
Premium Support (monthly; for up to 5 years)	BNGF380B-p<duration>
Malware Protection (monthly; for up to 5 years)	BNGF380B-m<duration>
Advanced Threat Protection (monthly; for up to 5 years)	BNGF380B-a<duration>
Advanced Remote Access (monthly; for up to 5 years)	BNGF380B-vp<duration>
Firewall Insights (monthly; for up to 5 years)	BNGF380B-fi<duration>
Cold spare F380B	BNGF380B--c
Rail kit	BNGF380B.RK017
USB modem 4G/LTE (Europe / International)	BNGM40a
USB modem 4G/LTE Instant Replacement (monthly; for up to 5 years)	BNGM40a-h<duration>
USB modem 4G/LTE Warranty extension (monthly; for up to 3 years)	BNGM40a-we<duration>
USB modem 4G/LTE (North America)	BNGM41a
USB modem 4G/LTE Instant Replacement (monthly; for up to 5 years)	BNGM41a-h<duration>
USB modem 4G/LTE Warranty extension (monthly; for up to 3 years)	BNGM41a-we<duration>
USB modem 4G/LTE (Verizon)	BNGM42a
USB modem 4G/LTE Instant Replacement (monthly; for up to 5 years)	BNGM42a-h<duration>
USB modem 4G/LTE Warranty extension (monthly; for up to 3 years)	BNGM42a-we<duration>

CLOUDGEN FIREWALL F400C STANDARD MODEL	SKU
Barracuda CloudGen Firewall F400C standard model hardware unit	BNGF400C
Energize Updates (monthly; for up to 5 years)	BNGF400C-e<duration>
Instant Replacement (monthly; for up to 5 years)	BNGF400C-h<duration>
Warranty extension (monthly; for up to 3 years)	BNGF400C-we<duration>
Premium Support (monthly; for up to 5 years)	BNGF400C-p<duration>
Malware Protection (monthly; for up to 5 years)	BNGF400C-m<duration>
Advanced Threat Protection (monthly; for up to 5 years)	BNGF400C-a<duration>
Advanced Remote Access (monthly; for up to 5 years)	BNGF400C-vp<duration>
Firewall Insights (monthly; for up to 5 years)	BNGF400C-fi<duration>
Cold spare F400C standard model	BNGF400C--c
Rail kit	BNGF400C.RK017
USB modem 4G/LTE (Europe / International)	BNGM40a
USB modem 4G/LTE Instant Replacement (monthly; for up to 5 years)	BNGM40a-h<duration>
USB modem 4G/LTE Warranty extension (monthly; for up to 3 years)	BNGM40a-we<duration>
USB modem 4G/LTE (North America)	BNGM41a
USB modem 4G/LTE Instant Replacement (monthly; for up to 5 years)	BNGM41a-h<duration>
USB modem 4G/LTE Warranty extension (monthly; for up to 3 years)	BNGM41a-we<duration>
USB modem 4G/LTE (Verizon)	BNGM42a
USB modem 4G/LTE Instant Replacement (monthly; for up to 5 years)	BNGM42a-h<duration>
USB modem 4G/LTE Warranty extension (monthly; for up to 3 years)	BNGM42a-we<duration>

CLOUDGEN FIREWALL F400C.F20	SKU
Barracuda CloudGen Firewall F400C.F20 hardware unit	BNGF400C.F20
Energize Updates (monthly; for up to 5 years)	BNGF400C.F20-e<duration>
Instant Replacement (monthly; for up to 5 years)	BNGF400C.F20-h<duration>
Warranty extension (monthly; for up to 3 years)	BNGF400C.F20-we<duration>
Premium Support (monthly; for up to 5 years)	BNGF400C.F20-p<duration>
Malware Protection (monthly; for up to 5 years)	BNGF400C.F20-m<duration>
Advanced Threat Protection (monthly; for up to 5 years)	BNGF400C.F20-a<duration>
Advanced Remote Access (monthly; for up to 5 years)	BNGF400C.F20-vp<duration>
Firewall Insights (monthly; for up to 5 years)	BNGF400C.F20-fi<duration>
Spare power supply	BNGF400C.PS022
Cold spare F400C.F20	BNGF400C.F20--c
Rail kit	BNGF400C.RK017
USB modem 4G/LTE (Europe / International)	BNGM40a
USB modem 4G/LTE Instant Replacement (monthly; for up to 5 years)	BNGM40a-h<duration>
USB modem 4G/LTE Warranty extension (monthly; for up to 3 years)	BNGM40a-we<duration>
USB modem 4G/LTE (North America)	BNGM41a
USB modem 4G/LTE Instant Replacement (monthly; for up to 5 years)	BNGM41a-h<duration>
USB modem 4G/LTE Warranty extension (monthly; for up to 3 years)	BNGM41a-we<duration>
USB modem 4G/LTE (Verizon)	BNGM42a
USB modem 4G/LTE Instant Replacement (monthly; for up to 5 years)	BNGM42a-h<duration>
USB modem 4G/LTE Warranty extension (monthly; for up to 3 years)	BNGM42a-we<duration>

CLOUDGEN FIREWALL F600D.C10	SKU
Barracuda CloudGen Firewall F600D.C10 hardware unit	BNGF600D.C10
Energize Updates (monthly; for up to 5 years)	BNGF600D.C10-e<duration>
Instant Replacement (monthly; for up to 5 years)	BNGF600D.C10-h<duration>
Warranty extension (monthly; for up to 3 years)	BNGF600D.C10-we<duration>
Premium Support (monthly; for up to 5 years)	BNGF600D.C10-p<duration>
Malware Protection (monthly; for up to 5 years)	BNGF600D.C10-m<duration>
Advanced Threat Protection (monthly; for up to 5 years)	BNGF600D.C10-a<duration>
Advanced Remote Access (monthly; for up to 5 years)	BNGF600D.C10-vp<duration>
Firewall Insights (monthly; for up to 5 years)	BNGF600D.C10-fi<duration>
Cold spare F600D.C10	BNGF600D.C10--c
Replacement / spare network module 8x1 GbE Copper	BNGF600D.ET089
Replacement / spare network module 8x1 GbE SFP	BNGF600D.ET074
Replacement / spare network module 2x10 GbE SFP+	BNGF600D.ET091
Rail kit	BNGF600D.RK017
USB modem 4G/LTE (Europe / International)	BNGM40a
USB modem 4G/LTE Instant Replacement (monthly; for up to 5 years)	BNGM40a-h<duration>
USB modem 4G/LTE Warranty extension (monthly; for up to 3 years)	BNGM40a-we<duration>
USB modem 4G/LTE (North America)	BNGM41a
USB modem 4G/LTE Instant Replacement (monthly; for up to 5 years)	BNGM41a-h<duration>
USB modem 4G/LTE Warranty extension (monthly; for up to 3 years)	BNGM41a-we<duration>
USB modem 4G/LTE (Verizon)	BNGM42a
USB modem 4G/LTE Instant Replacement (monthly; for up to 5 years)	BNGM42a-h<duration>
USB modem 4G/LTE Warranty extension (monthly; for up to 3 years)	BNGM42a-we<duration>

CLOUDGEN FIREWALL F600D.C20	SKU
Barracuda CloudGen Firewall F600D.C20 hardware unit	BNGF600D.C20
Energize Updates (monthly; for up to 5 years)	BNGF600D.C20-e<duration>
Instant Replacement (monthly; for up to 5 years)	BNGF600D.C20-h<duration>
Warranty extension (monthly; for up to 3 years)	BNGF600D.C20-we<duration>
Premium Support (monthly; for up to 5 years)	BNGF600D.C20-p<duration>
Malware Protection (monthly; for up to 5 years)	BNGF600D.C20-m<duration>
Advanced Threat Protection (monthly; for up to 5 years)	BNGF600D.C20-a<duration>
Advanced Remote Access (monthly; for up to 5 years)	BNGF600D.C20-vp<duration>
Firewall Insights (monthly; for up to 5 years)	BNGF600D.C20-fi<duration>
Spare power supply	BNGF600D.PS022
Cold spare F600D.C20	BNGF600D.C20--c
Replacement / spare network module 8x1 GbE Copper	BNGF600D.ET089
Replacement / spare network module 8x1 GbE SFP	BNGF600D.ET074
Replacement / spare network module 2x10 GbE SFP+	BNGF600D.ET091
Rail kit	BNGF600D.RK017
USB modem 4G/LTE (Europe / International)	BNGM40a
USB modem 4G/LTE Instant Replacement (monthly; for up to 5 years)	BNGM40a-h<duration>
USB modem 4G/LTE Warranty extension (monthly; for up to 3 years)	BNGM40a-we<duration>
USB modem 4G/LTE (North America)	BNGM41a
USB modem 4G/LTE Instant Replacement (monthly; for up to 5 years)	BNGM41a-h<duration>
USB modem 4G/LTE Warranty extension (monthly; for up to 3 years)	BNGM41a-we<duration>
USB modem 4G/LTE (Verizon)	BNGM42a
USB modem 4G/LTE Instant Replacement (monthly; for up to 5 years)	BNGM42a-h<duration>
USB modem 4G/LTE Warranty extension (monthly; for up to 3 years)	BNGM42a-we<duration>

CLOUDGEN FIREWALL F600D.F10	SKU
Barracuda CloudGen Firewall F600D.F10 hardware unit	BNGF600D.F10
Energize Updates (monthly; for up to 5 years)	BNGF600D.F10-e<duration>
Instant Replacement (monthly; for up to 5 years)	BNGF600D.F10-h<duration>
Warranty extension (monthly; for up to 3 years)	BNGF600D.F10-we<duration>
Premium Support (monthly; for up to 5 years)	BNGF600D.F10-p<duration>
Malware Protection (monthly; for up to 5 years)	BNGF600D.F10-m<duration>
Advanced Threat Protection (monthly; for up to 5 years)	BNGF600D.F10-a<duration>
Advanced Remote Access (monthly; for up to 5 years)	BNGF600D.F10-vp<duration>
Firewall Insights (monthly; for up to 5 years)	BNGF600D.F10-fi<duration>
Cold spare F600D.F10	BNGF600D.F10--c
Replacement / spare network module 8x1 GbE Copper	BNGF600D.ET089
Replacement / spare network module 8x1 GbE SFP	BNGF600D.ET074
Replacement / spare network module 2x10 GbE SFP+	BNGF600D.ET091
Rail kit	BNGF600D.RK017
USB modem 4G/LTE (Europe / International)	BNGM40a
USB modem 4G/LTE Instant Replacement (monthly; for up to 5 years)	BNGM40a-h<duration>
USB modem 4G/LTE Warranty extension (monthly; for up to 3 years)	BNGM40a-we<duration>
USB modem 4G/LTE (North America)	BNGM41a
USB modem 4G/LTE Instant Replacement (monthly; for up to 5 years)	BNGM41a-h<duration>
USB modem 4G/LTE Warranty extension (monthly; for up to 3 years)	BNGM41a-we<duration>
USB modem 4G/LTE (Verizon)	BNGM42a
USB modem 4G/LTE Instant Replacement (monthly; for up to 5 years)	BNGM42a-h<duration>
USB modem 4G/LTE Warranty extension (monthly; for up to 3 years)	BNGM42a-we<duration>



CLLOUDGEN FIREWALL F600D.F20	SKU
Barracuda CloudGen Firewall F600D.F20 hardware unit	BNGF600D.F20
Energize Updates (monthly; for up to 5 years)	BNGF600D.F20-e<duration>
Instant Replacement (monthly; for up to 5 years)	BNGF600D.F20-h<duration>
Warranty extension (monthly; for up to 3 years)	BNGF600D.F20-we<duration>
Premium Support (monthly; for up to 5 years)	BNGF600D.F20-p<duration>
Malware Protection (monthly; for up to 5 years)	BNGF600D.F20-m<duration>
Advanced Threat Protection (monthly; for up to 5 years)	BNGF600D.F20-a<duration>
Advanced Remote Access (monthly; for up to 5 years)	BNGF600D.F20-vp<duration>
Firewall Insights (monthly; for up to 5 years)	BNGF600D.F20-fi<duration>
Spare power supply	BNGF600D.PS022
Cold spare F600D.F20	BNGF600D.F20--c
Replacement / spare network module 8x1 GbE Copper	BNGF600D.ET089
Replacement / spare network module 8x1 GbE SFP	BNGF600D.ET074
Replacement / spare network module 2x10 GbE SFP+	BNGF600D.ET091
Rail kit	BNGF600D.RK017
USB modem 4G/LTE (Europe / International)	BNGM40a
USB modem 4G/LTE Instant Replacement (monthly; for up to 5 years)	BNGM40a-h<duration>
USB modem 4G/LTE Warranty extension (monthly; for up to 3 years)	BNGM40a-we<duration>
USB modem 4G/LTE (North America)	BNGM41a
USB modem 4G/LTE Instant Replacement (monthly; for up to 5 years)	BNGM41a-h<duration>
USB modem 4G/LTE Warranty extension (monthly; for up to 3 years)	BNGM41a-we<duration>
USB modem 4G/LTE (Verizon)	BNGM42a
USB modem 4G/LTE Instant Replacement (monthly; for up to 5 years)	BNGM42a-h<duration>
USB modem 4G/LTE Warranty extension (monthly; for up to 3 years)	BNGM42a-we<duration>

CLLOUDGEN FIREWALL F600D.E20	SKU
Barracuda CloudGen Firewall F600D.E20 hardware unit	BNGF600D.E20
Energize Updates (monthly; for up to 5 years)	BNGF600D.E20-e<duration>
Instant Replacement (monthly; for up to 5 years)	BNGF600D.E20-h<duration>
Warranty extension (monthly; for up to 3 years)	BNGF600D.E20-we<duration>
Premium Support (monthly; for up to 5 years)	BNGF600D.E20-p<duration>
Malware Protection (monthly; for up to 5 years)	BNGF600D.E20-m<duration>
Advanced Threat Protection (monthly; for up to 5 years)	BNGF600D.E20-a<duration>
Advanced Remote Access (monthly; for up to 5 years)	BNGF600D.E20-vp<duration>
Firewall Insights (monthly; for up to 5 years)	BNGF600D.E20-fi<duration>
Spare power supply	BNGF600D.PS022
Cold spare F600D.E20	BNGF600D.E20--c
Replacement / spare network module 8x1 GbE Copper	BNGF600D.ET089
Replacement / spare network module 8x1 GbE SFP	BNGF600D.ET074
Replacement / spare network module 2x10 GbE SFP+	BNGF600D.ET091
Rail kit	BNGF600D.RK017
USB modem 4G/LTE (Europe / International)	BNGM40a
USB modem 4G/LTE Instant Replacement (monthly; for up to 5 years)	BNGM40a-h<duration>
USB modem 4G/LTE Warranty extension (monthly; for up to 3 years)	BNGM40a-we<duration>
USB modem 4G/LTE (North America)	BNGM41a
USB modem 4G/LTE Instant Replacement (monthly; for up to 5 years)	BNGM41a-h<duration>
USB modem 4G/LTE Warranty extension (monthly; for up to 3 years)	BNGM41a-we<duration>
USB modem 4G/LTE (Verizon)	BNGM42a
USB modem 4G/LTE Instant Replacement (monthly; for up to 5 years)	BNGM42a-h<duration>
USB modem 4G/LTE Warranty extension (monthly; for up to 3 years)	BNGM42a-we<duration>

## Hardware appliances - High-end

CLOUDGEN FIREWALL F800C.CCC	SKU
Barracuda CloudGen Firewall F800C.CCC hardware unit	BNGF800A.CCC
Energize Updates (monthly; for up to 5 years)	BNGF800A.CCC-e<duration>
Instant Replacement (monthly; for up to 5 years)	BNGF800A.CCC-h<duration>
Warranty extension (monthly; for up to 3 years)	BNGF800A.CCC-we<duration>
Premium Support (monthly; for up to 5 years)	BNGF800A.CCC-p<duration>
Malware Protection (monthly; for up to 5 years)	BNGF800A.CCC-m<duration>
Advanced Threat Protection (monthly; for up to 5 years)	BNGF800A.CCC-a<duration>
Advanced Remote Access (monthly; for up to 5 years)	BNGF800A.CCC-vp<duration>
Firewall Insights (monthly; for up to 5 years)	BNGF800A.CCC-fi<duration>
Spare power supply	BNGIRPS2a
Cold spare F800C.CCC	BNGF800A.CCC--c
Replacement / spare network module 8x1 GbE Copper	BNGM806a
Replacement / spare network module 8x1 GbE SFP	BNGM807a
Replacement / spare network module 4x10 GbE SFP+	BNGM808a
USB modem 4G/LTE (Europe / International)	BNGM40a
USB modem 4G/LTE Instant Replacement (monthly; for up to 5 years)	BNGM40a-h<duration>
USB modem 4G/LTE Warranty extension (monthly; for up to 3 years)	BNGM40a-we<duration>
USB modem 4G/LTE (North America)	BNGM41a
USB modem 4G/LTE Instant Replacement (monthly; for up to 5 years)	BNGM41a-h<duration>
USB modem 4G/LTE Warranty extension (monthly; for up to 3 years)	BNGM41a-we<duration>
USB modem 4G/LTE (Verizon)	BNGM42a
USB modem 4G/LTE Instant Replacement (monthly; for up to 5 years)	BNGM42a-h<duration>
USB modem 4G/LTE Warranty extension (monthly; for up to 3 years)	BNGM42a-we<duration>

CLOUDGEN FIREWALL F800C.CCE	SKU
Barracuda CloudGen Firewall F800C.CCE hardware unit	BNGF800A.CCE
Energize Updates (monthly; for up to 5 years)	BNGF800A.CCE-e<duration>
Instant Replacement (monthly; for up to 5 years)	BNGF800A.CCE-h<duration>
Warranty extension (monthly; for up to 3 years)	BNGF800A.CCE-we<duration>
Premium Support (monthly; for up to 5 years)	BNGF800A.CCE-p<duration>
Malware Protection (monthly; for up to 5 years)	BNGF800A.CCE-m<duration>
Advanced Threat Protection (monthly; for up to 5 years)	BNGF800A.CCE-a<duration>
Advanced Remote Access (monthly; for up to 5 years)	BNGF800A.CCE-vp<duration>
Firewall Insights (monthly; for up to 5 years)	BNGF800A.CCE-fi<duration>
Spare power supply	BNGIRPS2a
Cold spare F800C.CCE	BNGF800A.CCE--c
Replacement / spare network module 8x1 GbE Copper	BNGM806a
Replacement / spare network module 8x1 GbE SFP	BNGM807a
Replacement / spare network module 4x10 GbE SFP+	BNGM808a
USB modem 4G/LTE (Europe / International)	BNGM40a
USB modem 4G/LTE Instant Replacement (monthly; for up to 5 years)	BNGM40a-h<duration>
USB modem 4G/LTE Warranty extension (monthly; for up to 3 years)	BNGM40a-we<duration>
USB modem 4G/LTE (North America)	BNGM41a
USB modem 4G/LTE Instant Replacement (monthly; for up to 5 years)	BNGM41a-h<duration>
USB modem 4G/LTE Warranty extension (monthly; for up to 3 years)	BNGM41a-we<duration>
USB modem 4G/LTE (Verizon)	BNGM42a
USB modem 4G/LTE Instant Replacement (monthly; for up to 5 years)	BNGM42a-h<duration>
USB modem 4G/LTE Warranty extension (monthly; for up to 3 years)	BNGM42a-we<duration>

CLOUDGEN FIREWALL F800C.CCF	SKU
Barracuda CloudGen Firewall F800C.CCF hardware unit	BNGF800A.CCF
Energize Updates (monthly; for up to 5 years)	BNGF800A.CCF-e<duration>
Instant Replacement (monthly; for up to 5 years)	BNGF800A.CCF-h<duration>
Warranty extension (monthly; for up to 3 years)	BNGF800A.CCF-we<duration>
Premium Support (monthly; for up to 5 years)	BNGF800A.CCF-p<duration>
Malware Protection (monthly; for up to 5 years)	BNGF800A.CCF-m<duration>
Advanced Threat Protection (monthly; for up to 5 years)	BNGF800A.CCF-a<duration>
Advanced Remote Access (monthly; for up to 5 years)	BNGF800A.CCF-vp<duration>
Firewall Insights (monthly; for up to 5 years)	BNGF800A.CCF-fi<duration>
Spare power supply	BNGIRPS2a
Cold spare F800C.CCF	BNGF800A.CCF--c
Replacement / spare network module 8x1 GbE Copper	BNGM806a
Replacement / spare network module 8x1 GbE SFP	BNGM807a
Replacement / spare network module 4x10 GbE SFP+	BNGM808a
USB modem 4G/LTE (Europe / International)	BNGM40a
USB modem 4G/LTE Instant Replacement (monthly; for up to 5 years)	BNGM40a-h<duration>
USB modem 4G/LTE Warranty extension (monthly; for up to 3 years)	BNGM40a-we<duration>
USB modem 4G/LTE (North America)	BNGM41a
USB modem 4G/LTE Instant Replacement (monthly; for up to 5 years)	BNGM41a-h<duration>
USB modem 4G/LTE Warranty extension (monthly; for up to 3 years)	BNGM41a-we<duration>
USB modem 4G/LTE (Verizon)	BNGM42a
USB modem 4G/LTE Instant Replacement (monthly; for up to 5 years)	BNGM42a-h<duration>
USB modem 4G/LTE Warranty extension (monthly; for up to 3 years)	BNGM42a-we<duration>

CLOUDGEN FIREWALL F900B.CCC	SKU
Barracuda CloudGen Firewall F900B.CCC hardware unit	BNGF900A.CCC
Energize Updates (monthly; for up to 5 years)	BNGF900A.CCC-e<duration>
Instant Replacement (monthly; for up to 5 years)	BNGF900A.CCC-h<duration>
Warranty extension (monthly; for up to 3 years)	BNGF900A.CCC-we<duration>
Premium Support (monthly; for up to 5 years)	BNGF900A.CCC-p<duration>
Malware Protection (monthly; for up to 5 years)	BNGF900A.CCC-m<duration>
Advanced Threat Protection (monthly; for up to 5 years)	BNGF900A.CCC-a<duration>
Advanced Remote Access (monthly; for up to 5 years)	BNGF900A.CCC-vp<duration>
Firewall Insights (monthly; for up to 5 years)	BNGF900A.CCC-fi<duration>
Spare power supply	BNGIRPS2a
Cold spare F900B.CCC	BNGF900A.CCC--c
Replacement / spare network module 8x1 GbE Copper	BNGM806a
Replacement / spare network module 8x1 GbE SFP	BNGM807a
Replacement / spare network module 4x10 GbE SFP+	BNGM808a
Replacement / spare network module 2x40 GbE QSFP+	BNGM809a
USB modem 4G/LTE (Europe / International)	BNGM40a
USB modem 4G/LTE Instant Replacement (monthly; for up to 5 years)	BNGM40a-h<duration>
USB modem 4G/LTE Warranty extension (monthly; for up to 3 years)	BNGM40a-we<duration>
USB modem 4G/LTE (North America)	BNGM41a
USB modem 4G/LTE Instant Replacement (monthly; for up to 5 years)	BNGM41a-h<duration>
USB modem 4G/LTE Warranty extension (monthly; for up to 3 years)	BNGM41a-we<duration>
USB modem 4G/LTE (Verizon)	BNGM42a
USB modem 4G/LTE Instant Replacement (monthly; for up to 5 years)	BNGM42a-h<duration>
USB modem 4G/LTE Warranty extension (monthly; for up to 3 years)	BNGM42a-we<duration>



CLOUDGEN FIREWALL F900B.CCE	SKU
Barracuda CloudGen Firewall F900B.CCE hardware unit	BNGF900A.CCE
Energize Updates (monthly; for up to 5 years)	BNGF900A.CCE-e<duration>
Instant Replacement (monthly; for up to 5 years)	BNGF900A.CCE-h<duration>
Warranty extension (monthly; for up to 3 years)	BNGF900A.CCE-we<duration>
Premium Support (monthly; for up to 5 years)	BNGF900A.CCE-p<duration>
Malware Protection (monthly; for up to 5 years)	BNGF900A.CCE-m<duration>
Advanced Threat Protection (monthly; for up to 5 years)	BNGF900A.CCE-a<duration>
Advanced Remote Access (monthly; for up to 5 years)	BNGF900A.CCE-vp<duration>
Firewall Insights (monthly; for up to 5 years)	BNGF900A.CCE-fi<duration>
Spare power supply	BNGIRPS2a
Cold spare F900B.CCE	BNGF900A.CCE--c
Replacement / spare network module 8x1 GbE Copper	BNGM806a
Replacement / spare network module 8x1 GbE SFP	BNGM807a
Replacement / spare network module 4x10 GbE SFP+	BNGM808a
Replacement / spare network module 2x40 GbE QSFP+	BNGM809a
USB modem 4G/LTE (Europe / International)	BNGM40a
USB modem 4G/LTE Instant Replacement (monthly; for up to 5 years)	BNGM40a-h<duration>
USB modem 4G/LTE Warranty extension (monthly; for up to 3 years)	BNGM40a-we<duration>
USB modem 4G/LTE (North America)	BNGM41a
USB modem 4G/LTE Instant Replacement (monthly; for up to 5 years)	BNGM41a-h<duration>
USB modem 4G/LTE Warranty extension (monthly; for up to 3 years)	BNGM41a-we<duration>
USB modem 4G/LTE (Verizon)	BNGM42a
USB modem 4G/LTE Instant Replacement (monthly; for up to 5 years)	BNGM42a-h<duration>
USB modem 4G/LTE Warranty extension (monthly; for up to 3 years)	BNGM42a-we<duration>

CLOUDGEN FIREWALL F900B.CFE	SKU
Barracuda CloudGen Firewall F900B.CFE hardware unit	BNGF900A.CFE
Energize Updates (monthly; for up to 5 years)	BNGF900A.CFE-e<duration>
Instant Replacement (monthly; for up to 5 years)	BNGF900A.CFE-h<duration>
Warranty extension (monthly; for up to 3 years)	BNGF900A.CFE-we<duration>
Premium Support (monthly; for up to 5 years)	BNGF900A.CFE-p<duration>
Malware Protection (monthly; for up to 5 years)	BNGF900A.CFE-m<duration>
Advanced Threat Protection (monthly; for up to 5 years)	BNGF900A.CFE-a<duration>
Advanced Remote Access (monthly; for up to 5 years)	BNGF900A.CFE-vp<duration>
Firewall Insights (monthly; for up to 5 years)	BNGF900A.CFE-fi<duration>
Spare power supply	BNGIRPS2a
Cold spare F900B.CFE	BNGF900A.CFE--c
Replacement / spare network module 8x1 GbE Copper	BNGM806a
Replacement / spare network module 8x1 GbE SFP	BNGM807a
Replacement / spare network module 4x10 GbE SFP+	BNGM808a
Replacement / spare network module 2x40 GbE QSFP+	BNGM809a
USB modem 4G/LTE (Europe / International)	BNGM40a
USB modem 4G/LTE Instant Replacement (monthly; for up to 5 years)	BNGM40a-h<duration>
USB modem 4G/LTE Warranty extension (monthly; for up to 3 years)	BNGM40a-we<duration>
USB modem 4G/LTE (North America)	BNGM41a
USB modem 4G/LTE Instant Replacement (monthly; for up to 5 years)	BNGM41a-h<duration>
USB modem 4G/LTE Warranty extension (monthly; for up to 3 years)	BNGM41a-we<duration>
USB modem 4G/LTE (Verizon)	BNGM42a
USB modem 4G/LTE Instant Replacement (monthly; for up to 5 years)	BNGM42a-h<duration>
USB modem 4G/LTE Warranty extension (monthly; for up to 3 years)	BNGM42a-we<duration>

CLOUDGEN FIREWALL F900B.CFEQ	SKU
Barracuda CloudGen Firewall F900B.CFEQ hardware unit	BNGF900A.CFEQ
Energize Updates (monthly; for up to 5 years)	BNGF900A.CFEQ-e<duration>
Instant Replacement (monthly; for up to 5 years)	BNGF900A.CFEQ-h<duration>
Warranty extension (monthly; for up to 3 years)	BNGF900A.CFEQ-we<duration>
Premium Support (monthly; for up to 5 years)	BNGF900A.CFEQ-p<duration>
Malware Protection (monthly; for up to 5 years)	BNGF900A.CFEQ-m<duration>
Advanced Threat Protection (monthly; for up to 5 years)	BNGF900A.CFEQ-a<duration>
Advanced Remote Access (monthly; for up to 5 years)	BNGF900A.CFEQ-vp<duration>
Firewall Insights (monthly; for up to 5 years)	BNGF900A.CFEQ-fi<duration>
Spare power supply	BNGIRPS2a
Cold spare F900B.CFEQ	BNGF900A.CFEQ--c
Replacement / spare network module 8x1 GbE Copper	BNGM806a
Replacement / spare network module 8x1 GbE SFP	BNGM807a
Replacement / spare network module 4x10 GbE SFP+	BNGM808a
Replacement / spare network module 2x40 GbE QSFP+	BNGM809a
USB modem 4G/LTE (Europe / International)	BNGM40a
USB modem 4G/LTE Instant Replacement (monthly; for up to 5 years)	BNGM40a-h<duration>
USB modem 4G/LTE Warranty extension (monthly; for up to 3 years)	BNGM40a-we<duration>
USB modem 4G/LTE (North America)	BNGM41a
USB modem 4G/LTE Instant Replacement (monthly; for up to 5 years)	BNGM41a-h<duration>
USB modem 4G/LTE Warranty extension (monthly; for up to 3 years)	BNGM41a-we<duration>
USB modem 4G/LTE (Verizon)	BNGM42a
USB modem 4G/LTE Instant Replacement (monthly; for up to 5 years)	BNGM42a-h<duration>
USB modem 4G/LTE Warranty extension (monthly; for up to 3 years)	BNGM42a-we<duration>

CLOUDGEN FIREWALL F1000B.CE0	SKU
Barracuda CloudGen Firewall F1000B.CE0 hardware unit	BNGF1000B.CE0
Energize Updates (monthly; for up to 5 years)	BNGF1000A.CE0-e<duration>
Instant Replacement (monthly; for up to 5 years)	BNGF1000A.CE0-h<duration>
Warranty extension (monthly; for up to 3 years)	BNGF1000A.CE0-we<duration>
Premium Support (monthly; for up to 5 years)	BNGF1000A.CE0-p<duration>
Malware Protection (monthly; for up to 5 years)	BNGF1000A.CE0-m<duration>
Advanced Threat Protection (monthly; for up to 5 years)	BNGF1000A.CE0-a<duration>
Advanced Remote Access (monthly; for up to 5 years)	BNGF1000A.CE0-vp<duration>
Firewall Insights (monthly; for up to 5 years)	BNGF1000A.CE0-fi<duration>
Cold spare F1000B.CE0	BNGF1000B.CE0--c
USB modem 4G/LTE (Europe / International)	BNGM40a
USB modem 4G/LTE Instant Replacement (monthly; for up to 5 years)	BNGM40a-h<duration>
USB modem 4G/LTE Warranty extension (monthly; for up to 3 years)	BNGM40a-we<duration>
USB modem 4G/LTE (North America)	BNGM41a
USB modem 4G/LTE Instant Replacement (monthly; for up to 5 years)	BNGM41a-h<duration>
USB modem 4G/LTE Warranty extension (monthly; for up to 3 years)	BNGM41a-we<duration>
USB modem 4G/LTE (Verizon)	BNGM42a
USB modem 4G/LTE Instant Replacement (monthly; for up to 5 years)	BNGM42a-h<duration>
USB modem 4G/LTE Warranty extension (monthly; for up to 3 years)	BNGM42a-we<duration>



CLOUDGEN FIREWALL F1000B.CE2	SKU
Barracuda CloudGen Firewall F1000B.CE2 hardware unit	BNGF1000B.CE2
Energize Updates (monthly; for up to 5 years)	BNGF1000A.CE2-e<duration>
Instant Replacement (monthly; for up to 5 years)	BNGF1000A.CE2-h<duration>
Warranty extension (monthly; for up to 3 years)	BNGF1000A.CE2-we<duration>
Premium Support (monthly; for up to 5 years)	BNGF1000A.CE2-p<duration>
Malware Protection (monthly; for up to 5 years)	BNGF1000A.CE2-m<duration>
Advanced Threat Protection (monthly; for up to 5 years)	BNGF1000A.CE2-a<duration>
Advanced Remote Access (monthly; for up to 5 years)	BNGF1000A.CE2-vp<duration>
Firewall Insights (monthly; for up to 5 years)	BNGF1000A.CE2-fi<duration>
Cold spare F1000B.CE0	BNGF1000B.CE2--c
USB modem 4G/LTE (Europe / International)	BNGM40a
USB modem 4G/LTE Instant Replacement (monthly; for up to 5 years)	BNGM40a-h<duration>
USB modem 4G/LTE Warranty extension (monthly; for up to 3 years)	BNGM40a-we<duration>
USB modem 4G/LTE (North America)	BNGM41a
USB modem 4G/LTE Instant Replacement (monthly; for up to 5 years)	BNGM41a-h<duration>
USB modem 4G/LTE Warranty extension (monthly; for up to 3 years)	BNGM41a-we<duration>
USB modem 4G/LTE (Verizon)	BNGM42a
USB modem 4G/LTE Instant Replacement (monthly; for up to 5 years)	BNGM42a-h<duration>
USB modem 4G/LTE Warranty extension (monthly; for up to 3 years)	BNGM42a-we<duration>

CLOUDGEN FIREWALL F1000B.CFEQ	SKU
Barracuda CloudGen Firewall F1000B.CFEQ hardware unit	BNGF1000B.CFEQ
Energize Updates (monthly; for up to 5 years)	BNGF1000A.CFEQ-e<duration>
Instant Replacement (monthly; for up to 5 years)	BNGF1000A.CFEQ-h<duration>
Warranty extension (monthly; for up to 3 years)	BNGF1000A.CFEQ-we<duration>
Premium Support (monthly; for up to 5 years)	BNGF1000A.CFEQ-p<duration>
Malware Protection (monthly; for up to 5 years)	BNGF1000A.CFEQ-m<duration>
Advanced Threat Protection (monthly; for up to 5 years)	BNGF1000A.CFEQ-a<duration>
Advanced Remote Access (monthly; for up to 5 years)	BNGF1000A.CFEQ-vp<duration>
Firewall Insights (monthly; for up to 5 years)	BNGF1000A.CFEQ-fi<duration>
Cold spare F1000B.CFEQ	BNGF1000B.CFEQ--c
USB modem 4G/LTE (Europe / International)	BNGM40a
USB modem 4G/LTE Instant Replacement (monthly; for up to 5 years)	BNGM40a-h<duration>
USB modem 4G/LTE Warranty extension (monthly; for up to 3 years)	BNGM40a-we<duration>
USB modem 4G/LTE (North America)	BNGM41a
USB modem 4G/LTE Instant Replacement (monthly; for up to 5 years)	BNGM41a-h<duration>
USB modem 4G/LTE Warranty extension (monthly; for up to 3 years)	BNGM41a-we<duration>
USB modem 4G/LTE (Verizon)	BNGM42a
USB modem 4G/LTE Instant Replacement (monthly; for up to 5 years)	BNGM42a-h<duration>
USB modem 4G/LTE Warranty extension (monthly; for up to 3 years)	BNGM42a-we<duration>

CLOUDGEN FIREWALL F1000B.CFE	SKU
Barracuda CloudGen Firewall F1000B.CFE hardware unit	BNGF1000B.CFE
Energize Updates (monthly; for up to 5 years)	BNGF1000A.CFE-e<duration>
Instant Replacement (monthly; for up to 5 years)	BNGF1000A.CFE-h<duration>
Warranty extension (monthly; for up to 3 years)	BNGF1000A.CFE-we<duration>
Premium Support (monthly; for up to 5 years)	BNGF1000A.CFE-p<duration>
Malware Protection (monthly; for up to 5 years)	BNGF1000A.CFE-m<duration>
Advanced Threat Protection (monthly; for up to 5 years)	BNGF1000A.CFE-a<duration>
Advanced Remote Access (monthly; for up to 5 years)	BNGF1000A.CFE-vp<duration>
Firewall Insights (monthly; for up to 5 years)	BNGF1000A.CFE-fi<duration>
Cold spare F1000B.CFE	BNGF1000B.CFE--c
USB modem 4G/LTE (Europe / International)	BNGM40a
USB modem 4G/LTE Instant Replacement (monthly; for up to 5 years)	BNGM40a-h<duration>
USB modem 4G/LTE Warranty extension (monthly; for up to 3 years)	BNGM40a-we<duration>
USB modem 4G/LTE (North America)	BNGM41a
USB modem 4G/LTE Instant Replacement (monthly; for up to 5 years)	BNGM41a-h<duration>
USB modem 4G/LTE Warranty extension (monthly; for up to 3 years)	BNGM41a-we<duration>
USB modem 4G/LTE (Verizon)	BNGM42a
USB modem 4G/LTE Instant Replacement (monthly; for up to 5 years)	BNGM42a-h<duration>
USB modem 4G/LTE Warranty extension (monthly; for up to 3 years)	BNGM42a-we<duration>



## Hardware appliances - DIN-rail compatible

CLOUDGEN FIREWALL F93A.R	SKU
Barracuda CloudGen Firewall F93A.R hardware unit	BNGF93A.R
Energize Updates (monthly; for up to 5 years)	BNGF93A.R-e<duration>
Instant Replacement (monthly; for up to 5 years)	BNGF93A.R-h<duration>
Warranty extension (monthly; for up to 3 years)	BNGF93A.R-we<duration>
Premium Support (monthly; for up to 5 years)	BNGF93A.R-p<duration>
Malware Protection (monthly; for up to 5 years)	BNGF93A.R-m<duration>
Advanced Threat Protection (monthly; for up to 5 years)	BNGF93A.R-a<duration>
Advanced Remote Access (monthly; for up to 5 years)	BNGF93A.R-vp<duration>
Firewall Insights (monthly; for up to 5 years)	BNGF93A.R-fi<duration>
Cold spare F93A.R	BNGF93A.R-c
External power supply unit	BNGF93A.PA009
USB modem 4G/LTE (Europe / International)	BNGM40a
USB modem 4G/LTE Instant Replacement (monthly; for up to 5 years)	BNGM40a-h<duration>
USB modem 4G/LTE Warranty extension (monthly; for up to 3 years)	BNGM40a-we<duration>
USB modem 4G/LTE (North America)	BNGM41a
USB modem 4G/LTE Instant Replacement (monthly; for up to 5 years)	BNGM41a-h<duration>
USB modem 4G/LTE Warranty extension (monthly; for up to 3 years)	BNGM41a-we<duration>
USB modem 4G/LTE (Verizon)	BNGM42a
USB modem 4G/LTE Instant Replacement (monthly; for up to 5 years)	BNGM42a-h<duration>
USB modem 4G/LTE Warranty extension (monthly; for up to 3 years)	BNGM42a-we<duration>

CLOUDGEN FIREWALL F193A.R	SKU
Barracuda CloudGen Firewall F193A.R hardware unit	BNGF193A.R
Energize Updates (monthly; for up to 5 years)	BNGF193A.R-e<duration>
Instant Replacement (monthly; for up to 5 years)	BNGF193A.R-h<duration>
Warranty extension (monthly; for up to 3 years)	BNGF193A.R-we<duration>
Premium Support (monthly; for up to 5 years)	BNGF193A.R-p<duration>
Malware Protection (monthly; for up to 5 years)	BNGF193A.R-m<duration>
Advanced Threat Protection (monthly; for up to 5 years)	BNGF193A.R-a<duration>
Advanced Remote Access (monthly; for up to 5 years)	BNGF193A.R-vp<duration>
Firewall Insights (monthly; for up to 5 years)	BNGF193A.R-fi<duration>
Cold spare F193A.R	BNGF193A.R-c
External power supply unit	BNGF193A.PA009
USB modem 4G/LTE (Europe / International)	BNGM40a
USB modem 4G/LTE Instant Replacement (monthly; for up to 5 years)	BNGM40a-h<duration>
USB modem 4G/LTE Warranty extension (monthly; for up to 3 years)	BNGM40a-we<duration>
USB modem 4G/LTE (North America)	BNGM41a
USB modem 4G/LTE Instant Replacement (monthly; for up to 5 years)	BNGM41a-h<duration>
USB modem 4G/LTE Warranty extension (monthly; for up to 3 years)	BNGM41a-we<duration>
USB modem 4G/LTE (Verizon)	BNGM42a
USB modem 4G/LTE Instant Replacement (monthly; for up to 5 years)	BNGM42a-h<duration>
USB modem 4G/LTE Warranty extension (monthly; for up to 3 years)	BNGM42a-we<duration>

SECURE CONNECTOR 20	SKU
Barracuda Secure Connector 20 hardware unit	BNGFSC20a
Pool license Energize Updates (monthly; for up to 5 yrs.)	BNGFSC2p-e<duration>
Instant Replacement (monthly; for up to 5 yrs.)	BNGFSC20a-h<duration>
Warranty Extension (monthly; for up to 3 yrs.)	BNGFSC20a-we<duration>
Power supply	BNGFSCAPSUa

SECURE CONNECTOR 21	SKU
Barracuda Secure Connector 21 hardware unit	BNGFSC21a
Pool license Energize Updates (monthly; for up to 5 yrs.)	BNGFSC2p-e<duration>
Instant Replacement (monthly; for up to 5 yrs.)	BNGFSC21a-h<duration>
Warranty Extension (monthly; for up to 3 yrs.)	BNGFSC21a-we<duration>
Power supply	BNGFSCAPSUa

SECURE CONNECTOR 24 (INTERNATIONAL)	SKU
Barracuda Secure Connector 24 hardware unit	BNGFSC24a
Pool license Energize Updates (monthly; for up to 5 yrs.)	BNGFSC2p-e<duration>
Instant Replacement (monthly; for up to 5 yrs.)	BNGFSC24a-h<duration>
Warranty Extension (monthly; for up to 3 yrs.)	BNGFSC24a-we<duration>
Power supply	BNGFSCAPSUa

SECURE CONNECTOR 25 (INTERNATIONAL)	SKU
Barracuda Secure Connector 25 hardware unit	BNGFSC25a
Pool license Energize Updates (monthly; for up to 5 yrs.)	BNGFSC2p-e<duration>
Instant Replacement (monthly; for up to 5 yrs.)	BNGFSC25a-h<duration>
Warranty Extension (monthly; for up to 3 yrs.)	BNGFSC25a-we<duration>
Power supply	BNGFSCAPSUa

SECURE CONNECTOR 26 (NORTH AMERICA)	SKU
Barracuda Secure Connector 26 hardware unit	BNGFSC26a
Pool license Energize Updates (monthly; for up to 5 yrs.)	BNGFSC2p-e<duration>
Instant Replacement (monthly; for up to 5 yrs.)	BNGFSC26a-h<duration>
Warranty Extension (monthly; for up to 3 yrs.)	BNGFSC26a-we<duration>
Power supply	BNGFSCAPSUa

SECURE CONNECTOR 27 (NORTH AMERICA)	SKU
Barracuda Secure Connector 27 hardware unit	BNGFSC27a
Pool license Energize Updates (monthly; for up to 5 yrs.)	BNGFSC2p-e<duration>
Instant Replacement (monthly; for up to 5 yrs.)	BNGFSC27a-h<duration>
Warranty Extension (monthly; for up to 3 yrs.)	BNGFSC27a-we<duration>
Power supply	BNGFSCAPSUa

SECURE CONNECTOR 28 (NORTH AMERICA / VERIZON)	SKU
Barracuda Secure Connector 28 hardware unit	BNGFSC28a
Pool license Energize Updates (monthly; for up to 5 yrs.)	BNGFSC2p-e<duration>
Instant Replacement (monthly; for up to 5 yrs.)	BNGFSC28a-h<duration>
Warranty Extension (monthly; for up to 3 yrs.)	BNGFSC28a-we<duration>
Power supply	BNGFSCAPSUa

SECURE CONNECTOR 29 (NORTH AMERICA / VERIZON)	SKU
Barracuda Secure Connector 29 hardware unit	BNGFSC29a
Pool license Energize Updates (monthly; for up to 5 yrs.)	BNGFSC2p-e<duration>
Instant Replacement (monthly; for up to 5 yrs.)	BNGFSC29a-h<duration>
Warranty Extension (monthly; for up to 3 yrs.)	BNGFSC29a-we<duration>
Power supply	BNGFSCAPSUa

SECURE CONNECTOR 30	SKU
Barracuda Secure Connector 30 hardware unit	BNGFSC30a
Pool license <a href="#">Energize Updates</a> (monthly; for up to 5 yrs.)	BNGFSC3p-e<duration>
<a href="#">Instant Replacement</a> (monthly; for up to 5 yrs.)	BNGFSC30a-h<duration>
<a href="#">Warranty Extension</a> (monthly; for up to 3 yrs.)	BNGFSC30a-we<duration>
Power supply	BNGFSCAPSUa

SECURE CONNECTOR 31	SKU
Barracuda Secure Connector 31 hardware unit	BNGFSC31a
Pool license <a href="#">Energize Updates</a> (monthly; for up to 5 yrs.)	BNGFSC3p-e<duration>
<a href="#">Instant Replacement</a> (monthly; for up to 5 yrs.)	BNGFSC31a-h<duration>
<a href="#">Warranty Extension</a> (monthly; for up to 3 yrs.)	BNGFSC31a-we<duration>
Power supply	BNGFSCAPSUa

SECURE CONNECTOR 34	SKU
Barracuda Secure Connector 34 hardware unit	BNGFSC34a
Pool license <a href="#">Energize Updates</a> (monthly; for up to 5 yrs.)	BNGFSC3p-e<duration>
<a href="#">Instant Replacement</a> (monthly; for up to 5 yrs.)	BNGFSC34a-h<duration>
<a href="#">Warranty Extension</a> (monthly; for up to 3 yrs.)	BNGFSC34a-we<duration>
Power supply	BNGFSCAPSUa

SECURE CONNECTOR 35	SKU
Barracuda Secure Connector 35 hardware unit	BNGFSC35a
Pool license <a href="#">Energize Updates</a> (monthly; for up to 5 yrs.)	BNGFSC3p-e<duration>
<a href="#">Instant Replacement</a> (monthly; for up to 5 yrs.)	BNGFSC35a-h<duration>
<a href="#">Warranty Extension</a> (monthly; for up to 3 yrs.)	BNGFSC35a-we<duration>
Power supply	BNGFSCAPSUa



## Virtual Appliances

BARRACUDA CLOUDGEN FIREWALL VX	SKU
Barracuda CloudGen Firewall VF10, VF25, VF50, VF100, VF250, VF500, VF1000, VF2000, VF4000, VF8000	BNGVF10a,...BNGVF8000a
<a href="#">Energize Updates</a> (monthly; for up to 5 years)	BNGVF<user>-e<duration>, e.g., BNGVF25a-e12
<a href="#">Premium Support</a> (monthly; for up to 5 years)	BNGVF<user>-p<duration>, e.g., BNGVF25a-p12
<a href="#">Malware Protection</a> (monthly; for up to 5 years)	BNGVF<user>-m<duration>, e.g., BNGVF25a-m12
<a href="#">Advanced Threat Protection</a> (monthly; for up to 5 years)	BNGVF<user>-a<duration>, e.g., BNGVF25a-a12
<a href="#">Advanced Remote Access</a> (monthly; for up to 5 years)	BNGVF<user>-vp<duration>, e.g., BNGVF25a-vp12
<a href="#">Firewall Insights</a> (monthly; for up to 5 years)	BNGVF<user>-fi<duration>, e.g., BNGVF25a-fi12

## Amazon Web Services (AWS)

FOR AMAZON WEB SERVICE ACCOUNT LEVEL 2	SKU
Barracuda CloudGen Firewall for Amazon Web Service Account Lvl 2	BNGCAW002a
Virtual subscription (incl. <a href="#">Energize Updates</a> ; monthly; for up to 5 years)	BNGCAW002a-v<duration>
<a href="#">Malware Protection</a> (monthly; for up to 5 years)	BNGCAW002a-m<duration>
<a href="#">Advanced Threat Protection</a> (monthly; for up to 5 years)	BNGCAW002a-a<duration>
<a href="#">Advanced Remote Access</a> (monthly; for up to 5 years)	BNGCAW002a-vp<duration>
<a href="#">Firewall Insights</a> (monthly; for up to 5 years)	BNGCAW002a-fi<duration>
<a href="#">Premium Support</a> (monthly; for up to 5 years)	BNGCAW002a-p<duration>

FOR AMAZON WEB SERVICE ACCOUNT LEVEL 6	SKU
Barracuda CloudGen Firewall for Amazon Web Service Account Lvl 6	BNGCAW006a
Virtual subscription (incl. <a href="#">Energize Updates</a> ; monthly; for up to 5 years)	BNGCAW006a-v<duration>
<a href="#">Malware Protection</a> (monthly; for up to 5 years)	BNGCAW006a-m<duration>
<a href="#">Advanced Threat Protection</a> (monthly; for up to 5 years)	BNGCAW006a-a<duration>
<a href="#">Advanced Remote Access</a> (monthly; for up to 5 years)	BNGCAW006a-vp<duration>
<a href="#">Firewall Insights</a> (monthly; for up to 5 years)	BNGCAW006a-fi<duration>
<a href="#">Premium Support</a> (monthly; for up to 5 years)	BNGCAW006a-p<duration>

FOR AMAZON WEB SERVICE ACCOUNT LEVEL 4	SKU
Barracuda CloudGen Firewall for Amazon Web Service Account Lvl 4	BNGCAW004a
Virtual subscription (incl. <a href="#">Energize Updates</a> ; monthly; for up to 5 years)	BNGCAW004a-v<duration>
<a href="#">Malware Protection</a> (monthly; for up to 5 years)	BNGCAW004a-m<duration>
<a href="#">Advanced Threat Protection</a> (monthly; for up to 5 years)	BNGCAW004a-a<duration>
<a href="#">Advanced Remote Access</a> (monthly; for up to 5 years)	BNGCAW004a-vp<duration>
<a href="#">Firewall Insights</a> (monthly; for up to 5 years)	BNGCAW004a-fi<duration>
<a href="#">Premium Support</a> (monthly; for up to 5 years)	BNGCAW004a-p<duration>

FOR AMAZON WEB SERVICE ACCOUNT LEVEL 8	SKU
Barracuda CloudGen Firewall for Amazon Web Service Account Lvl 8	BNGCAW008a
Virtual subscription (incl. <a href="#">Energize Updates</a> ; monthly; for up to 5 years)	BNGCAW008a-v<duration>
<a href="#">Malware Protection</a> (monthly; for up to 5 years)	BNGCAW008a-m<duration>
<a href="#">Advanced Threat Protection</a> (monthly; for up to 5 years)	BNGCAW008a-a<duration>
<a href="#">Advanced Remote Access</a> (monthly; for up to 5 years)	BNGCAW008a-vp<duration>
<a href="#">Firewall Insights</a> (monthly; for up to 5 years)	BNGCAW008a-fi<duration>
<a href="#">Premium Support</a> (monthly; for up to 5 years)	BNGCAW008a-p<duration>

## Microsoft Azure

FOR MICROSOFT AZURE ACCOUNT LEVEL 2	SKU
Barracuda CloudGen Firewall for Microsoft Azure Account Lvl 2	BNGCAZ002a
Virtual subscription (incl. <a href="#">Energize Updates</a> ; monthly; for up to 5 years)	BNGCAZ002a-v<duration>
<a href="#">Malware Protection</a> (monthly; for up to 5 years)	BNGCAZ002a-m<duration>
<a href="#">Advanced Threat Protection</a> (monthly; for up to 5 years)	BNGCAZ002a-a<duration>
<a href="#">Advanced Remote Access</a> (monthly; for up to 5 years)	BNGCAZ002a-vp<duration>
<a href="#">Firewall Insights</a> (monthly; for up to 5 years)	BNGCAZ002a-fi<duration>
<a href="#">Premium Support</a> (monthly; for up to 5 years)	BNGCAZ002a-p<duration>

FOR MICROSOFT AZURE ACCOUNT LEVEL 6	SKU
Barracuda CloudGen Firewall for Microsoft Azure Account Lvl 6	BNGCAZ006a
Virtual subscription (incl. <a href="#">Energize Updates</a> ; monthly; for up to 5 years)	BNGCAZ006a-v<duration>
<a href="#">Malware Protection</a> (monthly; for up to 5 years)	BNGCAZ006a-m<duration>
<a href="#">Advanced Threat Protection</a> (monthly; for up to 5 years)	BNGCAZ006a-a<duration>
<a href="#">Advanced Remote Access</a> (monthly; for up to 5 years)	BNGCAZ006a-vp<duration>
<a href="#">Firewall Insights</a> (monthly; for up to 5 years)	BNGCAZ006a-fi<duration>
<a href="#">Premium Support</a> (monthly; for up to 5 years)	BNGCAZ006a-p<duration>

FOR MICROSOFT AZURE ACCOUNT LEVEL 4	SKU
Barracuda CloudGen Firewall for Microsoft Azure Account Lvl 4	BNGICAZ004a
Virtual subscription (incl. <a href="#">Energize Updates</a> ; monthly; for up to 5 years)	BNGICAZ004a-v<duration>
<a href="#">Malware Protection</a> (monthly; for up to 5 years)	BNGICAZ004a-m<duration>
<a href="#">Advanced Threat Protection</a> (monthly; for up to 5 years)	BNGICAZ004a-a<duration>
<a href="#">Advanced Remote Access</a> (monthly; for up to 5 years)	BNGICAZ004a-vp<duration>
<a href="#">Firewall Insights</a> (monthly; for up to 5 years)	BNGICAZ004a-fi<duration>
<a href="#">Premium Support</a> (monthly; for up to 5 years)	BNGICAZ004a-p<duration>

FOR MICROSOFT AZURE ACCOUNT LEVEL 8	SKU
Barracuda CloudGen Firewall for Microsoft Azure Account Lvl 8	BNGCAZ008a
Virtual subscription (incl. <a href="#">Energize Updates</a> ; monthly; for up to 5 years)	BNGCAZ008a-v<duration>
<a href="#">Malware Protection</a> (monthly; for up to 5 years)	BNGCAZ008a-m<duration>
<a href="#">Advanced Threat Protection</a> (monthly; for up to 5 years)	BNGCAZ008a-a<duration>
<a href="#">Advanced Remote Access</a> (monthly; for up to 5 years)	BNGCAZ008a-vp<duration>
<a href="#">Firewall Insights</a> (monthly; for up to 5 years)	BNGCAZ008a-fi<duration>
<a href="#">Premium Support</a> (monthly; for up to 5 years)	BNGCAZ008a-p<duration>

## Google Cloud Platform

FOR GOOGLE CLOUD - LEVEL 2	SKU
Barracuda CloudGen Firewall for Google Cloud - Lvl 2	BNGCLD002a
Virtual subscription (incl. <a href="#">Energize Updates</a> ; monthly; for up to 5 years)	BNGCLD002a-v<duration>
<a href="#">Malware Protection</a> (monthly; for up to 5 years)	BNGCLD002a-m<duration>
<a href="#">Advanced Threat Protection</a> (monthly; for up to 5 years)	BNGCLD002a-a<duration>
<a href="#">Advanced Remote Access</a> (monthly; for up to 5 years)	BNGCLD002a-vp<duration>
<a href="#">Firewall Insights</a> (monthly; for up to 5 years)	BNGCLD002a-fi<duration>
<a href="#">Premium Support</a> (monthly; for up to 5 years)	BNGCLD002a-p<duration>

FOR GOOGLE CLOUD - LEVEL 6	SKU
Barracuda CloudGen Firewall for Google Cloud - Lvl 6	BNGCLD006a
Virtual subscription (incl. <a href="#">Energize Updates</a> ; monthly; for up to 5 years)	BNGCLD006a-v<duration>
<a href="#">Malware Protection</a> (monthly; for up to 5 years)	BNGCLD006a-m<duration>
<a href="#">Advanced Threat Protection</a> (monthly; for up to 5 years)	BNGCLD006a-a<duration>
<a href="#">Advanced Remote Access</a> (monthly; for up to 5 years)	BNGCLD006a-vp<duration>
<a href="#">Firewall Insights</a> (monthly; for up to 5 years)	BNGCLD006a-fi<duration>
<a href="#">Premium Support</a> (monthly; for up to 5 years)	BNGCLD006a-p<duration>

FOR GOOGLE CLOUD - LEVEL 4	SKU
Barracuda CloudGen Firewall for Google Cloud - Lvl 4	BNGCLD004a
Virtual subscription (incl. <a href="#">Energize Updates</a> ; monthly; for up to 5 years)	BNGCLD004a-v<duration>
<a href="#">Malware Protection</a> (monthly; for up to 5 years)	BNGCLD004a-m<duration>
<a href="#">Advanced Threat Protection</a> (monthly; for up to 5 years)	BNGCLD004a-a<duration>
<a href="#">Advanced Remote Access</a> (monthly; for up to 5 years)	BNGCLD004a-vp<duration>
<a href="#">Firewall Insights</a> (monthly; for up to 5 years)	BNGCLD004a-fi<duration>
<a href="#">Premium Support</a> (monthly; for up to 5 years)	BNGCLD004a-p<duration>

FOR GOOGLE CLOUD - LEVEL 8	SKU
Barracuda CloudGen Firewall for Google Cloud - Lvl 8	BNGCLD008a
Virtual subscription (incl. <a href="#">Energize Updates</a> ; monthly; for up to 5 years)	BNGCLD008a-v<duration>
<a href="#">Malware Protection</a> (monthly; for up to 5 years)	BNGCLD008a-m<duration>
<a href="#">Advanced Threat Protection</a> (monthly; for up to 5 years)	BNGCLD008a-a<duration>
<a href="#">Advanced Remote Access</a> (monthly; for up to 5 years)	BNGCLD008a-vp<duration>
<a href="#">Firewall Insights</a> (monthly; for up to 5 years)	BNGCLD008a-fi<duration>
<a href="#">Premium Support</a> (monthly; for up to 5 years)	BNGCLD008a-p<duration>



# Barracuda Firewall Control Center

## Virtual Edition

FIREWALL CONTROL CENTER VC400	SKU
Barracuda Firewall Control Center VC400 - Standard Edition	BNCVC400a
<a href="#">Energize Updates</a> (monthly; for up to 5 years)	BNCVC400a-e<duration>
<a href="#">Premium Support</a> (monthly; for up to 5 years)	BNCVC400a-p<duration>

FIREWALL CONTROL CENTER VC610	SKU
Barracuda Firewall Control Center VC610 - Enterprise Edition	BNCVC610a
<a href="#">Energize Updates</a> (monthly; for up to 5 years)	BNCVC610a-e<duration>
<a href="#">Premium Support</a> (monthly; for up to 5 years)	BNCVC610a-p<duration>

FIREWALL CONTROL CENTER VC820	SKU
Barracuda Firewall Control Center VC820 - Global Edition	BCCVC820a
<a href="#">Energize Updates</a> (monthly; for up to 5 years)	BCCVC820a-e<duration>
<a href="#">Premium Support</a> (monthly; for up to 5 years)	BCCVC820a-p<duration>
Additional Tenant (Range) for Firewall Control Center VC820 (monthly)	BNC-b1

## Microsoft Azure

FIREWALL CONTROL CENTER VCC400	SKU
Barracuda Firewall Control Center VCC400 - Standard Edition	BNCCAZ400a
Virtual subscription (incl. <a href="#">Energize Updates</a> ; monthly; for up to 5 years)	BNCCAZ400a-v<duration>
<a href="#">Premium Support</a> (monthly; for up to 5 years)	BNCCAZ400a-p<duration>

FIREWALL CONTROL CENTER VCC610	SKU
Barracuda Firewall Control Center VCC610 - Enterprise Edition	BNCCAZ610a
Virtual subscription (incl. <a href="#">Energize Updates</a> ; monthly; for up to 5 years)	BNCCAZ610a-v<duration>
<a href="#">Premium Support</a> (monthly; for up to 5 years)	BNCCAZ610a-p<duration>

## Amazon Web Services (AWS)

FIREWALL CONTROL CENTER VCC400	SKU
Barracuda Firewall Control Center VCC400 - Standard Edition	BNCCAW400a
Virtual subscription (incl. <a href="#">Energize Updates</a> ; monthly; for up to 5 years)	BNCCAW400a-v<duration>
<a href="#">Premium Support</a> (monthly; for up to 5 years)	BNCCAW400a-p<duration>

FIREWALL CONTROL CENTER VCC610	SKU
Barracuda Firewall Control Center VCC610 - Enterprise Edition	BNCCAW610a
Virtual subscription (incl. <a href="#">Energize Updates</a> ; monthly; for up to 5 years)	BNCCAW610a-v<duration>
<a href="#">Premium Support</a> (monthly; for up to 5 years)	BNCCAW610a-p<duration>

## Google Cloud Platform (GCP)

FIREWALL CONTROL CENTER VCC400	SKU
Barracuda Firewall Control Center VCC400 - Standard Edition	BNCCLD400a
Virtual subscription (incl. <a href="#">Energize Updates</a> ; monthly; for up to 5 years)	BNCCLD400a-v<duration>
<a href="#">Premium Support</a> (monthly; for up to 5 years)	BNCCLD400a-p<duration>

FIREWALL CONTROL CENTER VCC610	SKU
Barracuda Firewall Control Center VCC610 - Enterprise Edition	BNCCLD610a
Virtual subscription (incl. <a href="#">Energize Updates</a> ; monthly; for up to 5 years)	BNCCLD610a-v<duration>
<a href="#">Premium Support</a> (monthly; for up to 5 years)	BNCCLD610a-p<duration>

# Barracuda Firewall Insights

## Firewall Insights Server (Virtual Edition)

FIREWALL INSIGHTS SERVER	SKU
Firewall Insights Server	BNGFISa

## Firewall Insights Server Subscription

FIREWALL INSIGHTS SERVER SUBSCRIPTION	SKU
Firewall Insights Server Subscription (monthly; for up to 5 years)	BNGFISa-e<duration>

# Certificates



## CE Declaration of Conformity Barracuda Networks

We,

**Manufacturer's Name:** Barracuda Networks  
**Manufacturer's Address:** 5225 Hellyer Ave. Suite 150  
San Jose, CA 95138  
USA

Hereby, declare under our sole responsibility that the requirements set out in the Directives 2014/35/EU, 2014/30/EU, 2014/53/2014, 2011/65/EU, 2012/19/EU has been fully fulfilled on our product indication below:

### Barracuda CloudGen Firewall

The object of the declaration described above is in conformity with the relevant Union harmonization legislation:

**Electrical Safety (LVD) 2014/35/EU**  
**Electromagnetic compatibility directive (EMC) 2014/30/EU**  
**Radio Equipment Directive (RED) 2014/53/EU**  
**Restriction of Hazardous Substances Directive (RoHS) 2011/65/EU**  
**Waste Electrical and Electronic Equipment Directive (WEEE) 2012/19/EU**

The following standards and technical specifications have been applied:

**EN 55032:2015 + AC:2016 Class A**  
**EN 55024:2010+AS:2015 Class A**  
**EN 61000-3-2:2014 Class A**  
**EN 61000-3-3:2013**  
**EN 300 328 V2.1.1**  
**EN 301 893 V2.1.1**  
**EN 301 489-1 V2.2.0**  
**EN 301 489-17 V3.2.0**  
**EN 62311:2008**  
**EN 60950-1:2006+A11:2009+A1:2010+A12:2011+A2:2013**

Signed for and on behalf of:

Signature, Date, Place :  February 1, 2019, USA  
Name and Job Title : Ken Martin / SVP, World Wide Manufacturing Ops.





February 21, 2020

To Whom It May Concern:

Barracuda Networks Inc. ("Barracuda") hereby confirm that the Barracuda CloudGen Firewall complies with the UN Manual Test and Criteria, Part III, subsection 38.3, Revision 6, Amendment 1 (38.3). This is based on documents gathered from our supply chain which integrates the lithium cell battery into the system.

Thank you for your attention to this matter.

Best Regards,

A handwritten signature in black ink, appearing to read "Ken Martin", is written over a light grey rectangular background.

Ken Martin  
SVP Worldwide Manufacturing Operations  
Barracuda Networks Inc.



Document version 4.6  
Applies for firmware version 8.3.x

Barracuda Networks, Inc.  
[barracuda.com](http://barracuda.com)